



USB™
VISION

Manual EXO series

**exo694*U3, exo695*U3, exo814*U3, exo815*U3,
exo834*U3**

Company Information

SVS-VISTEK GMBH

Mühlbachstr. 20
82229 Seefeld
Germany

Tel.: +49 (0) 81 52 9985-0
Fax: +49 (0) 81 52 9985-79
Mail: info@svs-vistek.com
Web: <http://www.svs-vistek.com>

This Operation Manual is based on the following standards:

DIN EN 62079
DIN EN ISO 12100
ISO Guide 37
DIN ISO 3864-2
DIN ISO 3864-4

This Operation Manual contains important instructions for safe and efficient handling of SVCam Cameras (hereinafter referred to as „camera“). This Operating Manual is part of the camera and must be kept accessible in the immediate vicinity of the camera for any person working on or with this camera.

Read carefully and make sure you understand this Operation Manual prior to starting any work with this camera. The basic prerequisite for safe work is compliant with all specified safety and handling instructions.

Accident prevention guidelines and general safety regulations should be applied.

Illustrations in this Operation Manual are provided for basic understanding and can vary from the actual model of this camera. No claims can be derived from the illustrations in this Operation Manual.

The camera in your possession has been produced with great care and has been thoroughly tested. Nonetheless, should you have reasons for complaint, then please contact your local SVS-VISTEK distributor. You will find a list of distributors in your area under: <http://www.svs-vistek.com/company/distributors/distributors.php>

Copyright Protection Statement

(as per DIN ISO 16016:2002-5)

Forwarding and duplicating of this document, as well as using or revealing its contents are prohibited without written approval. All rights reserved with regard to patent claims or submission of design or utility patent.

Contents

1	Safety Messages	5
2	Legal Information.....	6
3	The EXO	7
3.1	Building blocks simplify design-in.....	7
3.1.1	Exclusive body architecture	7
3.1.2	Form follows requirements.....	7
3.2	The EXO with USB3 Vision.....	7
3.3	4IO adds Light and Functionality.....	9
4	Getting Started	10
4.1	Power supply.....	10
4.2	USB Flashing LED Codes	10
4.3	Software.....	11
4.3.1	SVCapture 2.x	11
4.4	Driver Circuit Schematics	18
5	Connectors	19
5.1	USB3 Vision.....	19
5.2	Input / output connectors.....	19
6	Dimensions	21
6.1	exo694*U3, exo814*U3, exo834*U3.....	21
6.2	C & CS Mount	25
7	Feature-Set	26
7.1	Basic Understanding.....	26
7.1.1	Basic Understanding of CCD Technology	26
7.1.2	Interline Transfer	27
7.1.3	Global Shutter / Progressive Scan	28
7.1.4	Frames per Second	29
7.1.5	Acquisition and Processing Time	29
7.1.6	Exposure.....	30
7.1.7	Auto Luminance.....	30
7.1.8	Bit-Depth	31
7.1.9	Color.....	33
7.1.10	Resolution – active & effective	34
7.1.11	Offset	35
7.1.12	Gain.....	36
7.1.13	Image Flip.....	37
7.1.14	Binning	38
7.1.15	Decimation	39
7.1.16	Burst Mode	39

7.2	Camera Features	41
7.2.1	Standard Tap Geometries.....	41
7.2.2	Tap Structure.....	41
7.2.3	Tap Balancing.....	42
7.2.4	System Clock Frequency.....	44
7.2.5	Temperature Sensor.....	44
7.2.6	Basic Capture Modes.....	45
7.2.7	LookUp Table.....	48
7.2.8	ROI / AOI.....	50
7.3	I/O Features	50
7.3.1	Assigning I/O Lines – IOMUX.....	50
7.3.2	Strobe Control.....	57
7.3.3	Sequencer.....	64
7.3.4	PWM.....	66
7.3.5	Optical Input.....	67
7.3.6	PLC/Logical Operation on Inputs.....	69
7.3.7	Serial data interfaces.....	70
7.3.8	Trigger-Edge Sensitivity.....	73
7.3.9	Debouncing Trigger Signals.....	73
7.3.10	Prescale.....	75
7.4	IR Cut Filter	76
8	Specifications	78
8.1	EXO694*U3.....	79
8.2	EXO695*U3.....	82
8.3	EXO814*U3.....	85
8.4	EXO815*U3.....	88
8.5	EXO834*U3.....	91
9	Terms of warranty	94
10	Troubleshooting	96
10.1	FAQ.....	96
10.2	Support Request Form / Check List.....	97
11	IP protection classes	99
12	Glossary of Terms	101
13	Index of figures	104
14	Index	107

1 Safety Messages

The classification of hazards is made pursuant to ISO 3864-2 and ANSI Y535.6 with the help of key words.

This Operating Manual uses the following Safety Messages:









Risk of death or serious injury		DANGER! Danger indicates a hazard with a high level of risk which, if not avoided will result in death or serious injury.
		WARNING! Warning indicates a hazard with a medium level of risk which, if not avoided will result in death or serious injury.
		CAUTION! Caution indicates a hazard with a low level of risk which, if not avoided will result in death or serious injury.
Risk of damage		PROHIBITION! A black graphical symbol inside a red circular band with a red diagonal bar defines a safety sign that indicates that an action shall not be taken or shall be stopped.
		CAUTION! A black graphical symbol inside a yellow triangle defines a safety sign that indicates a hazard.
		MANDATORY ACTION! A white graphical symbol inside a blue circle defines a safety sign that indicates that an action shall be taken to avoid a hazard.
Cross-reference 		NOTICE Provides references and tips

FIGURE 1: TABLE OF SAFETY MESSAGES

2 Legal Information

Information given within the manual accurate as to: February 23, 2017, errors and omissions excepted.

These products are designed for industrial applications only. Cameras from SVS-Vistek are not designed for life support systems where malfunction of the products might result in any risk of personal harm or injury. Customers, integrators and end users of SVS-Vistek products might sell these products and agree to do so at their own risk, as SVS-Vistek will not take any liability for any damage from improper use or sale.



Europe

This camera is CE tested, rules of EN 55022:2010+AC2011 and EN61000-6-2:2005 apply.

All SVS-VISTEK cameras comply with the recommendation of the European Union concerning RoHS Rules

USA and Canada

This device complies with part 15 of the FCC Rules. Operation is subject to the following conditions: (1) This device may not cause harmful interference, and (2) this device must accept any interference received, including interference that may cause undesired operation.

Note: This equipment has been tested and found to comply with the limits for a Class A digital device, pursuant to part 15 of the FCC Rules. These limits are designed to provide reasonable protection against harmful interference when the equipment is operated in a commercial environment. This equipment generates, uses, and can radiate radio frequency energy and, if not installed and used in accordance with the instruction manual, may cause harmful interference to radio communications. Operation of this equipment in a residential area is likely to cause harmful interference in which case the user will be required to correct the interference at its own expense.

It is necessary to use a shielded power supply cable. You can then use the "shield contact" on the connector which has GND contact to the camera housing. This is essential for any use. If not done and camera is destroyed due to Radio Magnetic Interference (RMI) **WARRANTY is void!**

- **Power:** US/UK and European line adapter can be delivered. Otherwise use filtered and stabilized DC power supply.
- Shock & Vibration Resistance is tested: For detailed Specifications refer to Specification.

3 The EXO

The EXO series features a perfect match with its sophisticated, rugged unibody housing and rich camera feature set, combined with industry standard interfaces such as GigE Vision, Camera Link and USB3 Vision. A smart solution for virtually any application, allowing smooth and effortless up- or downscaling of machine vision applications. The EXO is easy to integrate and comes with a full package of useful hardware features.

The EXO series features a perfect match with its sophisticated, rugged unibody housing and rich camera feature set, combined with industry standard interfaces such as GigE Vision, Camera Link and USB3 Vision. A smart solution for virtually any application, allowing smooth and effortless up- or downscaling of machine vision applications. The EXO is easy to integrate and comes with a full package of useful hardware features.

3.1 Building blocks simplify design-in

3.1.1 Exclusive body architecture

The EXO-Series comes in a new 50 x 50 mm aluminum body. The elaborate, high precision machined unibody housing ensures perfect temperature distribution even for the most demanding sensors. The electric circuitry of the EXO is optimized for low power dissipation, helped by the excellent temperature performance of the housing. The EXO features the latest global shutter CMOS and CCD sensors from SONY, CMOSIS and ON Semi.

3.1.2 Form follows requirements

A uniform form factor and identical standard interface connectors with identical pinout facilitate interchangeability, allowing system integrators to adapt applications with varying conditions and requirements very quickly with minimum design effort. The massive lens mount is designed to keep any kind of lens in its proper position.

3.2 The EXO with USB3 Vision

is one of the most flexible and scalable cameras for the industrial market segment. The USB3 Vision interface is easy to integrate in your system, with a data rate up to effective 350 MB/sec. Power the camera via the interface and reduce cable complexity.

- > Up to 640 MB/sec effective transfer rate
- > Leverages existing infrastructure for cables and connectors
- > Camera power dissipation below 4 W
- > GenICam compliant
- > Cost effective / Easy implementation and interfacing



USB3 issues

Make sure your USB3 hardware is able to transfer the high data rates your camera delivers.

In Theory, USB3.0 transfer rate is 5Gbps, USB3.1 even can transfer 10Gbps.

Despite being standardized, we find a significant amount of USB3 hardware being sold still is not capable to cope with these high data rates. This refers to some USB3 host chipsets, USB hubs as well to high processing load in the host computer. An integrated hardware buffer in



the SVS-Vistek camera (240MB) will try to catch and buffer these cases. Burst Mode frame rate is limited to maximum USB speed. The SVCapture GUI will show the real data rate of successful transfers. If you encounter image losses, it might be worthwhile to run the same camera task with different USB chipsets and/or processor.

Generally,

- > use a dedicated USB3 port at your computer
 - > do not use USB3 hubs for your image USB stream
 - > connect only the camera to this USB3 port
 - > in case of image drops, try different hardware or reduce frame rate
- If the client hardware is too slow (processing load) the above is valid as well.

3.3 4IO adds Light and Functionality

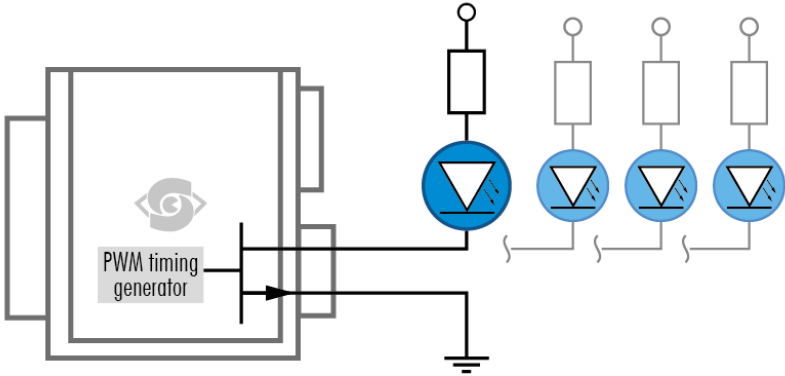

Figure 2: Illustration of 4IO concept of switching LEDs

Your SVS-Vistek camera is

equipped with the innovative 4IO-interface allowing full light control, replacing external strobe controllers. Each of the 4 outputs can be individually configured and managed using pulse-width modulation. With its high current output, the camera is able to drive LED lights directly without external light controller.

If you attach any light to the camera, make sure the power supply has enough power not to fail when the camera is putting light ON.

The integrated sequencer allows multiple exposures with settings to be programmed, creating new and cost effective options. Logical functions like AND / OR are supported.

- > 4 x open drain high power OUT
- > 4 x high voltage IN – TTL up to 25 Volts
- > Power MOSFET transistors
- > PWM strobe control
- > Sequencer for various configurations
- > PLC functionality with AND, OR and timers
- > Safe Trigger (debouncer, prescaler, high low trigger)

4 Getting Started

4.1 Power supply

Connect the power supply.



CAUTION! – This camera does not support hotplugging

1. First, connect the data cable.
2. Then connect power supply.

When using your own power supply (e.g. 10 -25 V DC) see also Hirose 12-pin for a detailed pin layout of the power connector. For power input specifications refer to specifications.

4.2 USB Flashing LED Codes

On power up, the camera will indicate its current status with a flashing LED on its back. The LED will change color and rhythm.

The meaning of the blinking codes translates as follows:









Flashing	Description
 Yellow slow (1Hz)	No Connection
 Yellow permanent	Network address assigned
 Green slow (1Hz)	Streaming channel available
 Green quickly (8 Hz)	Acquisition enabled
 Red slow (1 Hz)	Problem with initialization
 Red quickly (8 Hz)	Camera overheating
 Blue permanent	Waiting for trigger
 Cyan permanent	Exposure active
 Violet permanent	Readout/FVAL

Table 1 table of flashing LED codes

4.3 Software

Further information, documentations, release notes, latest software and application manuals can be downloaded in the download area on:

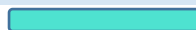
<https://www.svs-vistek.com/en/login/svs-loginarea-login.php>

Depending on the type of camera you bought, several software packages apply.

4.3.1 SVCapture 2.x

Your SVCam combined software installer including:

- > SVCapture 2.x
(a viewer/controler program for SVCam USB3 cameras)
- > PC USB3 driver & filter driver
- > TL_Driver
(GenICam drivers and transport layer DDLs)

SVCapture 2.x is a XML based software tool provided for free. It is created to show the capabilities of your SVS-Vistek camera and to show/modify values to your cam.

Get control of exposure timing, trigger delay, image correction etc. or control up to 4 LED lights connected to the SVCam directly via the PC. Use the built-in sequencer to program several intervals executed by one single trigger impulse.

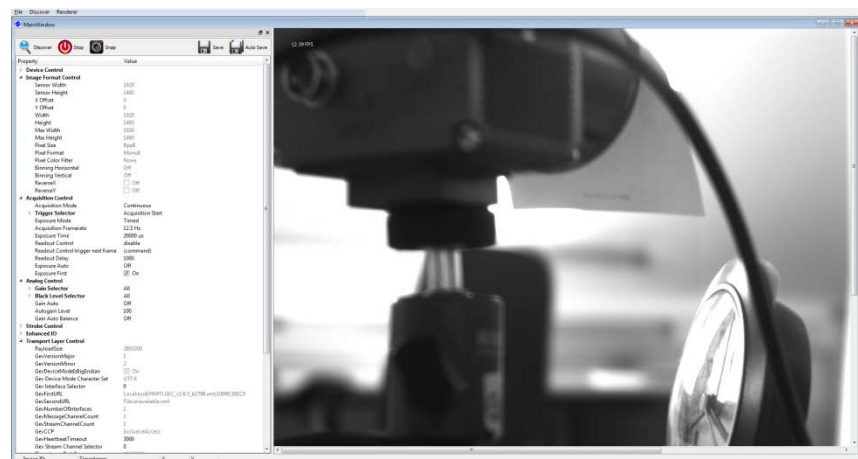
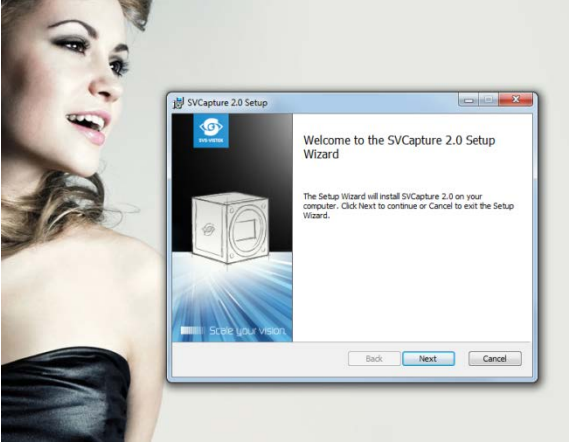

Figure 3: Screenshot of SVCapture 2.x

Installation

Installation process may differ from PC to PC. It is recommended to install the whole software package.

1. Copy/expand the installation executable file to your hard drive.
2. Run installation



3. Read and accept the terms of license agreement

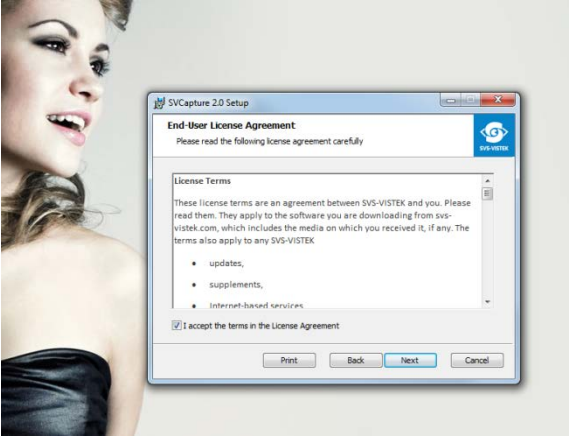

4. Choose destination folder

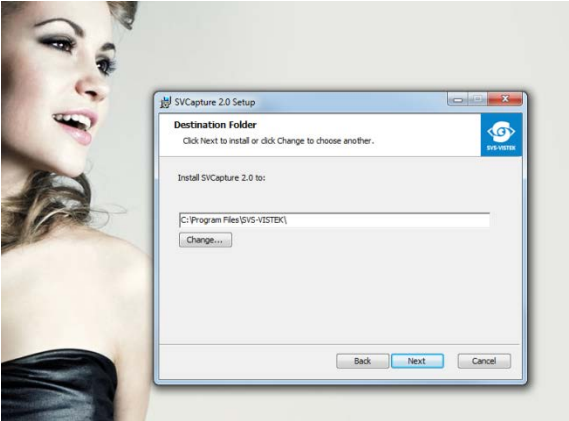

5. Install the USB 3.0 Driver

Generic driver included in the windows system will not match all SVS-VISTEK USB3 Vision features.

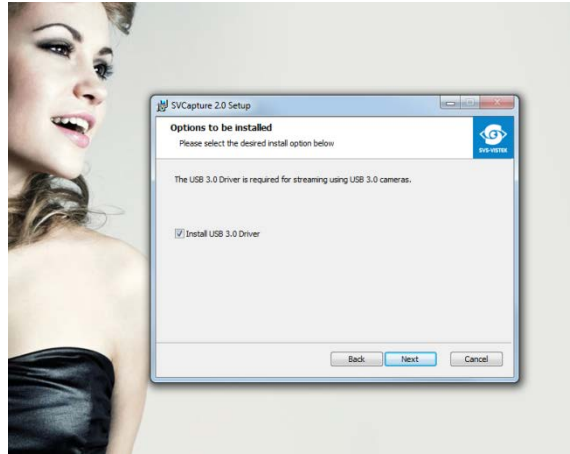

6. Start installation

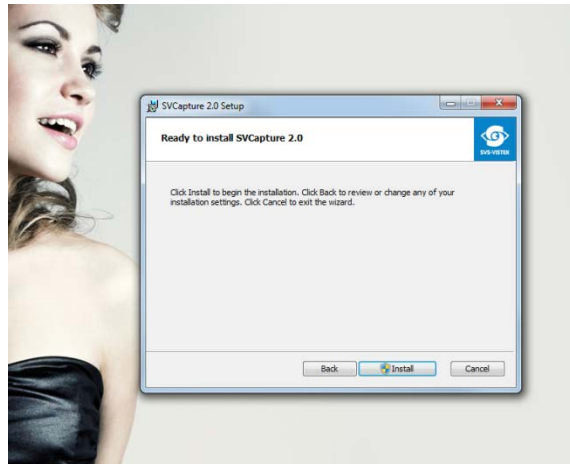

7. System, warning

The installer will modify your system (USB 3.0 driver); there for windows systems will warn you with an interrupt.



Accept system modification

Installation will proceed

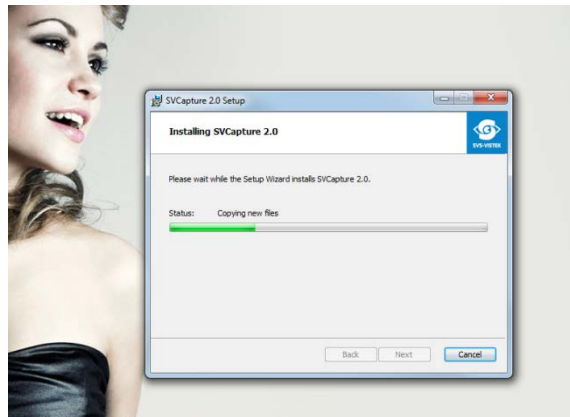

8. Installation completed

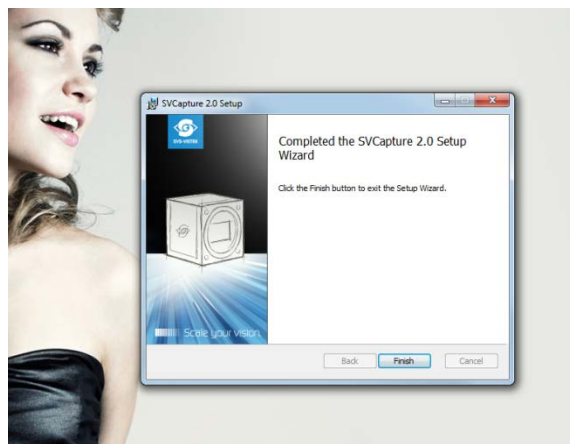

Initialization

FIRST LAUNCH

The software is XML based. So in case there is no Camera connected to the USB slot, no XML camera properties can be loaded, no values to control are available.

The screen will be empty.

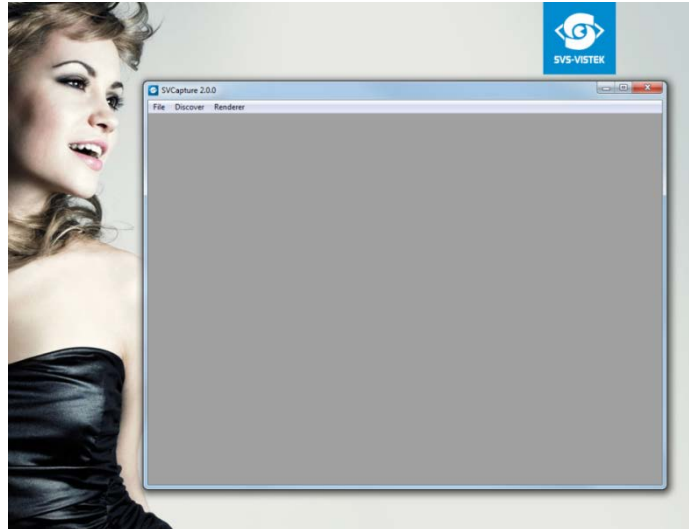

Connect the camera to your USB 3.0 slot.

Hardware installation will pop up.

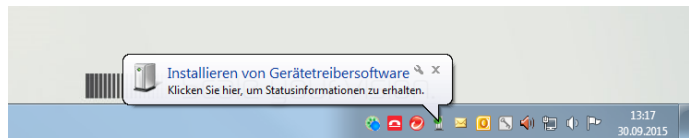

Discover the camera with SVCapture 2.x by clicking "discover".

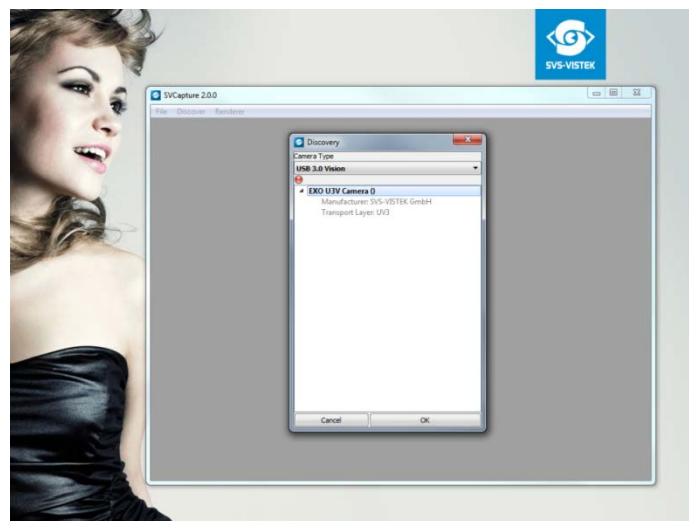

Connected cameras will be listed.

Choose your camera.

Conform to GenICam all control features will be listed in a flat tree diagram.

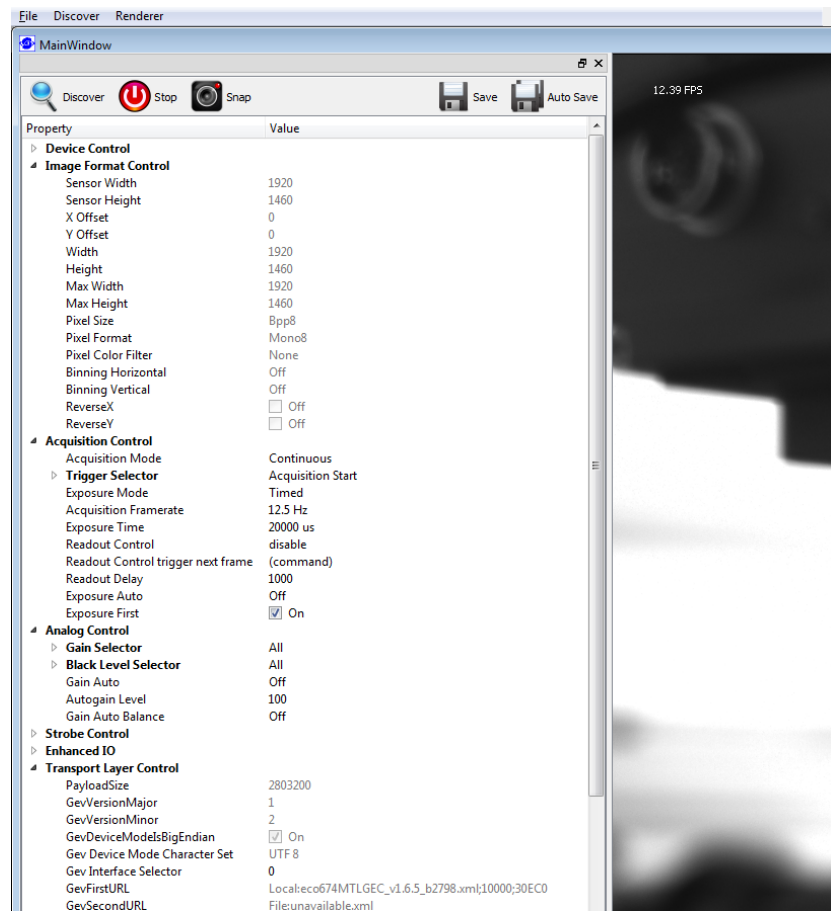

USB 3.0 driver

The USB 3.0 driver

You can find the USB 3.0 driver within your hardware manager:

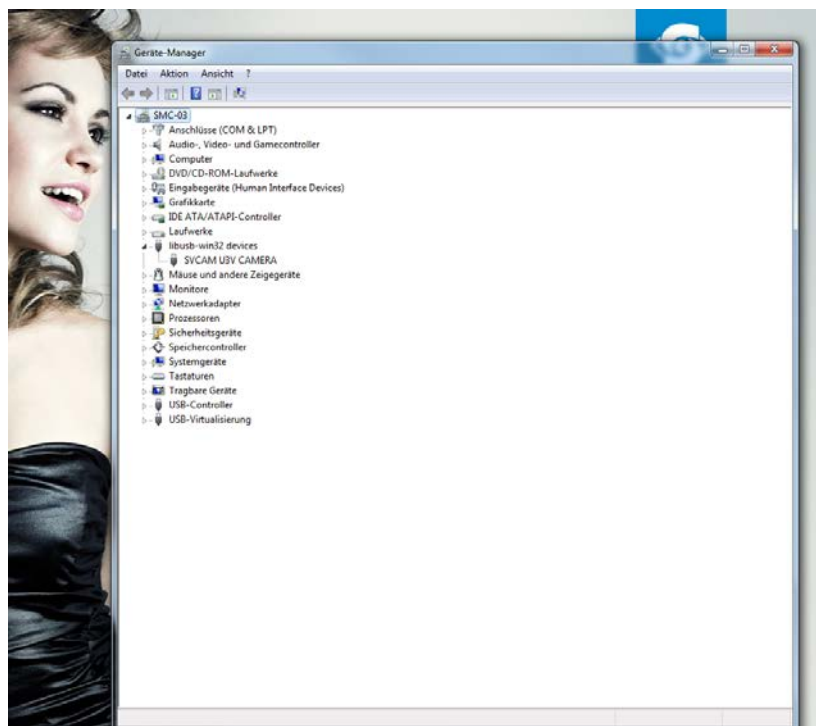

Firmware update

From time to time make sure your camera is running up to date firmware.

A firmware update tool is integrated in the software.

Internet connection needed.

In case there is no connection contact your local support:

4.4 Driver Circuit Schematics

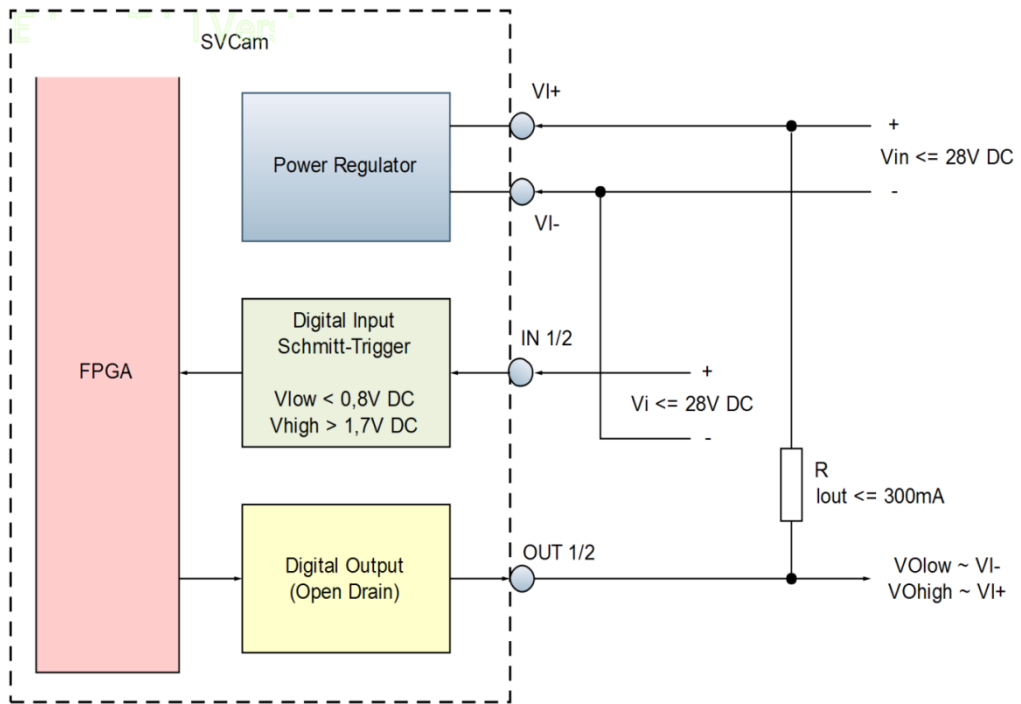

Figure 4: basic Illustration of driver circuit

5 Connectors

5.1 USB3 Vision



The USB3 Vision interface is based on the standard USB 3.0 interface and uses USB 3.0 ports.

If you drive the camera as a light controller (see chapter 410) depending on the current the light is pulling it might be necessary to power the camera with an external power supply as standard USB3 devices are limited in their current supply.

5.2 Input / output connectors

For further information using the **breakout box** and simplifying I/O connection refer to **SVCam Sensor Actor** manual (with Murr and Phoenix breakout boxes). To be found separate within the USP manuals.



Hirose™ 12Pin

For detailed information about switching lights from inside the camera, refer to strobe control.

Specification

Type	HR10A-10R-12S
Mating Connector	HR10A-10R-12P

Hirose 12 Pin

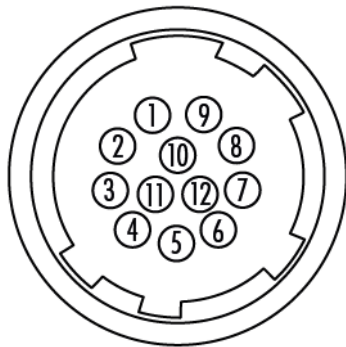

1	VIN –	(GND)
2	VIN +	(10V to 25V DC)
3	IN4	(RXD RS232)
4	OUT4	(TXD RS232)
5	IN1	(0-24V)
6	IN2	(0-24V)
7	OUT1	(open drain)
8	OUT2	(open drain)
9	IN3 +	(opto In +)
10	IN3 –	(opto In –)
11	OUT3	(open drain)
12	OUT0	(open drain)

Figure 5: Illustration of Hirose 12 Pin & pin-out (HR10A-10R-12PB)

6 Dimensions

All length units in mm. CAD step files available on DVD or SVS-VISTEK.com

6.1 exo694*U3, exo814*U3, exo834*U3

front

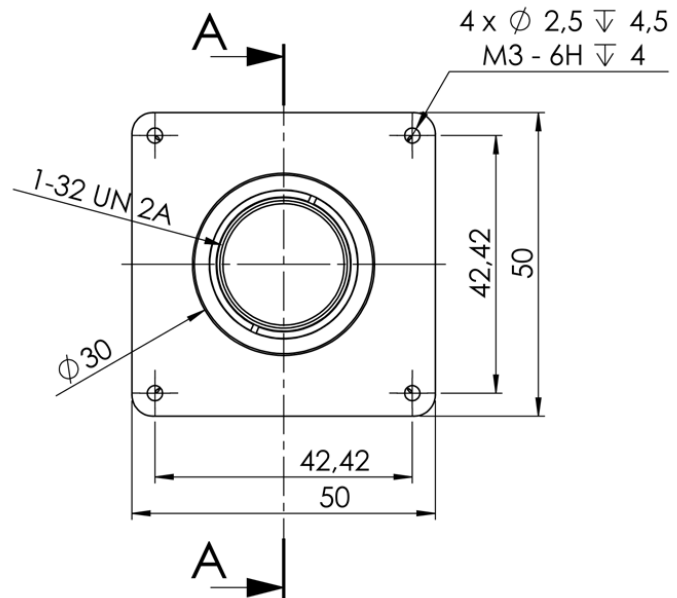

side Left

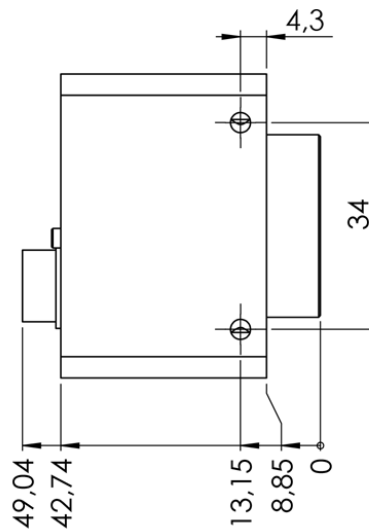

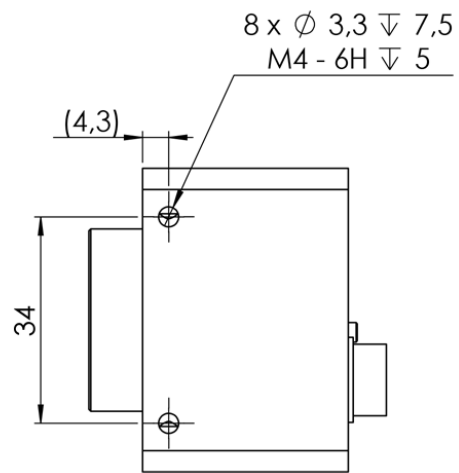
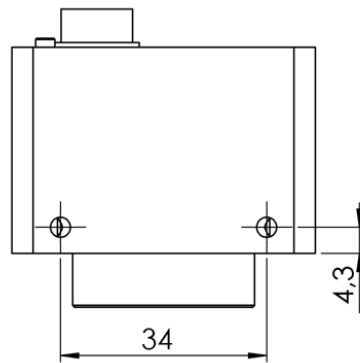
Side Right**Top**

Bottom

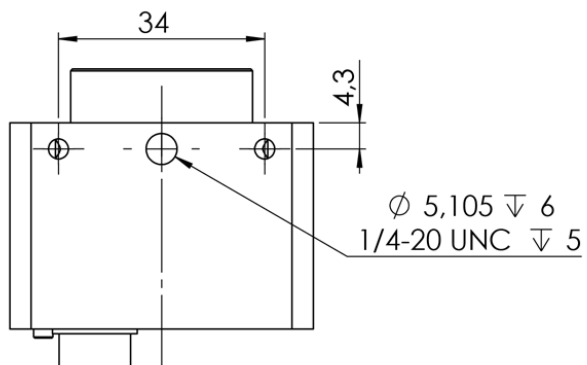

Back

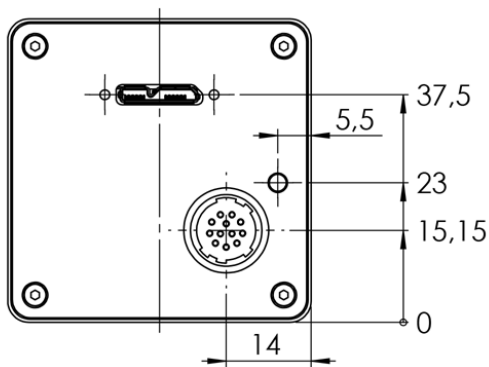

Cross Section

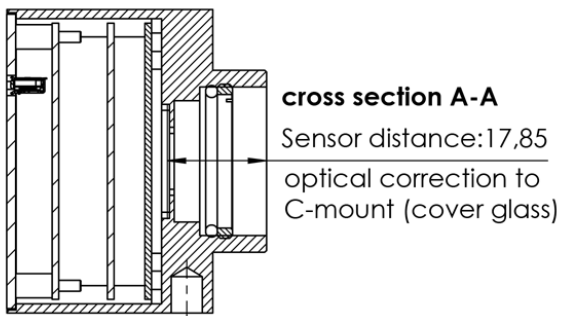

6.2 C & CS Mount

Different back-focus distances from sensor to lens.

- > C-Mount: 17,526 mm
- > CS-Mount: 12,526 mm
- > Diameter: 1 Inch
- > Screw Thread: 1/32 Inch

CS-Mount Cameras accept both types of lenses. C-Mount lenses require a 5mm adapter ring to be fitted. (Also available at SVS-VISTEK)

C-Mount Cameras only accept C mount lenses as the flange to sensor distance does not allow a CS mount lens close enough to the Sensor to achieve a focused image.

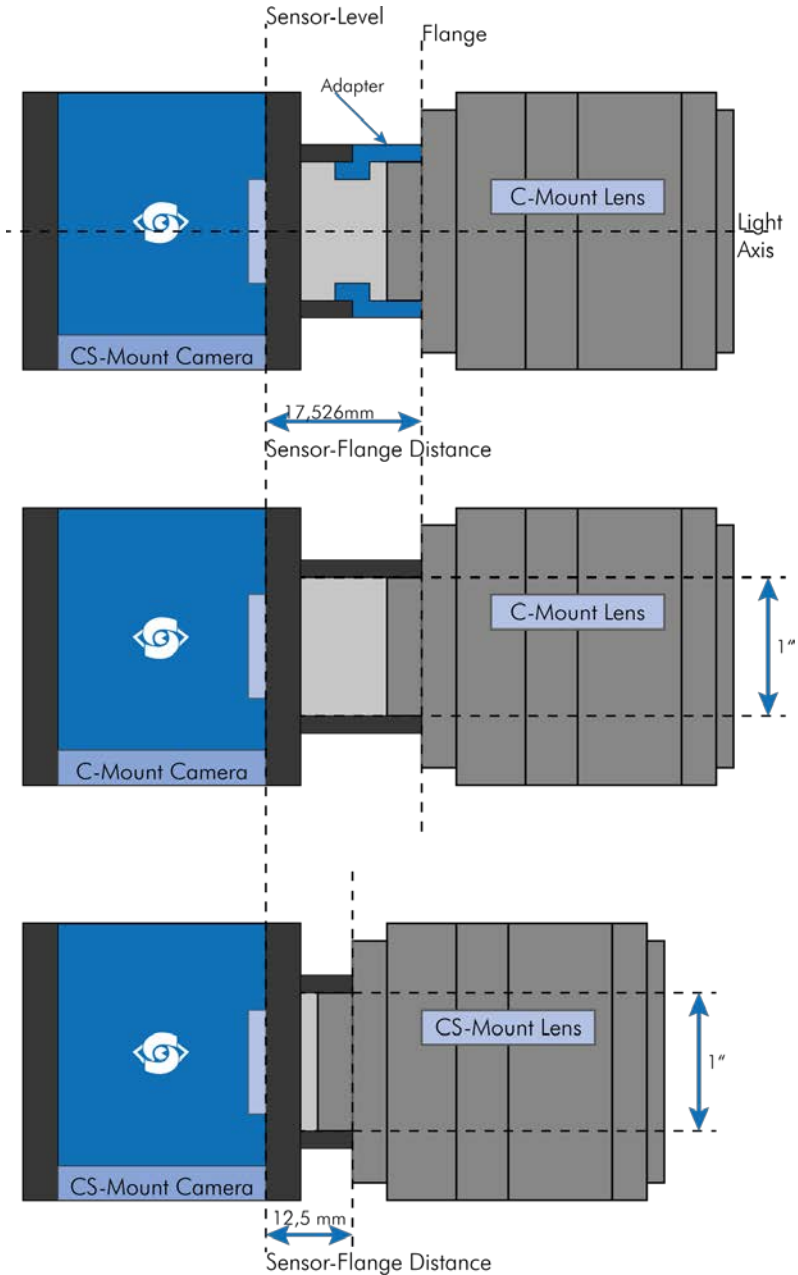

Figure 6: Illustration of C- & CS-Mount differences

7 Feature-Set

7.1 Basic Understanding

7.1.1 Basic Understanding of CCD Technology

CCD is the abbreviation for Charge Coupled Device.

In an area device light sensitive semiconductor elements are arranged in rows and columns. Each row in the array represents a single line in the resulting image. When light falls onto the sensor elements, photons are converted into electrons, creating a proportional light input signal.

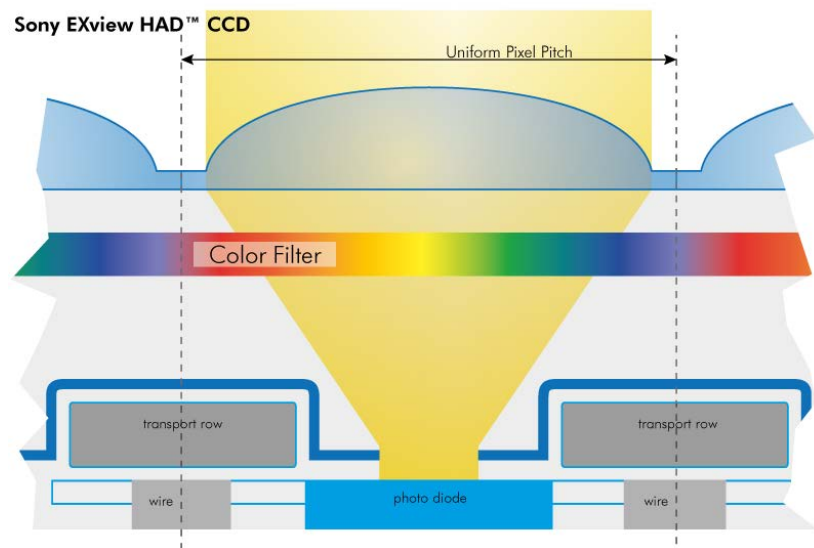
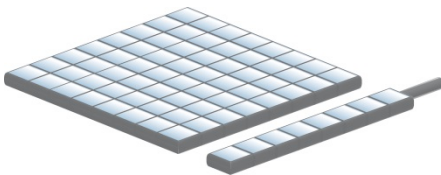

Figure 7: Illustration Cross-section of a CCD sensor from Sony



Charge is an integration of time and light intensity on the element. Like this the image gets brighter the longer the CCD cell is exposed to light.

The sensor converts light into charge and transports it to an amplifier and subsequently to the analog to digital converter (ADC).

7.1.2 Interline Transfer

Interline Transfer is only used in CCD sensors.

With a single pixel clock the charge from each pixel is transferred to the vertical shift register. At this time, the light sensitive elements are again collecting light. The charge in the vertical registers is transferred line by line into the horizontal shift register. Between each (downward) transfer of the vertical register, the horizontal register transfers each line the output stage, where charge is converted to a voltage, amplified and sent on to the ADC. When all lines in the image have been transferred to the horizontal register and read out, the vertical registers can accept the next image...

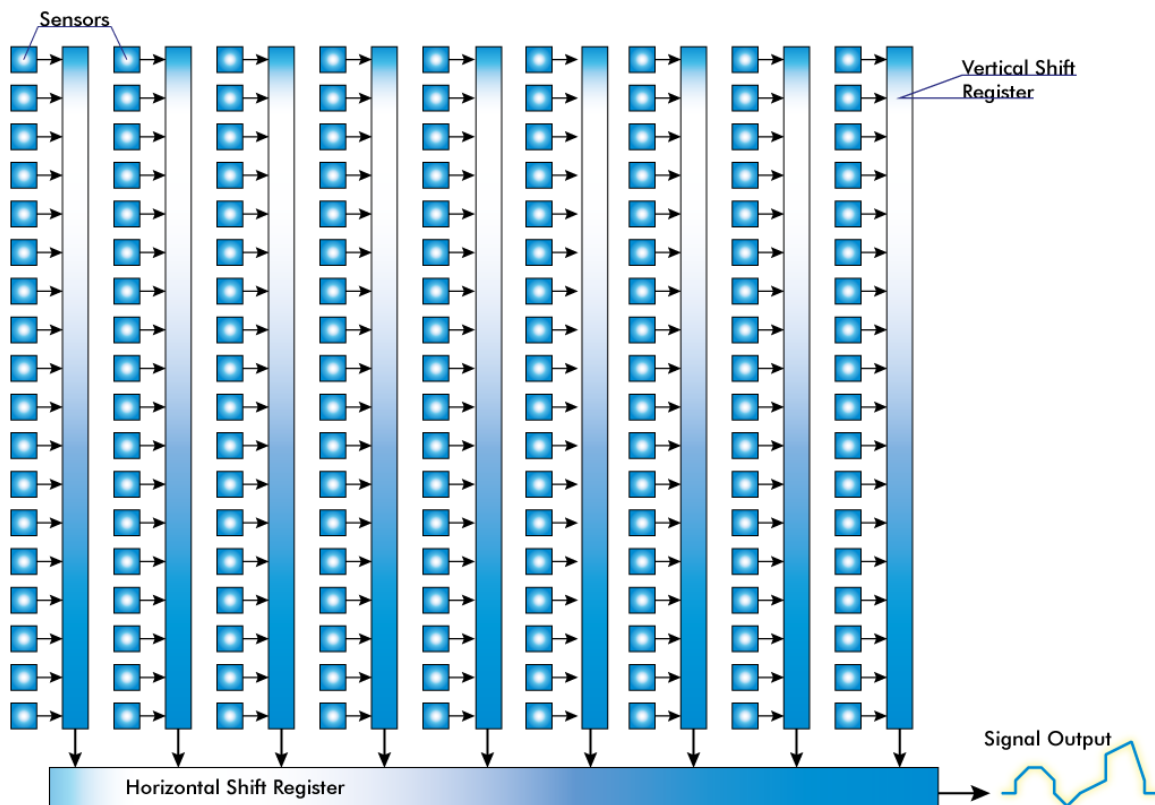

Figure 8: Illustration of interline transfer with columns and rows



Figure 9: Rolling shutter with fast moving object details

7.1.3 Global Shutter / Progressive Scan

Unlike rolling shutter or interlaced scan modes all pixels are exposed at the same time. Fast moving objects will be captured without showing movement distortion.



Figure 10: motion blur



Figure 11 rolling shutter with moving objects



Figure 12: interlaced effect

7.1.4 Frames per Second

Frames per second, or frame rate describes the number of frames output per second. The inverse ($1 / \text{frame rate}$) defines the frame time.

frame per second	frame time (Exposure)	applicable standard
0,25	4 s	
1	1 s	
2	500ms	
20	50 ms	
24	41,6 ms	Cinema
25	40 ms	PAL progressive
29,97	33,366700033... ms	NTSC
30	33,33 ms	NTSC
50	20 ms	PAL interlaced
75	13,33 ms	
100	10 ms	

Virtually any value within the specification can be chosen.

Maximum frame rate depends on:

- > Pixel clock
- > Image size
- > Tap structure
- > Data transport limitation
- > Processing time

7.1.5 Acquisition and Processing Time

The whole period of time a picture is exposed, transferred and processed can differ and takes longer.

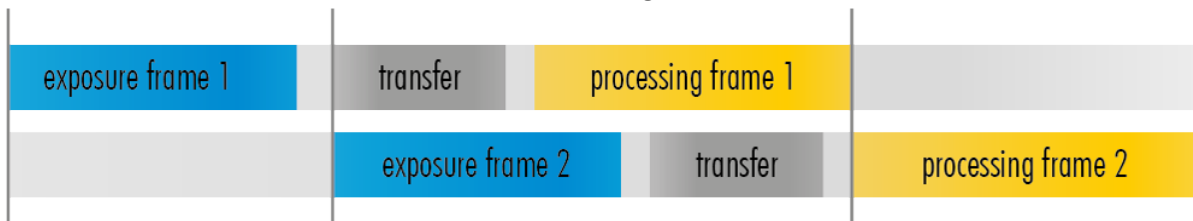

7.1.6 Exposure

See various exposure and timing modes in chapter: [Basic capture modes](#).

Combine various exposure timings with PWM LED illumination, refer to [sequencer](#).

Setting Exposure time

Exposure time can be set by width of the external or internal triggers or programmed by a given value.

7.1.7 Auto Luminance

Auto Luminance automatically calculates and adjusts exposure time and gain, frame-by-frame.

The auto exposure or automatic luminance control of the camera signal is a combination of an automatic adjustment of the camera exposure time (electronic shutter) and the gain.

The first priority is to adjust the exposure time and if the exposure time range is not sufficient, gain adjustment is applied. It is possibility to pre-define the range (min. / max. -values) of exposure time and of gain.

The condition to use this function is to set a targeted averaged brightness of the camera image. The algorithm computes a gain and exposure for each image to reach this target brightness in the next image (control loop). Enabling this functionality uses always both – gain and exposure time.

Limitation

As this feature is based on a control loop, the result is only useful in an averaged, continuous stream of images. Strong variations in brightness from one image to next image will result in a swing of the control loop. Therefore it is not recommended to use the auto-luminance function in such cases.

7.1.8 Bit-Depth

Values of brightness are internally represented by numbers. Numbers are represented by bytes, consisting out of single bits. The number of bits for brightness representation is limiting the number of brightness values or colour values that can be represented. Bit depth defines how many unique colors or grey levels are available in an image after digitization. The number of bits used to quantify limits the number of levels to be used.

e.g.: 4 bits limits the quantification levels to $2^4 = 16$.

Each pixel can represent 16 grey levels

8 bits	to	2^8	=	256 values per pixel
12 bits	to	2^{12}	=	4096 values per pixel
16 bit	to	2^{16}	=	65536 values per pixel

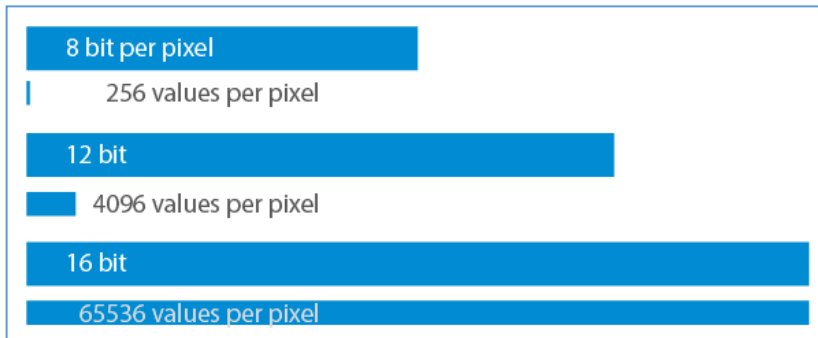

Figure 13: illustration of rising amount of values/gray scales by increasing the bit format

Every additional bit doubles the number for quantification.

SVCam output is 8, 12 or 16 bit, depending on your camera model and the way you read the values from the camera.

Be aware that increasing the bit format from 8 to 12 bit also increases the total amount of data. According to the interface framerates can be limited with higher bit

depth values.

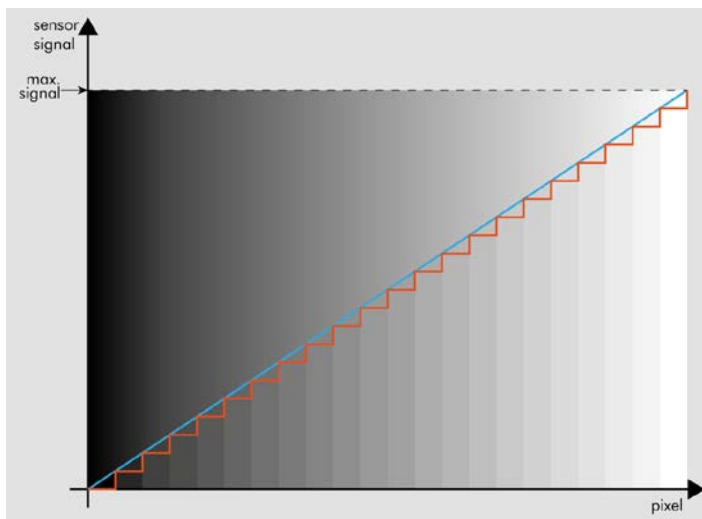

Figure 14: Simplified illustration of a quantification graph screen or in print.

As SVCam's export pure RAW-format only, color will be created on the host computer in accordance with the known Bayer-pattern by computing the brightness values into colour values..



Figure 15: illustration of shade difference in 8 bit format

As shown in figure 16 differences in shades of gray are hardly visible on



Figure 17: Figure of original picture - black & white



Figure 18: Figure of quantification with 6 shades of gray (reduced colour depth)

7.1.9 Color

Color cameras are identical to the monochrome versions. The color pixels are transferred in sequence from the camera, in the same manner as the monochrome, but considered as "raw"-format.

The camera sensor has a color mosaic filter called "Bayer" filter pattern named after the person who invented it. The pattern alternates as follows:

E.g.: First line: GRGRGR... and so on. (R=red, B=blue, G=green)
Second line: BGBGBG... and so on. Please note that about half of the pixels are green, a quarter red and a quarter blue. This is due to the maximum sensitivity of the human eye at about 550 nm (green).

Using color information from the neighboring pixels the RG and B values of each pixel is interpolated by software. E.g. the red pixel does not have information of green and blue components. The performance of the image depends on the software used.

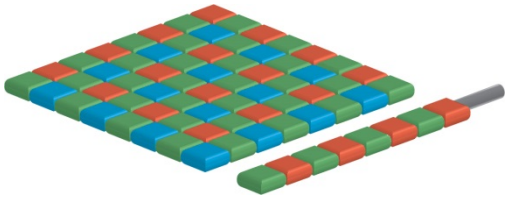

Figure 19: CCD with Bayer Pattern



NOTICE

It is recommended to use a IR cut filter for color applications!

White Balance

The human eye adapts to the definition of white depending on the lighting conditions. The human brain will define a surface as white, e.g. a sheet of paper, even when it is illuminated with a bluish light.

White balance of a camera does the same. It defines white or removes influences of a color tint in the image.

Influences normally depend on the light source used. These tints are measured in Kelvin (K) to indicate the color temperature of the illumination.

Light sources and their typical temperatures:

	Temperature	Common Light Source
	10.000 – 15.000 K	Clear Blue Sky
	6.500 – 8.000 K	Cloudy Sky / Shade
	5.500 – 6500 K	Noon Sunlight
	5.000 – 5.500 K	Average Daylight
	4.000 – 5.000 K	Electronic Flash
	4.000 – 5.000 K	Fluorescent Light
	3.000 – 4.000 K	Early AM / Late PM
	2.500 – 3.000 K	Domestic Lightning
	1.000 – 2.000 K	Candle Flame

Figure 20: Table of color temperatures

7.1.10 Resolution – active & effective

As mentions in the specifications, there is a difference between the active and the effective resolution of almost every sensor. Some pixels towards the borders of the sensor will be used only to calibrate the sensor values.

These pixels are totally darkened. The amount of dark current in these areas is used to adjust the [offset](#).

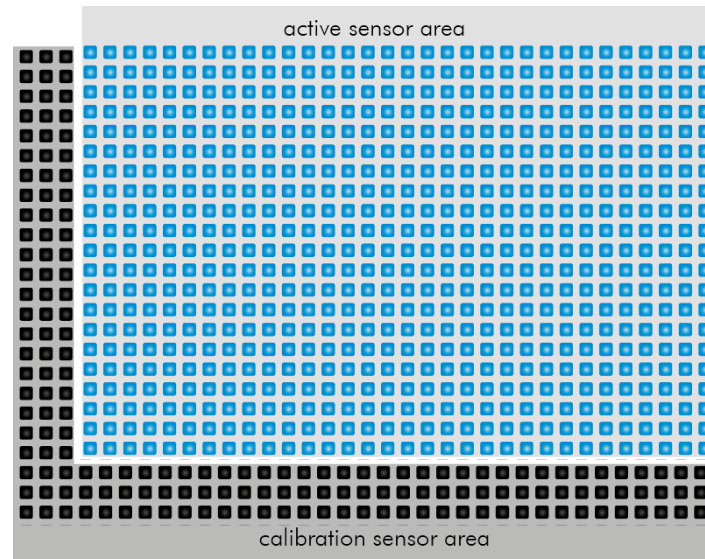

Figure 21: Illustration of active and effective sensor pixels

7.1.11 Offset

For physical reasons the output of a sensor will never be zero, even the camera is placed in total darkness or simply closed. Always there will be noise or randomly appearing electrons that will be detected as a signal.

To avoid this noise to be interpreted as a valuable signal, an offset will be set.

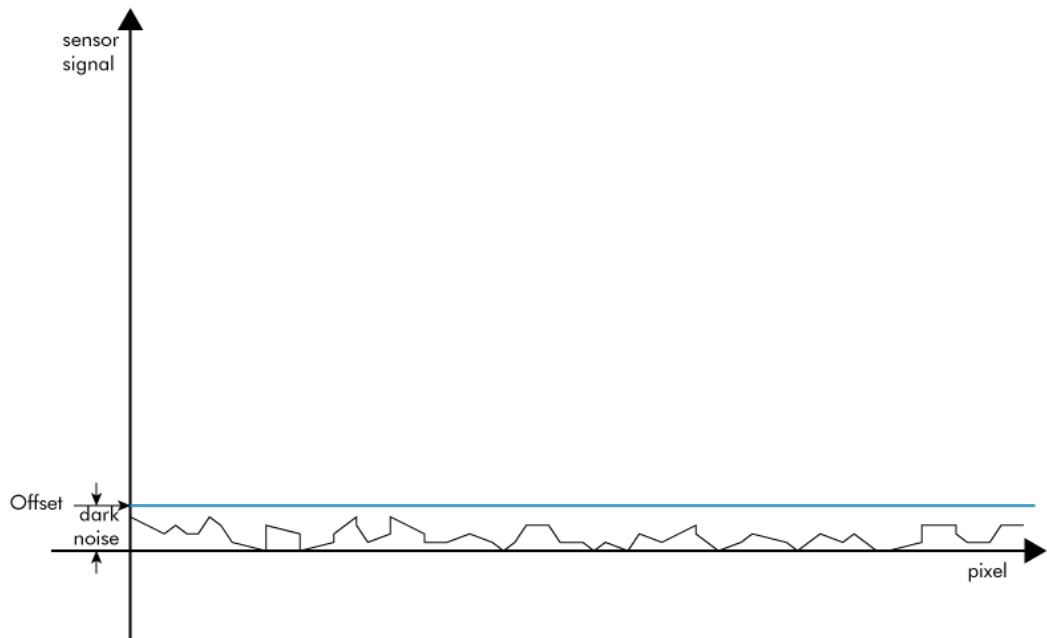

Figure 22: Illustration of dark noise cut off by the offset

Most noise is proportional to temperature. To spare you regulating the offset every time the temperature changes. A precedent offset is set by the camera itself. It references certain pixels that never were exposed to light as black (refer to [“resolution – active and effective”](#)). So the offset will be set dynamically and conditioned to external influences.

The offset can be limited by a maximum bit value. If higher values are needed, try to set a look up table.

In case of multi-tap CCD sensors:

Offset can be altered for each tap separately. Refer to [“tap balancing”](#).

7.1.12 Gain

Setting gain above 0 dB (default) is another way to boost the signal coming from the sensor. Especially useful for low light conditions.

Setting Gain amplifies the signal of individual or binned pixels before the ADC.

Referring to Photography adding gain corresponds to increasing ISO.

add 6 dB	double ISO value
6 dB	400 ISO
12 dB	800 ISO
18 dB	1600 ISO
24 dB	3200 ISO

Figure 23: Table of dB and corresponding ISO



NOTICE

Gain also amplifies the sensor's noise. Therefore, gain should be last choice for increasing image brightness. Modifying gain will not change the camera's dynamic range.

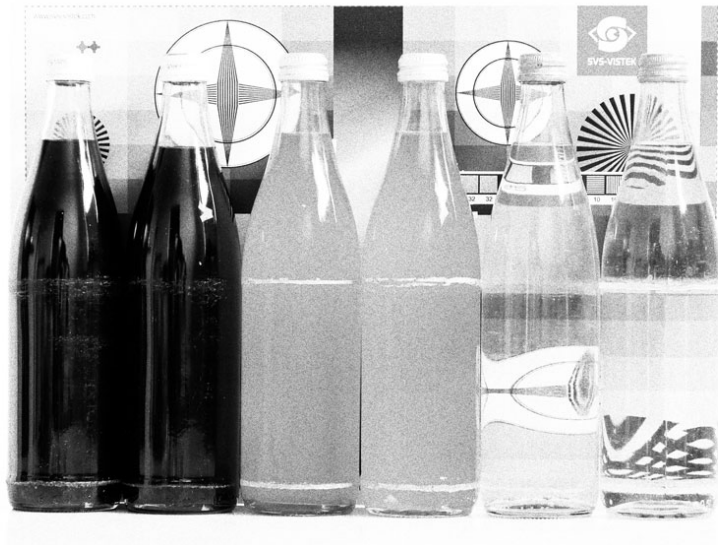

Figure 24: noise caused by increasing gain excessively

Auto Gain

For automatically adjusting Gain please refer to [Auto Luminance](#).

7.1.13 Image Flip

Images can be mirrored horizontally or vertically. Image flip is done inside the memory of the camera, therefore not increasing the CPU load of the PC.



Figure 25: Figure of original image



Figure 26: Figure of image horizontally flipped



Figure 27: Figure of image vertically flipped

7.1.14 Binning

Binning provides a way to enhance dynamic range, but at the cost of lower resolution. Instead of reading out each individual pixel, binning combines charge from neighboring pixels directly on the chip, before readout.

Binning is only used with monochrome CCD Sensors. For reducing resolution on color sensors refer to [decimation](#).

Vertical Binning

Accumulates vertical pixels.

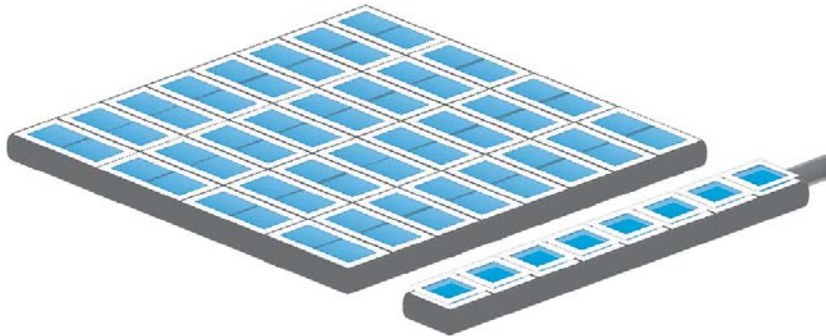

Figure 28: Illustration of vertical binning

Horizontal Binning

Accumulates horizontal pixels.

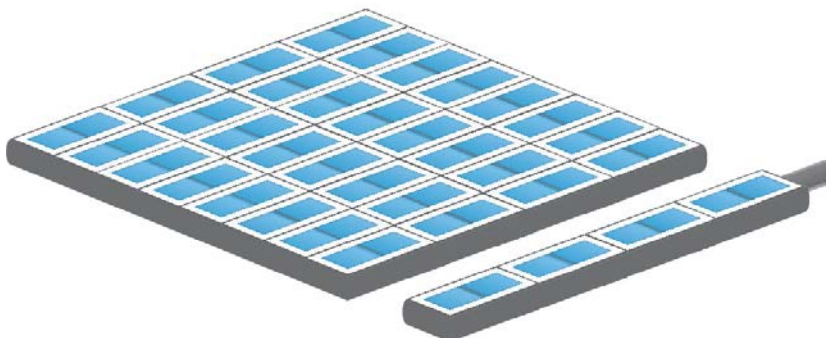

Figure 29: Illustration of horizontal binning

2x2 Binning

A combination of horizontal and vertical binning.

When DVAL signal is enabled only every third pixel in horizontal direction is grabbed.

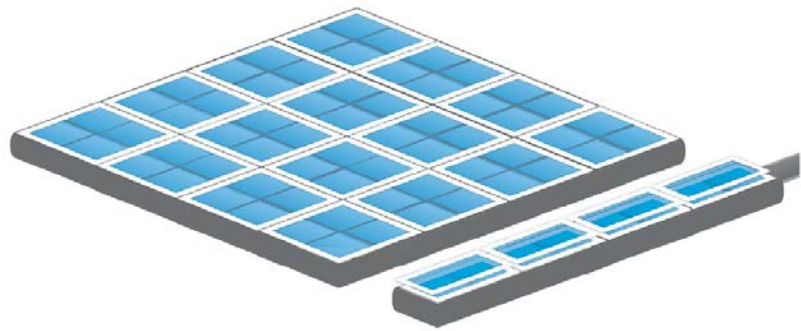

Figure 30: Illustration of 2x2 binning

7.1.15 Decimation

For reducing width or height of an image, decimation can be used. Columns or rows can be ignored.

Refer to AOI for reducing data rate by reducing the region you are interested in.



Figure 31 Horizontal decimation Figure 32 Vertical decimation

Decimation on Color Sensors

The Bayer pattern color information is preserved with 1/3 horizontal and vertical resolution. The frame readout speed increases approx. by factor 2.5.

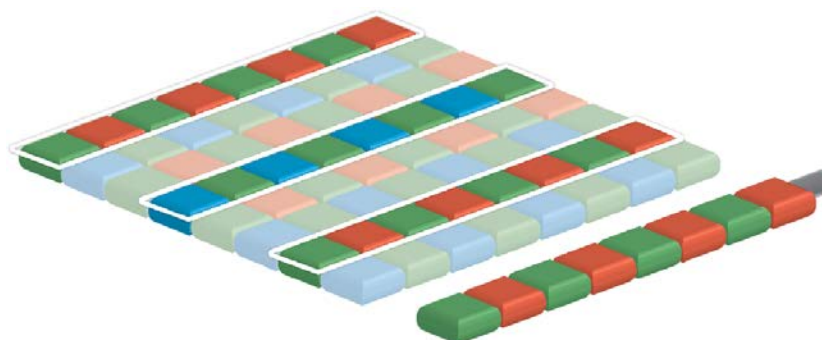

Figure 33: Illustration of decimation on color sensors

7.1.16 Burst Mode

The hardware interface (GigE, USB3 etc) of your camera very often will limit the maximum framerate of the camera to the maximum framerate of

the interface of the camera. Inside the camera, the sensor speed (internal framerate) might be higher than the external interface's speed (e.g. GigE).

In triggered mode though, trigger frequency might be higher than the external interface's speed. The triggered images will stay in the internal memory buffer and will be delivered one after the other with interface speed. If trigger frequency is higher than interface max fps frequency, more and more images will stick in the internal image buffer. As soon as the buffer is filled up, frames will be dropped.

This internal-save-images and deliver-later thing is called Burst Mode.

Due to internal restriction in the image request process of the camera, on USB cameras the maximum sensor speed is limited to the maximum interface speed. This means the maximum trigger frequency cannot be higher than camera freerun frequency. The image buffer will protect against breaking datarates of the USB line, though.

Usage of Burst Mode

Burst Mode has 2 main purposes:

- > If transfer speed breaks down (e.g. Ethernet transfer rate due to high network load), tolerate low speed transfer for a short time and deliver frames later on (buffering low speed interface performance for a short time)
- > For several frames (up to full internal memory) images can be taken with higher frame rate than camera specs are suggesting (as soon as there is enough time later on to deliver the images) (not applicable to USB cameras)

Please note, as soon as the internal memory buffer is filled up, frames will be dropped. Due to this reason, SVS-Vistek camers provide up to 512MB image buffer memory.

7.2 Camera Features

7.2.1 Standard Tap Geometries

Similar to other sensor readout technologies Camera Link is sending many pixel values in parallel at the same time. The image can be split in “taps” or “channels” which can be sent in parallel. The tap geometry is describing how many taps are read and how they are transmitted through the Camera Link interface.

Table 2: recommende tap configuration for HR25 and SHR47

Camera	Tap config	Tap geometry	Maximum speed	CL type
HR25	8T8	1X8_1Y	25	Full
	10T8	1X10_1Y	31	Deca
SHR47	2T8	1X2_1Y	3,5	Base
	4T8	1X2_2YE	7	Medium
	4T12	1X2_2YE	7	Medium

7.2.2 Tap Structure

Your camera may be equipped with a two, four or even higher taped sensor.

Tap configuration

For information according to your sensor refer to [specifications](#).

Camera output format	Tap geometry
1X-1Y	Single tap
1X-2YE	Dual tap
2X-1Y	Dual tap
2X-2YE	Four tap

Figure 34: table of tap geometry/configurations

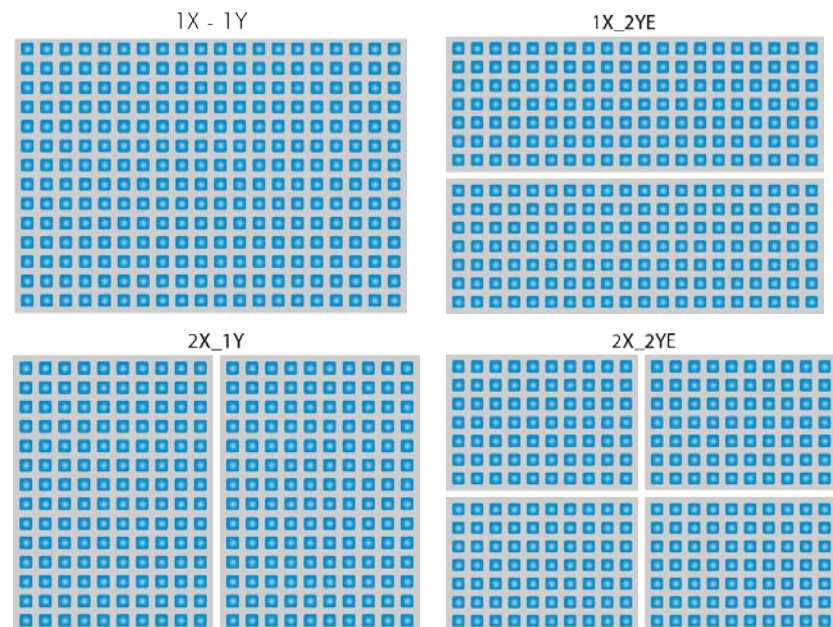

Figure 35: Illustrations of the nomenclature used in [specifications](#)

Single-Tap

In a single-tap CCD sensor the readout of pixel charge is done sequentially. Pixel by pixel, line by line. The maximum frame rate is determined by the pixel clock frequency and the total number of pixels to be read out.

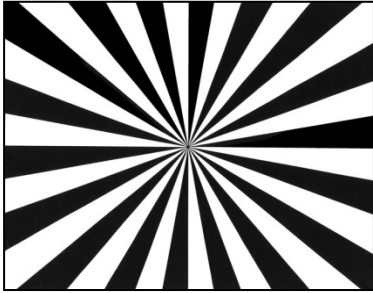

Figure 36: Figure of 1 Tap

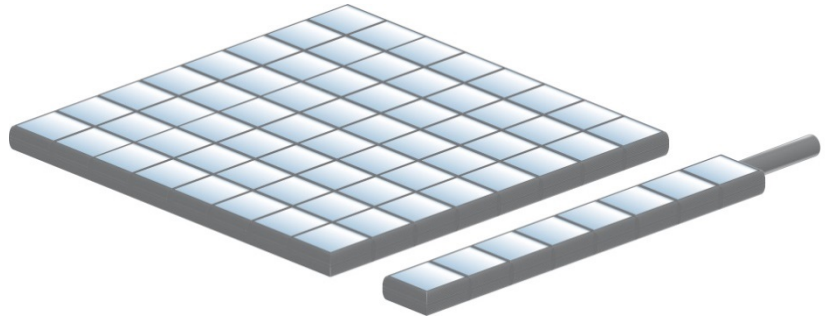

Figure 37: Illustration of 1 tap

Dual-Tap

In a dual-tap CCDs, (CCD with two outputs) the readout of pixel charge takes place in a serial/parallel sequence. Each line is divided in half and the pixels of both halves are read out simultaneously, line by line. For a given pixel clock frequency, only half the time is required to read out the entire array, resulting in twice the framerate.

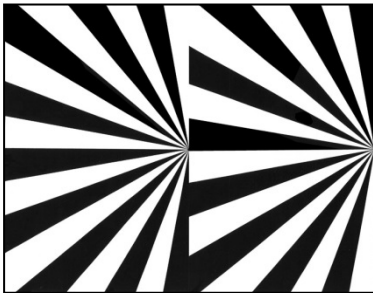

Figure 38: Figure of 2 taps

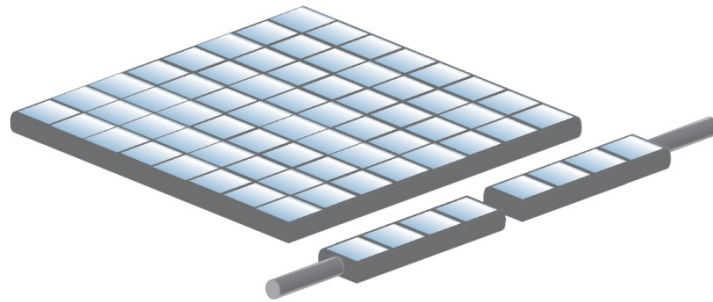

Figure 39: Illustration of 2 taps

1.1.1.1 Tap Reconstruction on USB3 Vision

Tap reconstruction takes place within the Camera in order to display the image correctly. Further balancing still can be done after reconstruction.

7.2.3 Tap Balancing

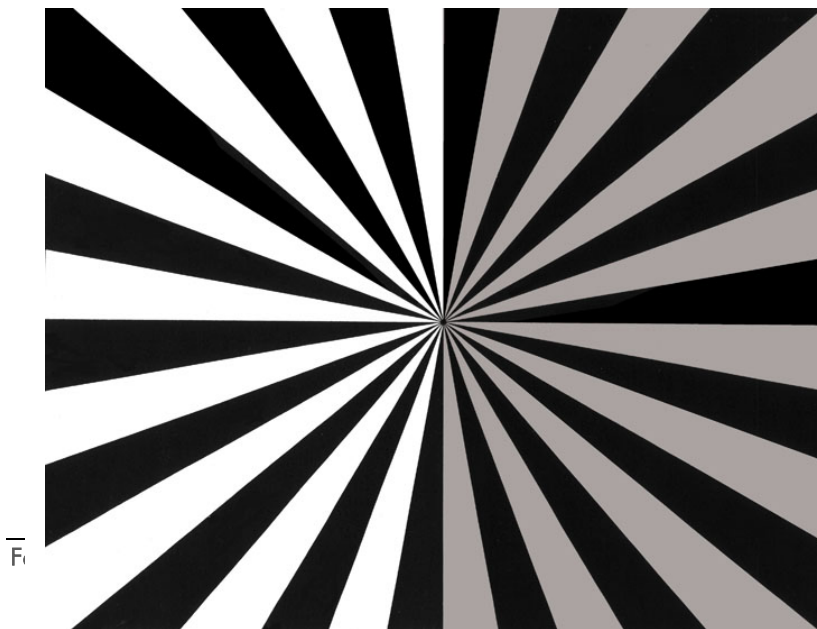

Figure 40: Figure of an unbalanced 2 tap image

In sensors with multiple the tap structure, parts of the picture may appear differently. Taps may display difference in dynamics and brightness.

To eliminate these differences, tap balancing offers gain adjustments separately for each tap.

This is due to the requirement for a dual or quad -ADC circuit to handle the simultaneous digitization of the two or more channels of analog signal

coming from the CCD. The fact that the separate analog output channels not being perfectly linear and the separate output amplifiers having physically different slopes leads to the necessity to sometimes manually or automatically adjust the gain levels of each channel independently to obtain a homogenous image.

Automatic Tap Balancing

Automatic Tap Balancing analyses a narrow strip at the border of the taps. It adjusts the gain value to the average brightness value of these strips.

7.2.3.1.1 Continuously Tap Balancing

Automatic Tap Balancing can be done continuously. Taps will be balanced from one image to the next.

7.2.3.1.2 Tap Balancing once

When performing Tap Balancing once. Only one specific image will be analyzed. The gain-correction values will be saved and applied to subsequent images.

Manual Tap Balancing

Tap Balancing can be performed manually

7.2.4 System Clock Frequency

Default system clock frequency in almost every SVCam is set to 66.6 MHz. To validate your system frequency: refer to: [specifications](#).

Using the system clock as reference of time, time settings can only be made in multiples of 15 ns.

$$t = \frac{1}{66.6 \text{ MHz}} = \frac{1}{66\,666\,666.6 \frac{1}{\text{s}}} = 15 \cdot 10^{-9} \text{ s} = 15 \text{ ns}$$



NOTICE

Use multiples of 15 ns to write durations into camera memory

7.2.5 Temperature Sensor

A temperature sensor is installed on the mainboard of the camera.

To avoid overheating, the temperature is constantly monitored and read. Besides software monitoring, the camera indicates high temperature by a red flashing LED. (See flashing LED codes)

7.2.6 Basic Capture Modes

Free Running

Free running (fixed frequency) with programmable exposure time. Frames are readout continuously and valid data is indicated by LVAL for each line and FVAL for the entire frame.

Mode 0: Free Running with Programmable Exposure Time

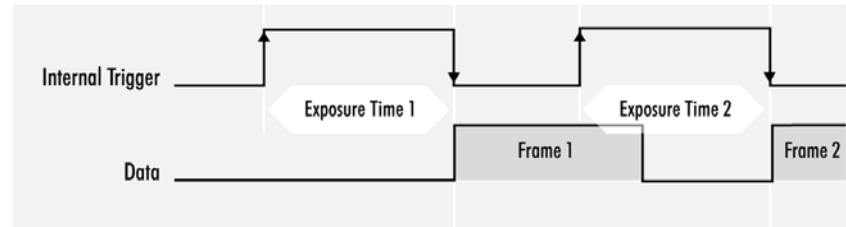

There is no need to trigger the camera in order to get data. Exposure time is programmable via serial interface and calculated by the internal logic of the camera.



NOTICE

The fundamental signals are:
Line Valid: LVAL, Frame Valid: FVAL,
And in case of triggered modes: trigger input.

Triggered Mode (pulse width)

External trigger and pulse-width controlled exposure time. In this mode the camera is waiting for an external trigger, which starts integration and readout. Exposure time can be varied using the length of the trigger pulse (rising edge starts integration time, falling edge terminates the integration time and starts frame read out). This mode is useful in applications where the light level of the scene changes during operation. Change of exposure time is possible from one frame to the next.

Mode 1: External Trigger with Pulse Width Exposure Control (overlap)

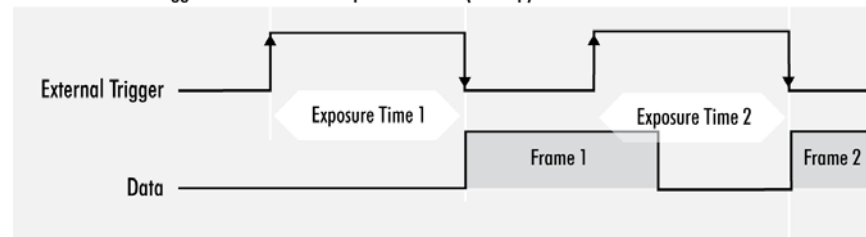

Exposure time of the next image can overlap with the frame readout of the current image (rising edge of trigger pulse occurs when FVAL is high). When this happens: the start of exposure time is synchronized to the falling edge of the LVAL signal.

Mode 1: External Trigger with Pulse Width Exposure Control (non overlap)

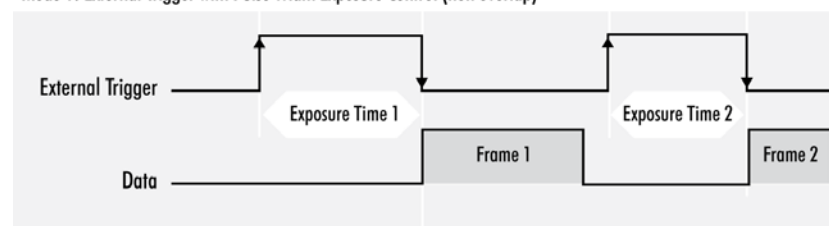

When the rising edge of trigger signal occurs after frame readout has ended (FVAL is low) the start of exposure time is not synchronized to LVAL and exposure time starts after a short and persistent delay.

The falling edge of the trigger signal must always occur after readout of the previous frame has ended (FVAL is low).

External Trigger (Exposure Time)

External trigger with programmable exposure time. In this mode the camera is waiting for an external trigger pulse that starts integration, whereas exposure time is programmable via the serial interface and calculated by the internal microcontroller of the camera.

At the rising edge of the trigger the camera will initiate the exposure.

The software provided by SVS-Vistek allows the user to set exposure time e.g. from 60 μ s 60 Sec (camera type dependent).

Exposure time of the next image can overlap with the frame readout of the current image (trigger pulse occurs when FVAL is high). When this happens, the start of exposure time is synchronized to the negative edge of the LVAL signal (see figure)

Mode 2: External Trigger with Programmable Exposure Time (overlap)

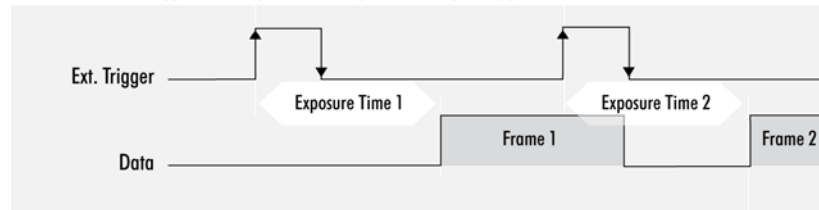

When the rising edge of trigger signal occurs after frame readout has ended (FVAL is low), the start of exposure time is not synchronized to LVAL and exposure time starts after a short and persistent delay.

Mode 2: External Trigger with Programmable Exposure Time (non overlap)

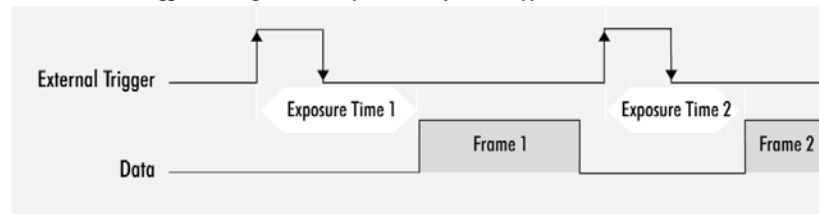

Exposure time can be changed during operation. No frame is distorted during switching time. If the configuration is saved to the EEPROM, the set exposure time will remain also when power is removed.

Detailed Info of External Trigger Mode

Diagrams below are equivalent for CCD and CMOS technique.

Mode 1: External Trigger with Pulse Width Exposure Control (non overlap)

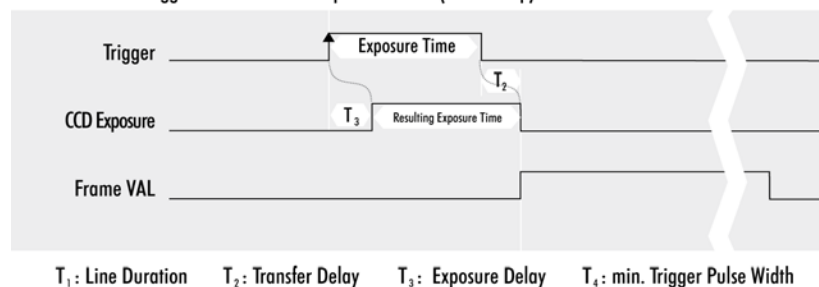

Mode 1: External Trigger with Pulse Width Exposure Control (overlap)

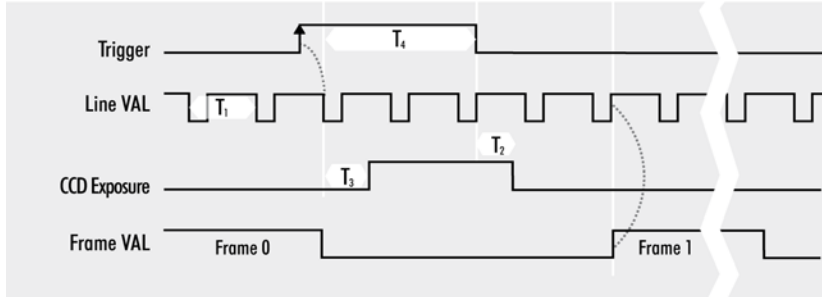

T_1 : Line Duration T_2 : Transfer Delay T_3 : Exposure Delay T_4 : min. Trigger Pulse Width

Mode 2: External Trigger with Programmable Exposure Time (non overlap)

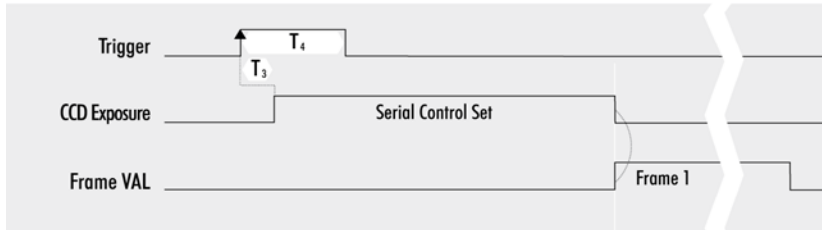

T_1 : Line Duration T_2 : Transfer Delay T_3 : Exposure Delay T_4 : min. Trigger Pulse Width

Mode 2: External Trigger with Programmable Exposure Time (overlap)

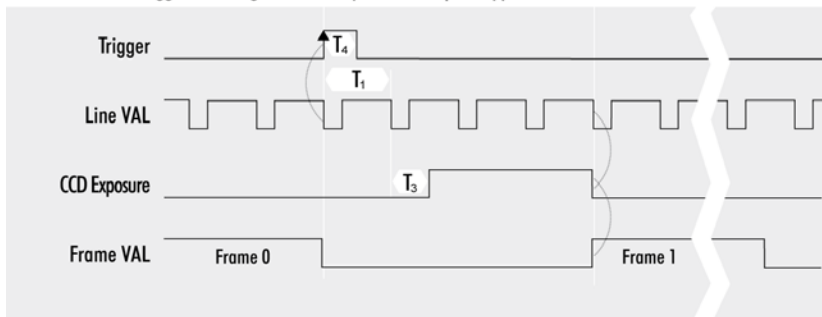

T_1 : Line Duration T_2 : Transfer Delay T_3 : Exposure Delay T_4 : min. Trigger

Software Trigger

Trigger can also be initiated by software (serial interface).



NOTICE

Software trigger can be influenced by jitter. Avoid Software trigger at time sensitive applications

7.2.7 LookUp Table

The LookUp Table Feature (LUT) lets the user define certain values to every bit value that comes from the ADC.

To visualize a LUT a curve diagram can be used, similar to the diagrams used in photo editing software.

The shown custom curve indicates a contrast increase by applying an S-shaped curve. The maximum resolution is shifted to the mid-range. Contrasts in this illumination range is increased while black values will be interpreted more black and more of the bright pixels will be displayed as 100 % white...

For further Information about curves and their impact on the image refer to our homepage: [Knowledge Base – LUT](#)

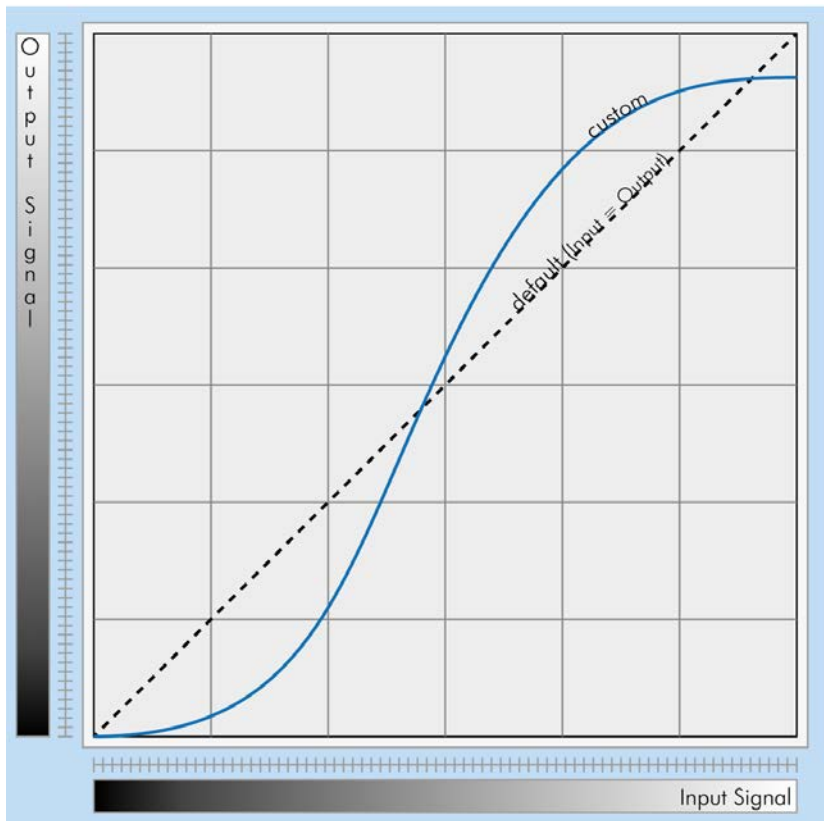

Figure 41: illustration of a custom LUT adding contrast to the midtones

i **NOTICE**
LUT implementation reduces bit depth from 12 bit to 8 bit on the output.

Gamma Correction

Using the LookUp Table makes it also possible to implement a logarithmic correction. Commonly called Gamma Correction.

Historically Gamma Correction was used to correct the illumination behavior of CRT displays, by compensating brightness-to-voltage with a Gamma value between 1,8 up to 2,55.

The Gamma algorithms for correction can simplify resolution shifting as shown seen above.

Input & Output signal range from 0 to 1

$$\text{Output-Signal} = \text{Input-Signal}^{\text{Gamma}}$$

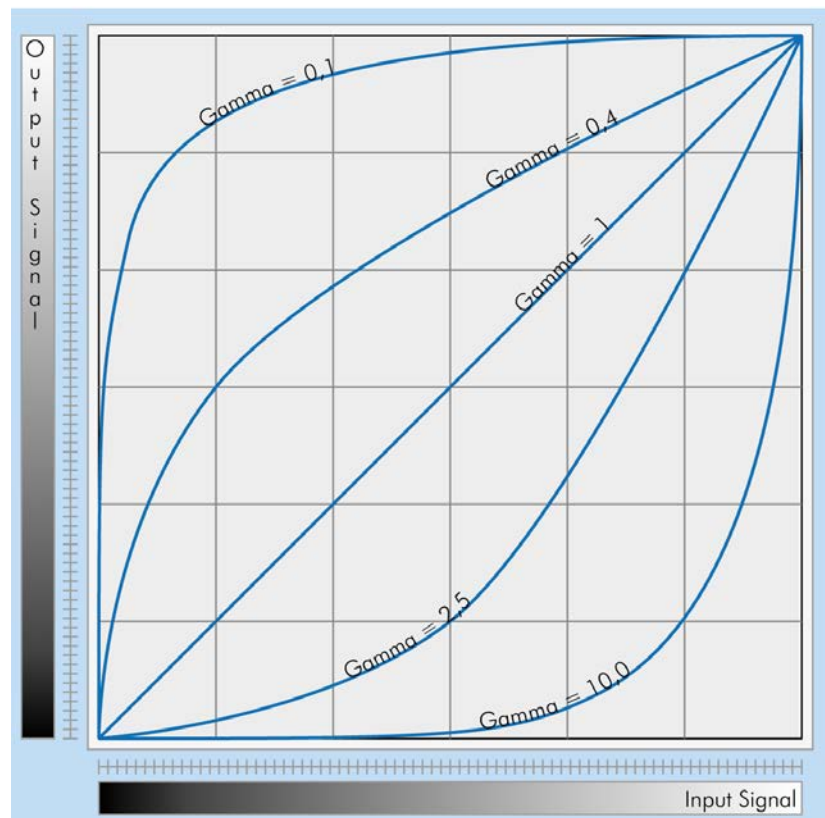

Figure 42: illustration of several gamma curves comparable to a LUT

Gamma values less than 1.0 map darker image values into a wider range.

Gamma values greater than 1.0 do the same for brighter values.



NOTICE

Gamma Algorithm is just a way to generate a LUT. It is not implemented in the camera directly..

7.2.8 ROI / AOI

In Partial Scan or Area-Of-Interest or Region-Of-Interest (ROI) -mode only a certain region will be read.

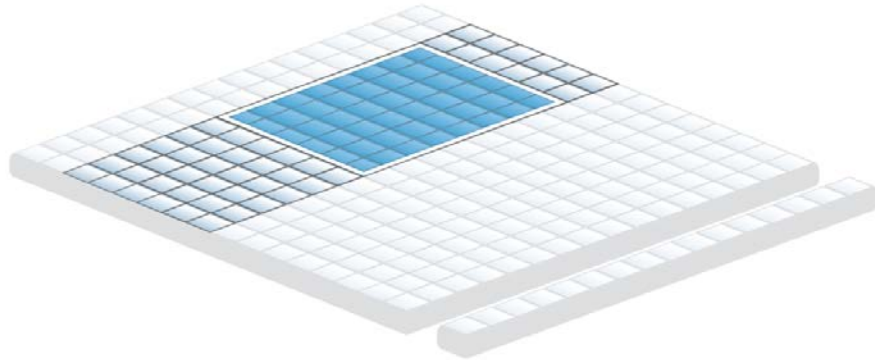

Figure 43: Illustration of AOI limitation on a CCD sensor

Selecting an AOI will reduce the number of horizontal lines being read. This will reduce the amount of data to be transferred, thus increasing the maximum speed in term of frames per second.

With CCD sensors, setting an AOI on the left or right side does not affect the frame rate, as lines must be read out completely.

7.3 I/O Features

7.3.1 Assigning I/O Lines – IOMUX

The IOMUX is best described as a switch matrix. It connects inputs, and outputs with the various functions of SVCam I/O. It also allows combining inputs with Boolean arguments.

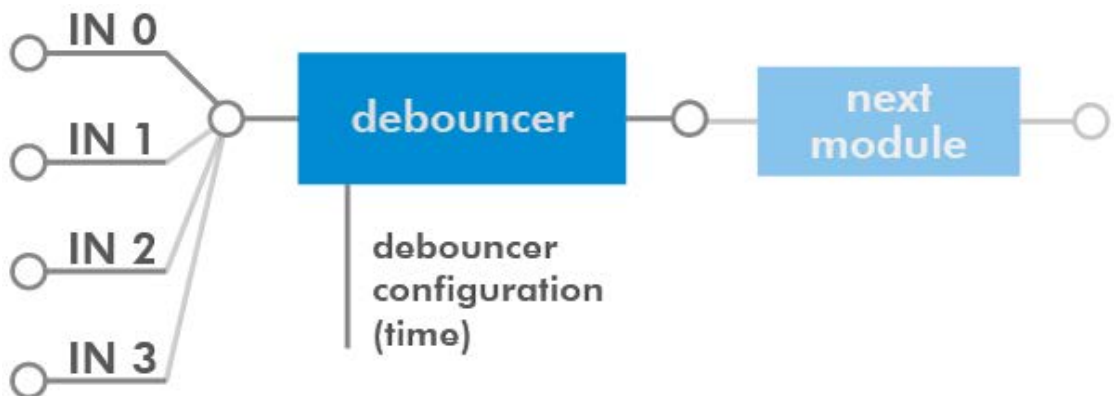

Figure 44: "IN0" connected to "debouncer"

LineSelector	translation
Line0	Output0

Line1	Output1
Line2	Output2
Line3	Output3
Line3	Output4
Line5	Uart In
Line6	Trigger
Line7	Sequencer
Line8	Debouncer
Line9	Prescaler
Line10	Input0
Line11	Input1
Line12	Input2
Line13	Input3
Line14	Input4
Line15	LogicA
Line16	LogicB
Line17	LensTXD
Line18	Pulse0
Line19	Pulse1
Line20	Pulse2
Line21	Pulse3
Line22	Uart2 In

The input and output lines for Strobe and Trigger impulses can be arbitrarily assigned to actual [data lines](#). Individual assignments can be stored persistently to the EPROM. Default setting can be restored from within the Camera.

Note:

If you connect the camera with a non-SVS-Vistek GigEVision client, you might not see the clearnames of the lines, but only line numbers. In this case, use this list of line names

Refer to pinout in [input / output connectors](#) when physically wiring.

Also the IOMUX can be illustrated as a three dimensional dice. Long address spaces indicate which signals are routed to witch module within the camera.

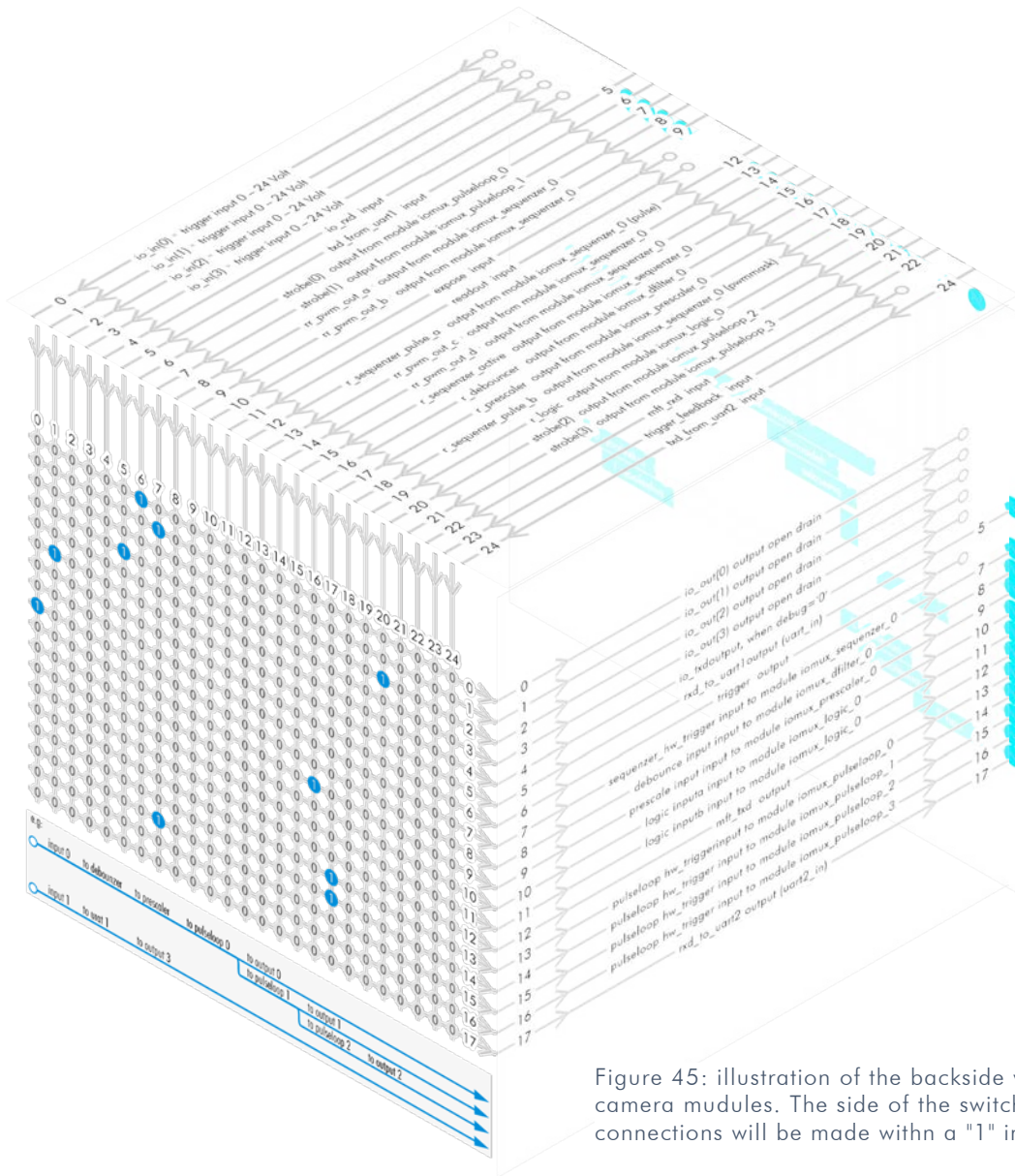
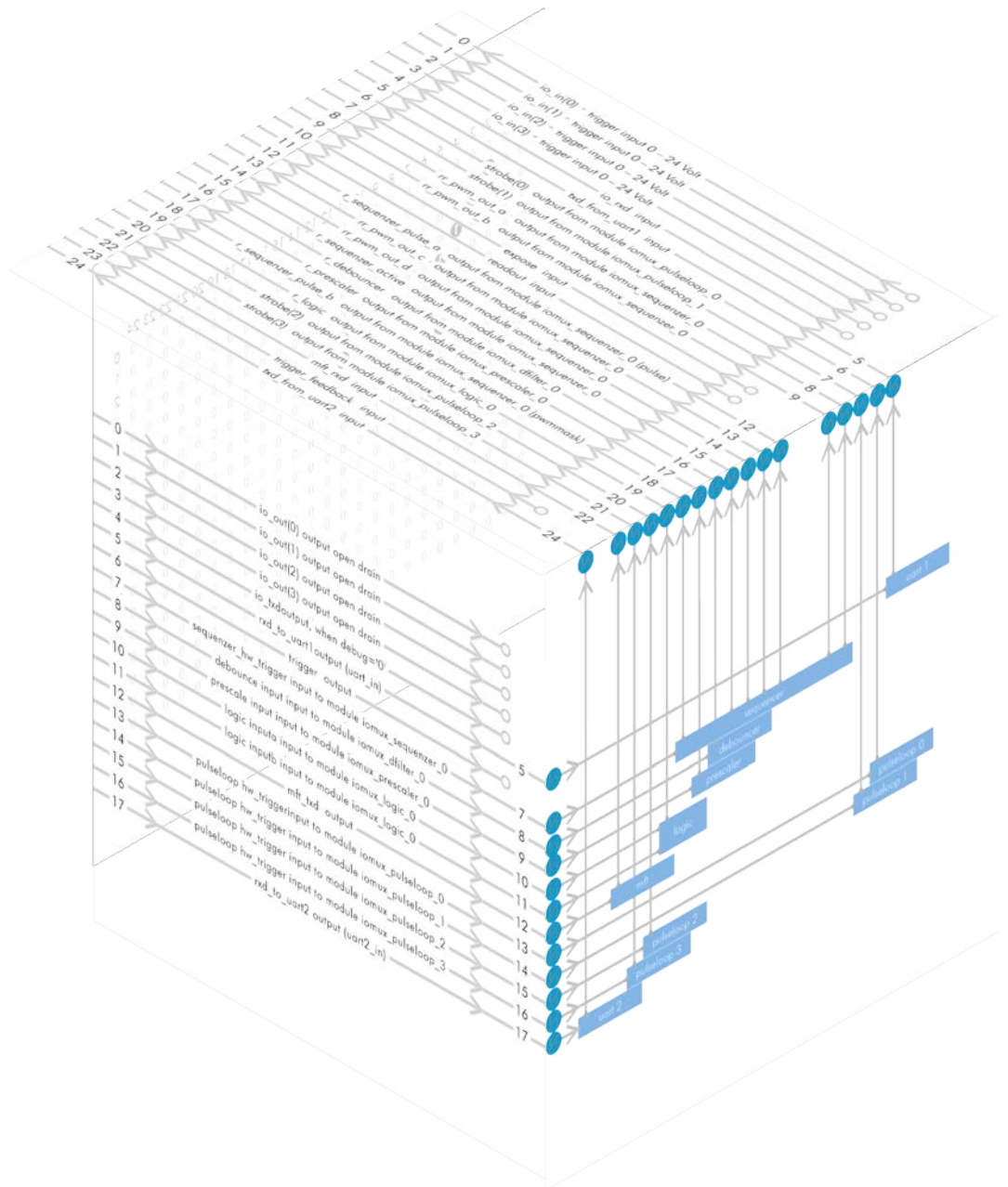

Figure 45: illustration of the backside view of the camera modules. The side of the switch matrix. connections will be made with a "1" instead of a "0"

Figure 46: illustration of frontside view to the camera modules.

Lines with open end indicate physical in- and outputs



input vector to switch matrix

nr.	name	description
0	io_in(0)	trigger input 0 – 24 Volt / RS-232 / opto *
1	io_in(1)	trigger input 0 – 24 Volt / RS-232 / opto *
2	io_in(2)	trigger input 0 – 24 Volt / RS-232 / opto *
3	io_in(3)	trigger input 0 – 24 Volt / RS-232 / opto *
4	io_rxd input	
5	txd_from_uart1	input
6	strobe(0)	output from module iomux_pulseloop_0
7	strobe(1)	output from module iomux_pulseloop_1
8	rr_pwm_out_a	output from module iomux_sequenzer_0
9	rr_pwm_out_b	output from module iomux_sequenzer_0
10	expose input	
11	readout input	
12	r_sequenzer_pulse_a	output from module iomux_sequenzer_0 (pulse)
13	rr_pwm_out_c	output from module iomux_sequenzer_0
14	rr_pwm_out_d	output from module iomux_sequenzer_0
15	r_sequenzer_active	output from module iomux_sequenzer_0
16	r_debouncer	output from module iomux_dfilter_0
17	r_prescaler	output from module iomux_prescaler_0
18	r_sequenzer_pulse_b	output from module iomux_sequenzer_0 (pwmmask)
19	r_logic	output from module iomux_logic_0
20	strobe(2)	output from module iomux_pulseloop_2
21	strobe(3)	output from module iomux_pulseloop_3
22	mft_rxd input	
23	trigger_feedback	input
24	txd_from_uart2	input

* refer to pinout or [specifications](#)

output vector from switch matrix

nr.	name / register	description
0	io_out(0)	output open drain
1	io_out(1)	output open drain
2	io_out(2)	output open drain *
3	io_out(3)	output open drain *
4	io_txd	output, when debug='0'
5	rxd_to_uart1	output (uart_in)
6	trigger	output
7	sequenzer_hw_trigger	input to module iomux_sequenzer_0
8	debounce input	input to module iomux_dfilter_0
9	prescale input	input to module iomux_prescaler_0
10	logic inputa	input to module iomux_logic_0
11	logic inputb	input to module iomux_logic_0
12	mft_txd	output
13	pulseloop_hw_trigger	input to module iomux_pulseloop_0
14	pulseloop_hw_trigger	input to module iomux_pulseloop_1
15	pulseloop_hw_trigger	input to module iomux_pulseloop_2
16	pulseloop_hw_trigger	input to module iomux_pulseloop_3
17	rxd_to_uart2	output (uart2_in)

* for physical number of open drain outputs refer to pinout or [specifications](#)

Example of an IOMUX configuration

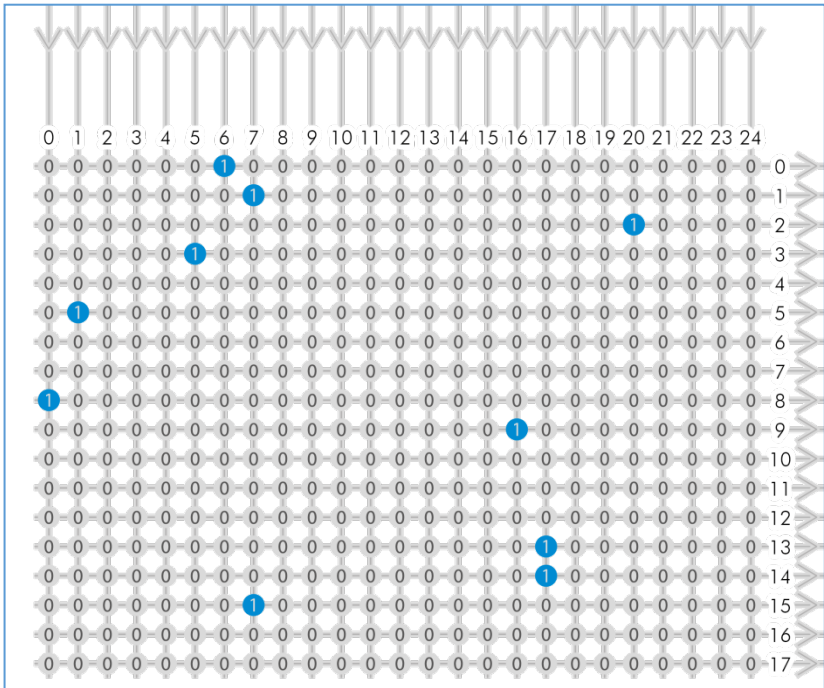

- > The trigger signal comes in on line 0
- > Debounce it.
connect line 0 to 8:
10000000000000000000000000000000
signal appears again on line 15 – debouncer out
- > Use the prescaler to act only on every second pulse.
connect line 16 to 9.
000000000000000000001000000000
signal appears again on line 17 – debouncer out
- > Configure a strobe illumination with pulseloop module 0
connect line 17 to 13
signal from pulse loop module 0 appears on line 6
- > Set an exposure signal with pulseloop module 1.
connect line 17 to 6

- > Tell another component that the camera is exposing the sensor.
connect line 17 to 14
signal from pulse loop module 1 appears on line 7
connect line 7 to 1 (output 1)
- > Turn of a light that was ON during the time between two pictures.
connect line 17 to 15
invert signal from pulse loop module 2
it appears on line 20
connect line 20 to 2 (output 2)

Inverter & Set-to-1

Inverter and “set to 1” is part of every input and every output of the modules included in the IOMUX.

INVERTER

The inverter enabled at a certain line provides the reverse signal to or from a module.

SET TO “1”

With set to “1” enabled in a certain line, this line will provide a high signal no matter what signal was connected to the line before.

SET TO “1” – INVERS

The inverse of a set to “1” line will occur as a low signal, regardle the actual signal that came to the inverter modul.

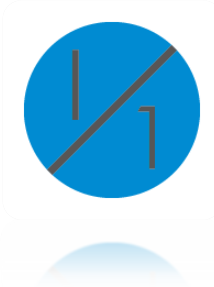

7.3.2 Strobe Control

Drive LED lights from within your camera. Control them via ethernet.

- > SVCam cameras provide a flash controller integrated into the camera, saving money and hassle
- > Maximum current of up to 3 Amperes @ 40ms
- > High frequency pulse width modulation (PWM) for no flickering
- > Less cables
- > Setting of pulse and duty cycle is controlled via the SVCam program or SVCam library
- > Only one programming interface for camera and flash
- > LED-lights can be controlled over 4 different channels that can be used simultaneously or independent from each other
- > According to the I/O specification of your camera two or four channels can be used as open drain. Refer to [specifications](#).



Figure 1: use the breakout box to simplify your wiring

4 IO high voltage drain

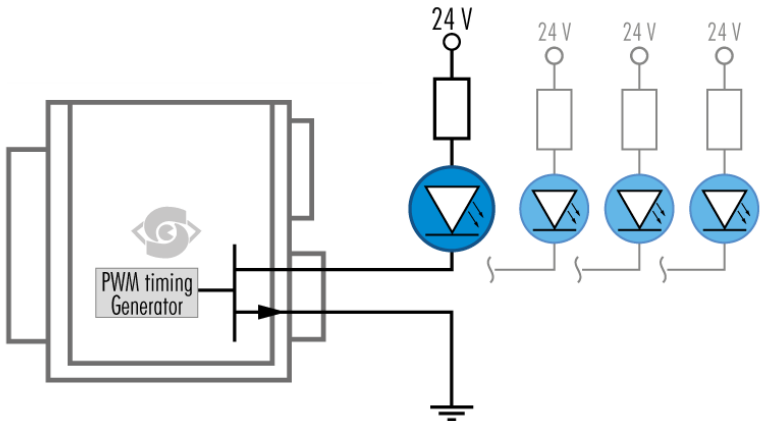

Figure 47: Illustration of four LEDs switched internal by the camera

For detailed connector pin out refer to [Connectors](#).

For further information using the **breakout box** and simplifying OIs refer **SVCam Connectivity** manual. To be found separate within the USP manuals.

USE RIGHT DIMENSION OF RESISTOR!

Protect your display from damage by selecting the appropriate resistor dimension. The PWM output will put full operational voltage to the LED display!

schematic electrical circuit - conventional system single channel

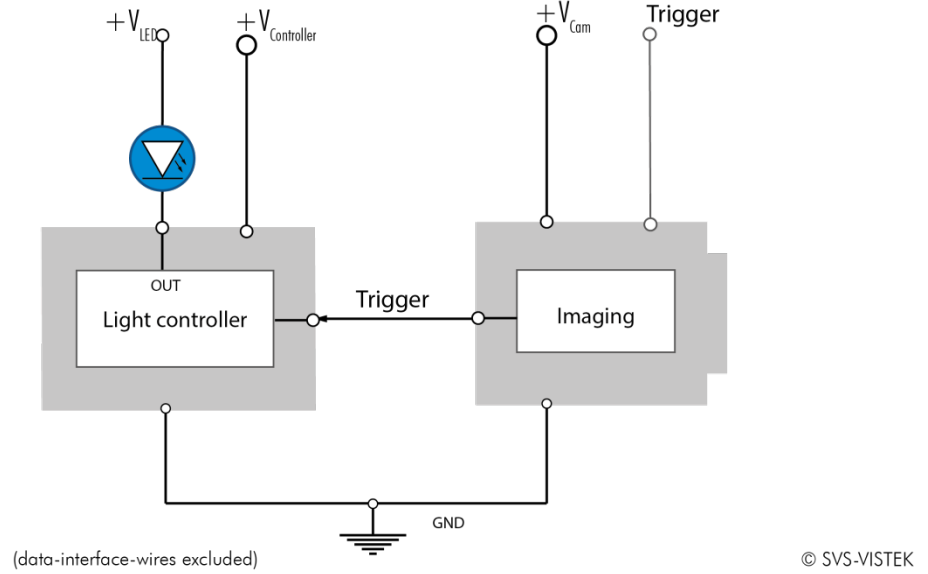

Figure 48: Illustration of conventional schematic electric circuit

schematic electrical circuit - 4IO single channel

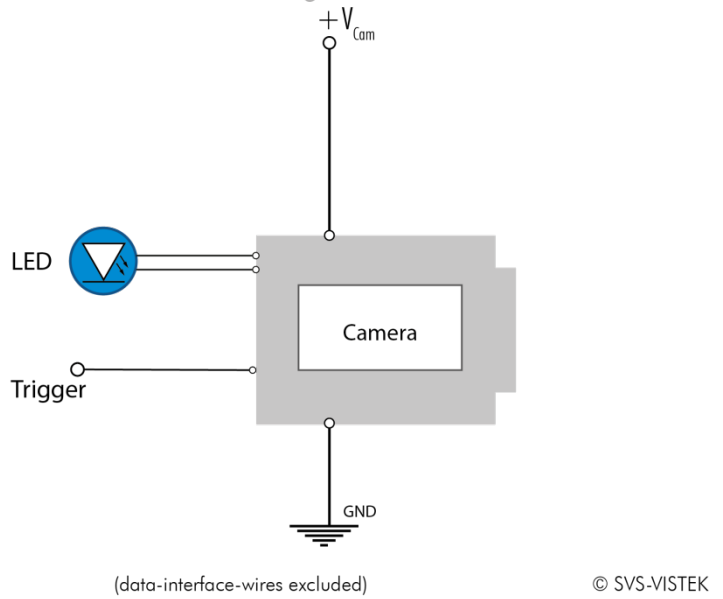

Figure 2: 4IO simplifies light control

schematic wiring - SVS-VISTEK 4IO with breakout box

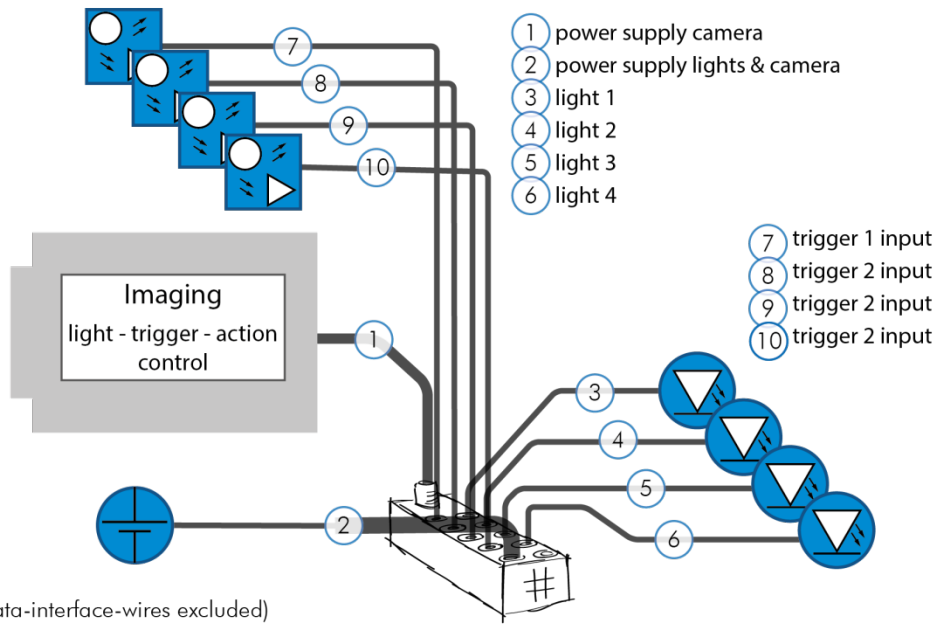

Figure 3: Illustration of schematic wiring with 4IO model using the break out box (matrix)

The pulseloop module

A fully programmable timer/counter function with four individual pulse generators (pulseloop0 - 3) that can be combined with all SVCam I/O functions, as well as physical inputs and outputs. All timing settings are programmable in 15ns intervals.

PROGRAMMABLE PARAMETERS:

- > Trigger source (hardware or software)
- > Edge or level trigger (HW trigger)
- > Pulse output starting on low or high level
- > Pre and post duration time
- > Number of loops

EXAMPLE APPLICATIONS

Initiated by an external trigger, the camera drives an LED illumination directly from the open drain output and initiates the camera exposure after a pre-defined delay.

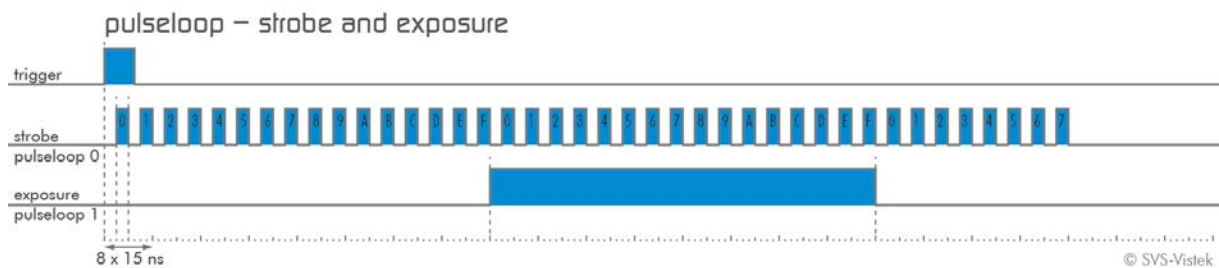

Figure 49: pulseloop for strobe and exposure

CAMERA CASCADE

Three cameras are triggered in cascade where the first camera is the master receiving the external trigger, and the master subsequently triggers the two slave cameras.

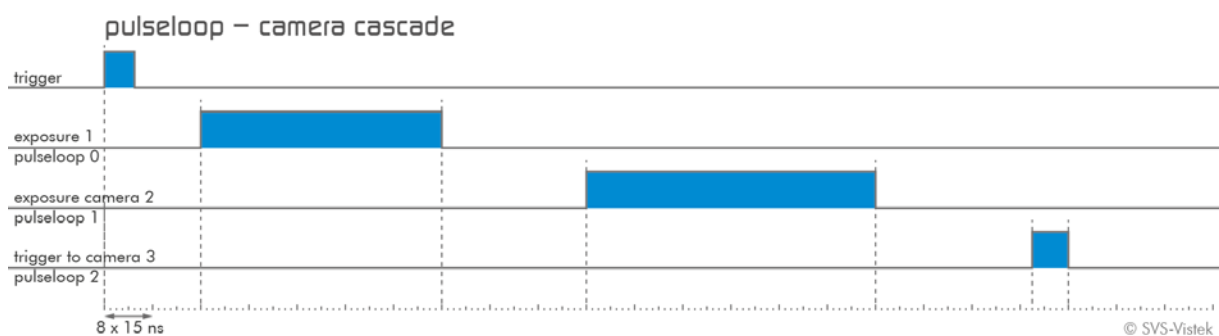
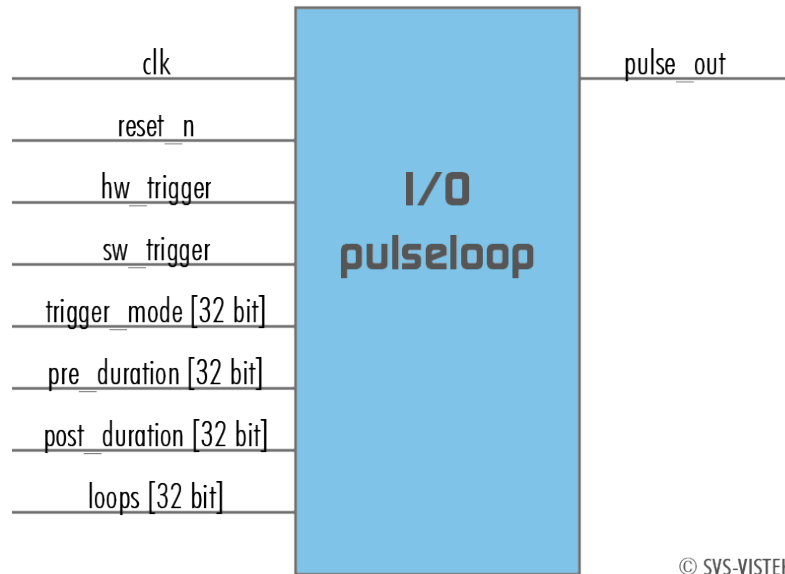

Figure 50: pulseloop – activating three cameras

MODULE PULSELOOP



LEDs in Continuous Mode

Example Calculation "No Flash" (CW Mode)

Voltage drop at 5 LEDs, 2,2 V per LED (see spec. of LED)	11 V
Max. continuous current (see spec. of LED)	250 mA
Voltage Supply	24 V
Voltage drop at Resistor (24 V – 11 V)	13 V
Pull up Resistor $R = \frac{13 V}{250 mA}$	52 Ω

Total Power ($P = U \times I$)	6 W
Power at LEDs (11 V × 250 mA)	2,75 W
Power Loss at Resistor (13 V × 250 mA)	3,25 W



USE RIGHT DIMENSION OF RESISTOR!

Protect your display from damage by selecting the appropriate resistor dimension. The PWM output will put full operational voltage to the LED display!

LEDs in Flash Mode

Most LEDs can be operated with much higher currents than spec in flash mode. This will result in more light. Please refer to the specification of your LED panel.

The MOS FETs at "OUT1" and "OUT2" are used like a "switch". By controlling "on time" and "off time" (duty cycle) the intensity of light and current can be controlled.

Current	"time ON" within a 1 Sec	PWM %
0,75 A	500 ms	50 %
1 A	300 ms	33,3 %
2 A	70 ms	7 %
3 A	40 ms	4 %

Example: If pulse is 1.5 A the max. "on" time is 150 mSec. This means the "off" time is 850 mSec. The sum of "time on" and "time off" is 1000 mSec = 1 Sec.



NOTICE

The shorter the „time on“ – the higher current can be used –the longer LEDs will work.

Strobe Timing

7.3.2.1.1 Exposure Delay

A value, representing the time between the (logical) positive edge of trigger pulse and start of integration time. Unit is 1 μ s. Default is 0 μ s.

7.3.2.1.2 Strobe Polarity

Positive or negative polarity of the hardware strobe output can be selected.

7.3.2.1.3 Strobe Duration

The exposure time of LED lights can be set in μ sec. The min duration is 1 μ sec. The longest time is 1 second.

7.3.2.1.4 Strobe Delay

The delay between the (logical) positive edge of trigger pulse and strobe pulse output can be set in μ sec. Unit is 1 μ s. Default is 0 μ s.

Strobe Control Example Setup

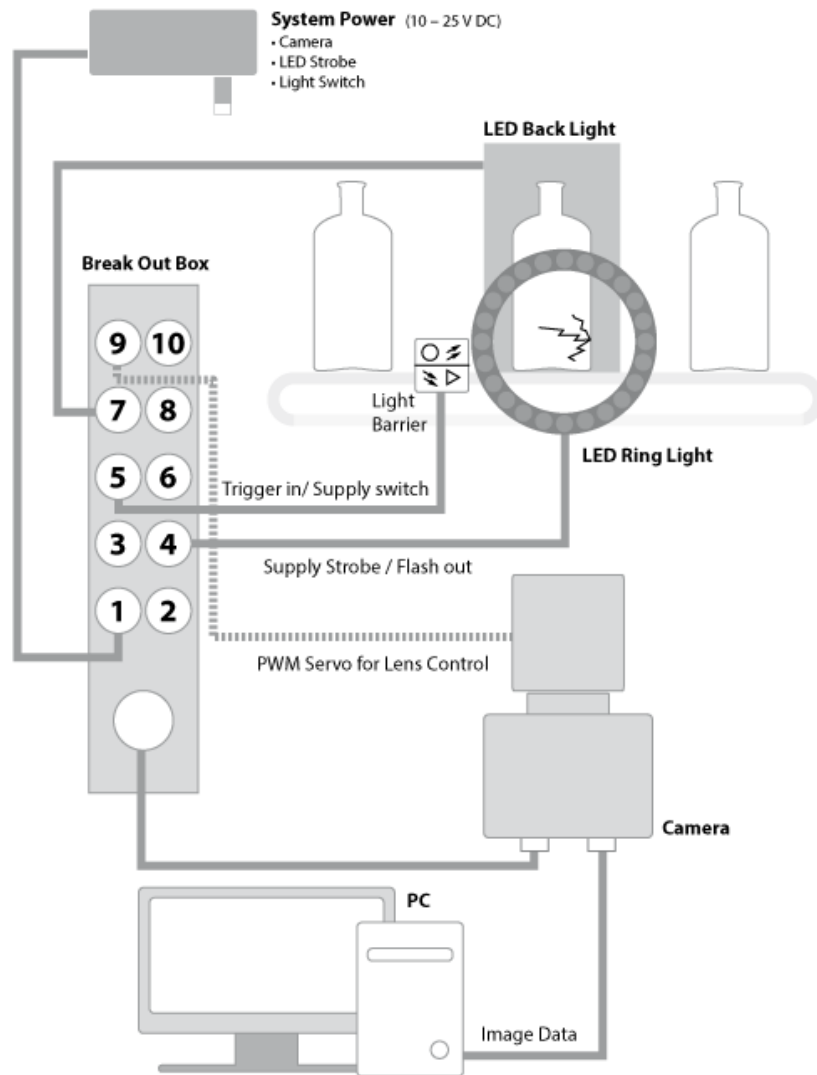

Figure 51: Illustration of an application using the 4IO

7.3.3 Sequencer

The sequencer is used when different exposure settings and illuminations are needed in a row.

E.g. the scenario to be captured may occur in three different versions and should therefore be recorded with three different light source settings. Each scenario/interval needs different illumination and exposure time.

The Sequencer allows not only detecting which scenario just appeared. Depending on the scenario there will be one optimal image for further analyzes.

Values to set	Unit	Description
Sequencer Interval	μs	Duration of the Interval
Exposure Start	μs	Exposure delay after Interval start
Exposure Stop	μs	Exposure Stop related to Interval Start
Strobe Start	μs	Strobe delay after Interval start
Strobe Stop	μs	Strobe Stop related to Interval Start
PWM Frequency	T	Basic duty cycle (1 / Hz) for PWM
PWM Line 1	%	Demodulation Result
PWM Line 2	%	Demodulation Result
PWM Line 3	%	Demodulation Result
PWM Line 4	%	Demodulation Result

Values can be set for every scenario/interval

When setting "Exposure Start" and "Stop" consider 'read-out-time'. It has to be within the Sequencer Interval.

- > Trigger Input can be set with the 4IO feature set
- > For physical trigger input refer to pinout or [specifications](#)
- > After trigger signal all programmed Interval will start.
- > Up to 16 Intervals can be programmed.

Sequencer settings can be saved to EPROM or to desktop

Example:

Values to set	Interval 0	Interval 1	Interval 2
Sequencer Interval	1.000.000 μ s (1s)	1.000.000 μ s (1s)	1.000.000 μ s (1s)
Exposure Start	220.000 μ s	875.000 μ s	190.000 μ s
Exposure Stop	700.000 μ s	125.000 μ s	720.000 μ s
Strobe Start	110.000 μ s	125.000 μ s	350.000 μ s
Strobe Stop	875.000 μ s	875.000 μ s	875.000 μ s
PWM			
Frequency	4 Hz	4 Hz	4 Hz
PWM Line 0	100	0	80
PWM Line 1	20	50	0
PWM Line 2	0	100	30
PWM Line 3	-	-	-
Trigger set to negative slope		Use higher frequencies	

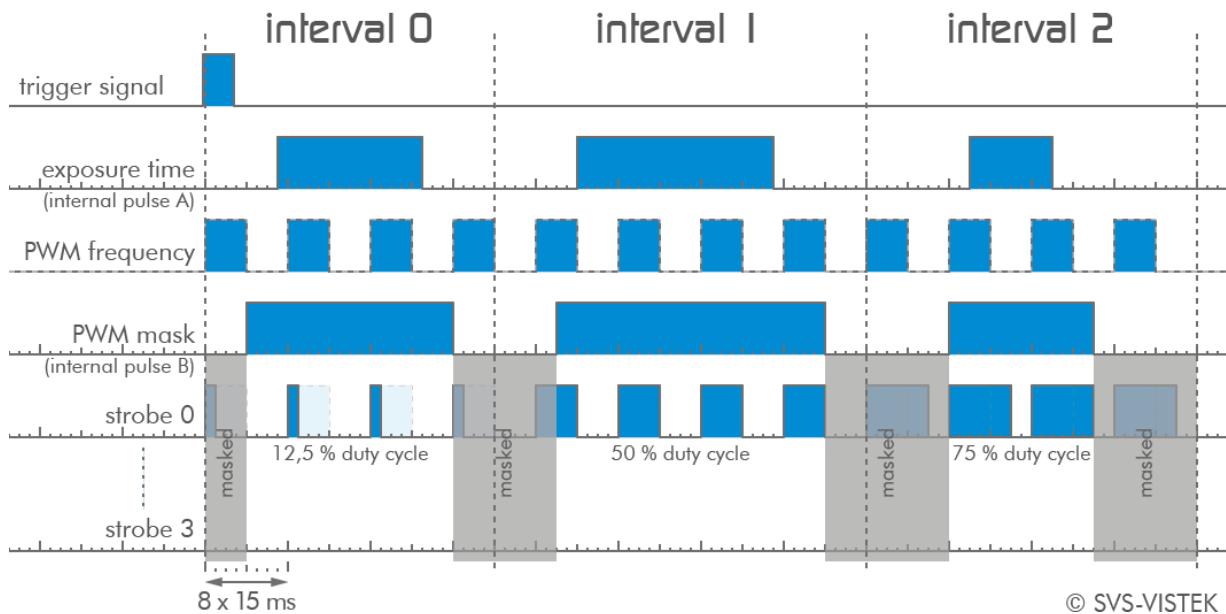

Figure 52: illustration of three sequencer intervals

7.3.4 PWM

Pulse width modulation

Description of the function used within the sequencer or implemented by the pulseloop module

During Pulse Width Modulation, a duty cycle is modulated by a fixed frequency square wave. This describes the ratio of ON to OFF as duty factor or duty ratio.

Why PWM?

Many electrical components must be provided with a defined voltage. Whether it's because they do not work otherwise or because they have the best performance at a certain voltage range (such as diodes or LEDs).

Diode characteristic

Since LEDs have a bounded workspace, the PWM ensures a variable intensity of illumination at a constant voltage on the diodes.

In addition, the lifetime of a diode increases. The internal resistance is ideal in this area. The diode gets time to cool down when operated with a PWM in its workspace.

Implementation of PWM

Modulation frequency:

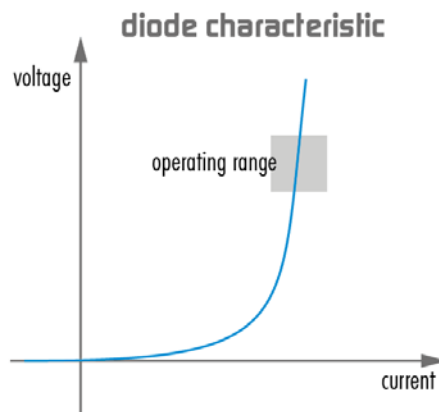

The basic frequency of the modulation is defined by the cycle duration "T".

$$T_{PWM} = \frac{1}{f_{PWM}}$$

Cycle duration "T" is written into the registry by multiple of the inverse of camera frequency. (15 ns steps) Refer to: [Time unit of the camera](#).

$$T_{PWM} = \frac{1}{66,6MHz} \cdot PWMMax[SeqSelector] \\ = 15 ns \cdot PWMMax[SeqSelector]$$

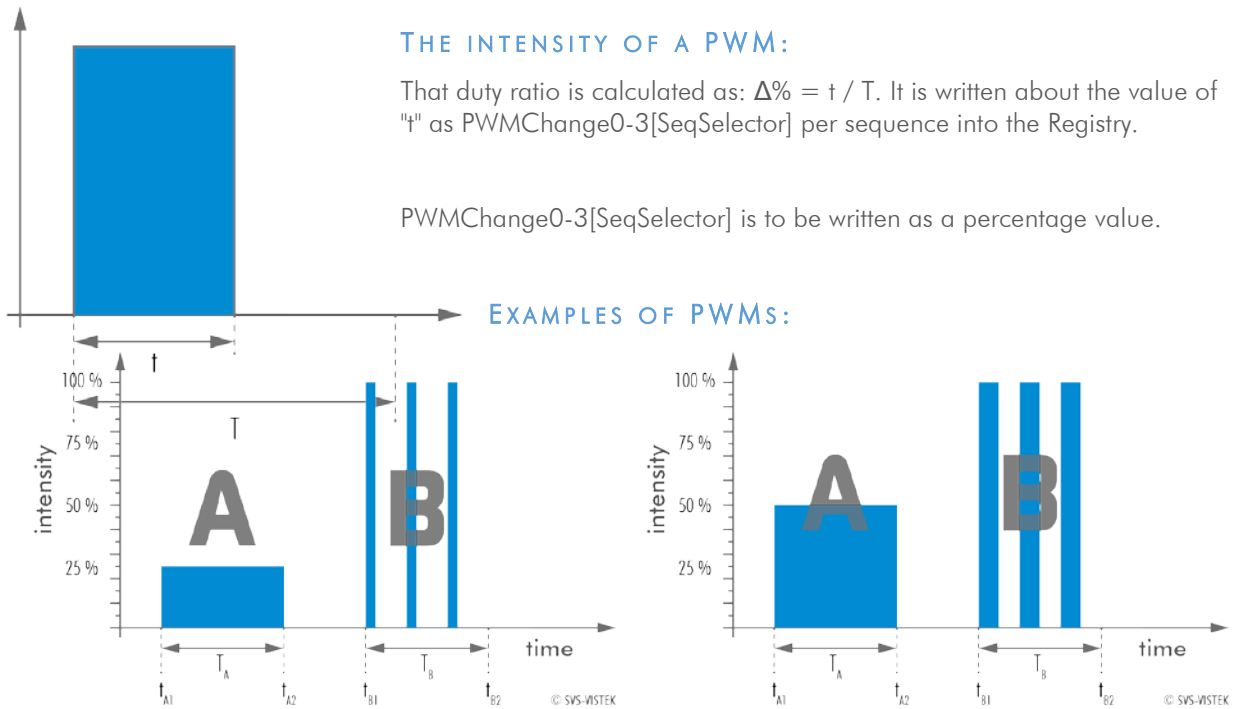

Figure 53: 25 % intensity

Figure 54: 50 % intensity

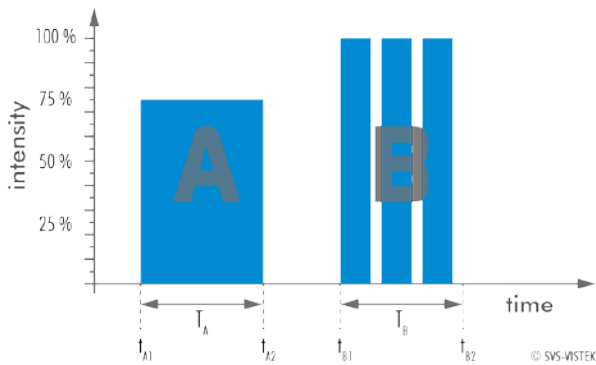

Figure 55: 75 % intensity

The integrals over both periods T_A and T_B are equal.

$$\int_{t_{A1}}^{t_{A2}} A = \int_{t_{B1}}^{t_{B2}} B$$

An equal amount of Photons will be emitted. The intensity of light is the same.

$$t_{A2} - t_{A1} = t_{B2} - t_{B1}$$

The periods T_A and T_B are equal in length.

THE PWM MODULE:

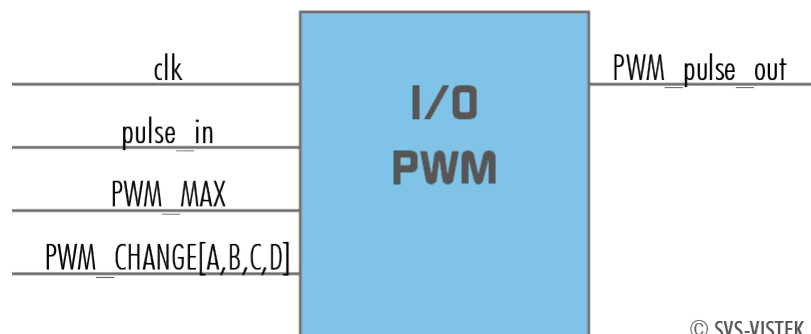

© SVS-VISTEK

7.3.5 Optical Input

An optical input is designed for galvanic separation of camera and triggering device. Noise, transients and voltage spikes might damage your components. Also trigger signal interpretation can be difficult with unclear voltage potentials within a system. The benefit of an optical input is to avoid all

these kinds of interaction from power sources or switches. The disadvantage of an optical input is that it is slower in terms of signal transmission than a direct electrical connection.

An optical input needs some current for operation. The SVS-Vistek optical input is specified to 5-24V, 8mA.

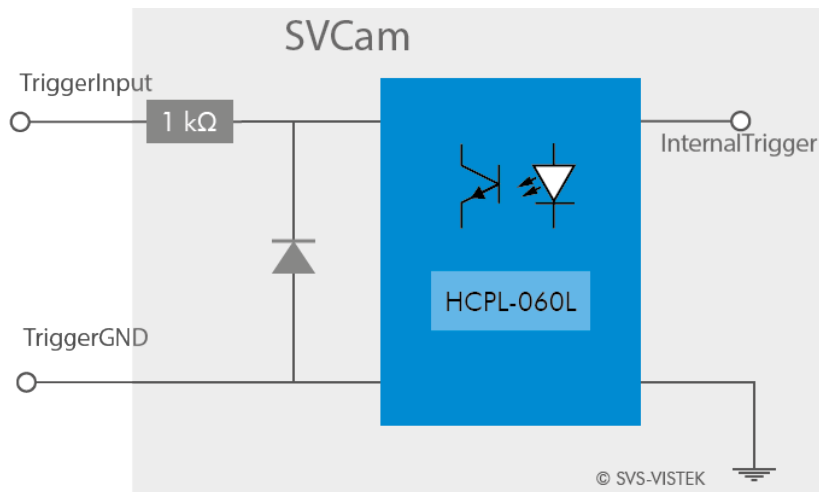

The opto coupler galvanically divides electrical circuits by emitting light on one side and interpreting light in the other. There is no direct electric interaction between both electrical circuits.

Figure 4 Optical input schematics

7.3.6 PLC/Logical Operation on Inputs

The logic input combines trigger signals with Boolean algorithms. The camera provides AND, NAND, OR, NOR as below. You might connect 2 signals on the logic input. The result can be connected to a camera trigger signal or it may be source for the next logical operation with another input. It is possible to connect it to an OUT line as well.

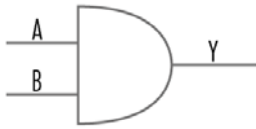

AND

Both trigger inputs have to be true.

A	B	$Y = A \wedge B$
0	0	0
0	1	0
1	0	0
1	1	1

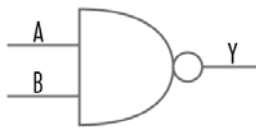
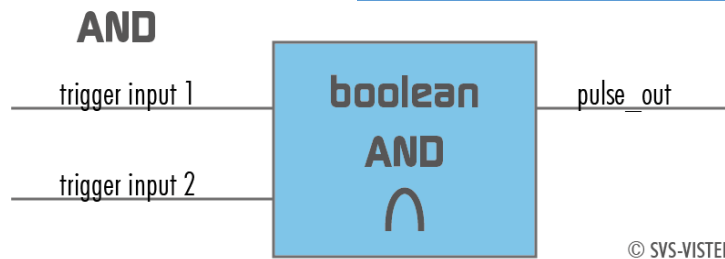

NAND

The **NEGATIVE-AND** is true only if its inputs are false.

Invert the output of the AND module.

A	B	$Y = A \text{ NAND } B$
0	0	1
0	1	1
1	0	1
1	1	0

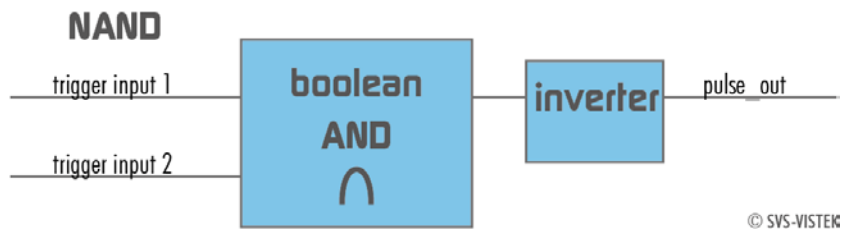



OR

If neither input is high, a low pulse_out (0) results.

Combine trigger input one and two.

A	B	$Y = A \vee B$
0	0	0
0	1	1
1	0	1
1	1	1

OR



© SVS-VISTEK



NOR

No trigger input – one nor two – results in a high or a low level pulse_out.

Invert both trigger inputs. By inverting the resulting pulse_out you will get the NOR i pulse

A	B	$Y = A \bar{\vee} B$	NOR	$Y = A \vee B$	NOR i
0	0	1		0	
0	1	0		1	
1	0	0		1	
1	1	0		1	

NOR

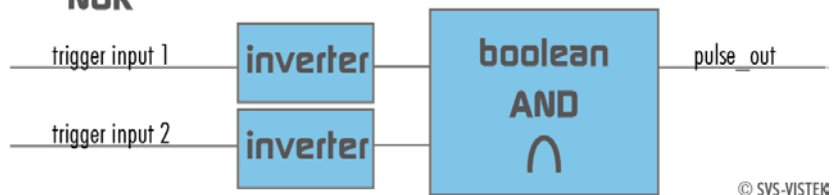

© SVS-VISTEK

NOR i

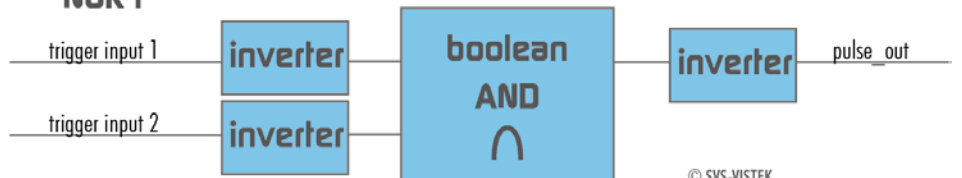

© SVS-VISTEK

7.3.7 Serial data interfaces

(ANSI EIA/) TIA-232-F

RS-232 and RS-422 (from EIA, read as Radio Sector or commonly as Recommended Standard) are technical standards to specify electrical characteristics of digital signaling circuits.

In the SVCam's these signals are used to send low-power data signals to control light or lenses (MFT).

Serial interface Parameter	RS-232	RS-422
Maximum open-circuit voltage	± 25 V	± 6 V
Max Differential Voltage	25 V	10 V
Min. Signal Range	± 3 V	2 V
Max. Signal Range	± 15 V	10 V

Table 3: serial interface parameter – RS-232 and RS-422

RS-232

It is splitted into 2 lines receiving and transferring Data.

RXD receive data

TXD transmit data

Signal voltage values are:

low: -3 ... -15 V

high: +3 ... +15 V

With restrictions: refer to Table: serial interface parameter above.

Data transport is asynchronous. Synchronization is implemented by first and last bit of a package. Therefore the last bit can be longer, e.g. 1.5 or 2 times the bit duration). Data rate (bits per second) must be defined before transmission.

UART

Packaging Data into containers (adding start and stop bits) is implemented by the UART (Universal Asynchronous Receiver Transmitter)

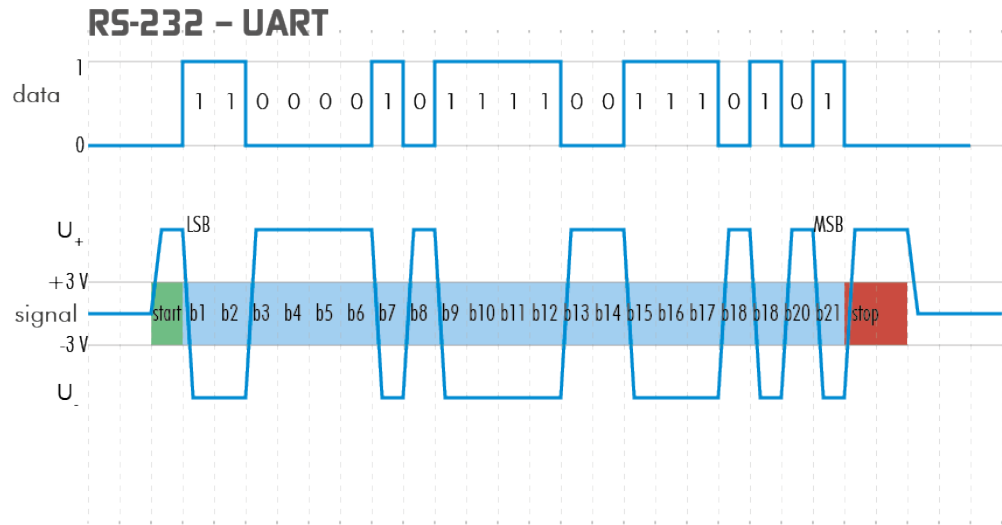

Figure 56: UART encoding of a data stream

RS-422

RS-422 is a differential low voltage communication standard.

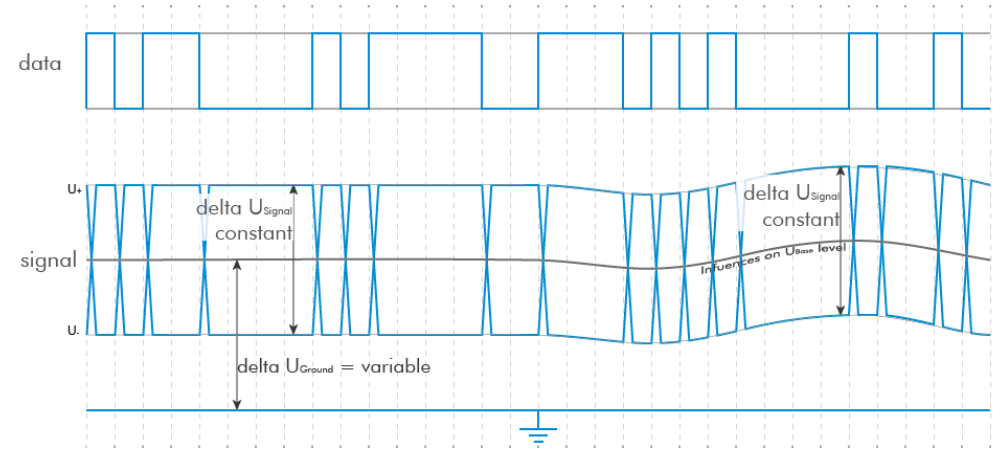

Figure 57: LVDS signal – no return to zero volt

Refer to [specifications](#) to see if RS-422 is implemented in your camera.

7.3.8 Trigger-Edge Sensitivity

Trigger-Edge Sensitivity is implemented by a “schmitt trigger”. Instead of triggering to a certain value Schmitt trigger provides a threshold.

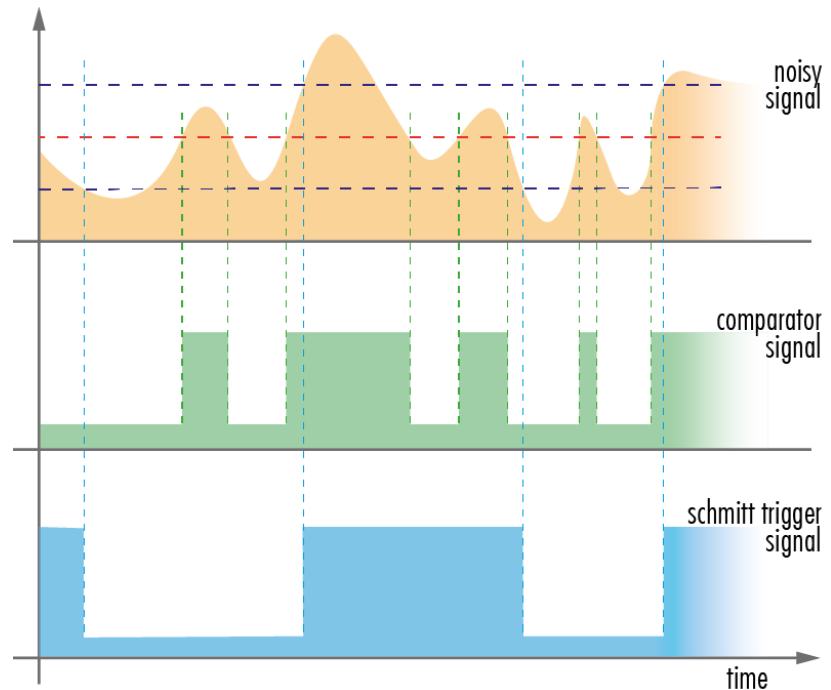

Figure 58: illustration of schmitt trigger noise suspension - high to low | low to high

7.3.9 Debouncing Trigger Signals

Bounces or glitches caused by a switch can be avoided by software within the SVCam.

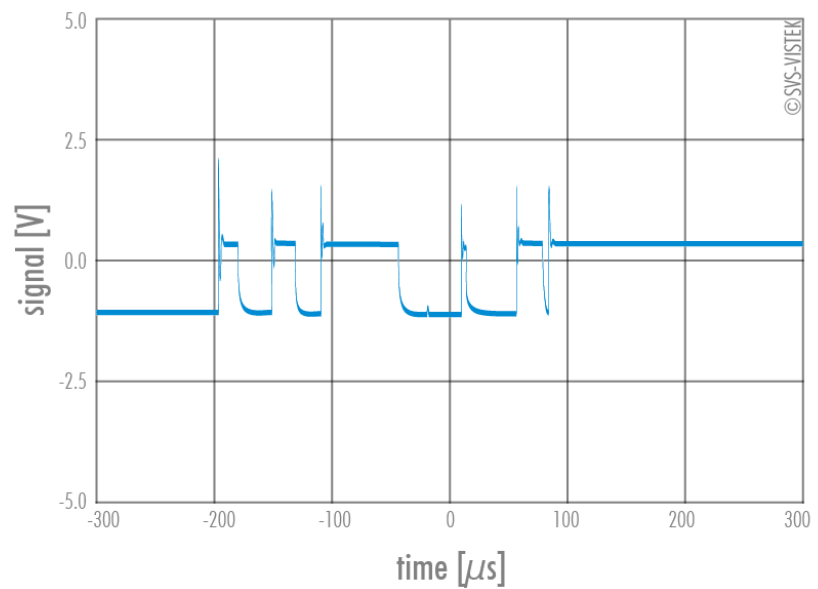

Figure 59: bounces or glitches caused by a switch during 300 μ s

Therefore the signal will not be accepted till it lasts at least a certain time.

Use the IO Assignment tool to place and enable the debouncer module in between the "trigger" (schmitt trigger) and the input source (e.g.: line 1).

DebounceDuration register can be set in multiples of 15ns (implement of system clock). E.g. 66 666 \approx 1 ms

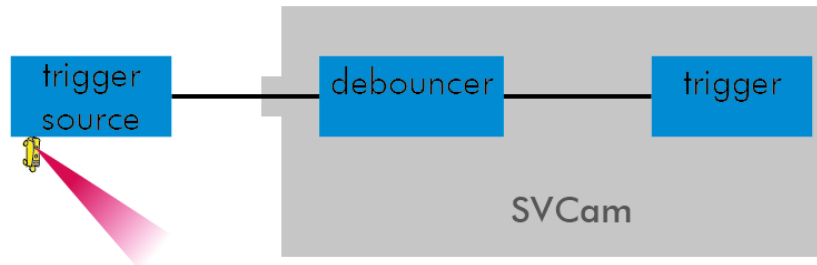
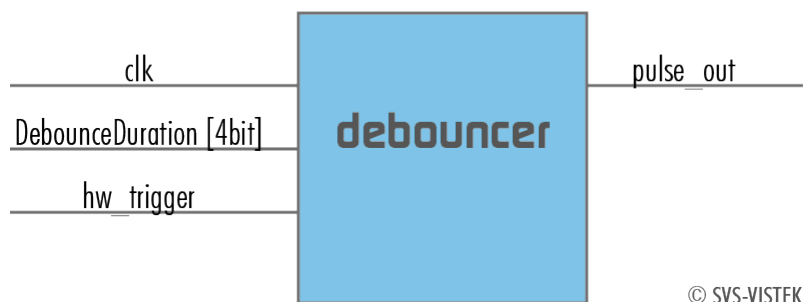

Figure 60: block diagram – debouncer in between the trigger source and the trigger

The Debouncer module



© SVS-VISTEK

Figure 61: Illustration of the debouncer module

7.3.10 Prescale

The Prescaler function can be used for masking off input pulses by applying a divisor with a 4-bit word, resulting in 16 unique settings.

- > Reducing count of interpreted trigger signal
- > Use the prescaler to ignore a certain count of trigger signals.
- > Divide the amount of trigger signals by setting a divisor.
- > Maximum value for prescale divisor: is 16 (4 bit)

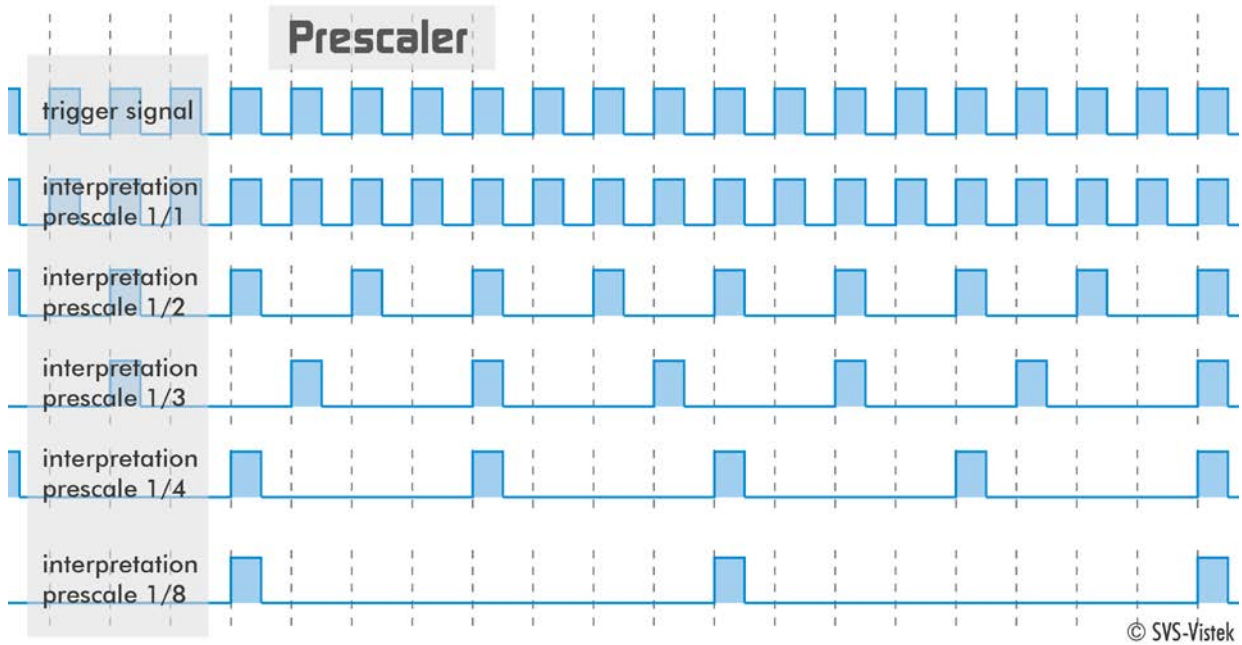

Figure 62: illustration of prescale values

The prescale module

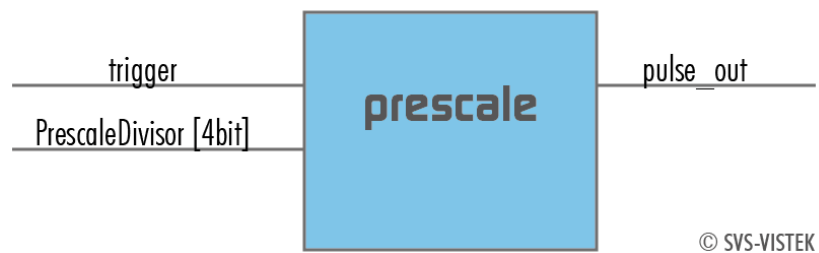

Figure 63: Illustration of the prescale module

7.4 IR Cut Filter

To avoid influences of infrared light to your image, cameras are equipped with an IR cut filter or an anti-reflection coated glass (AR filter).

- > The EXO monochrome comes by default with an AR-Filter (anti reflex)
- > The EXO color version comes by default with an IR-cut-filter

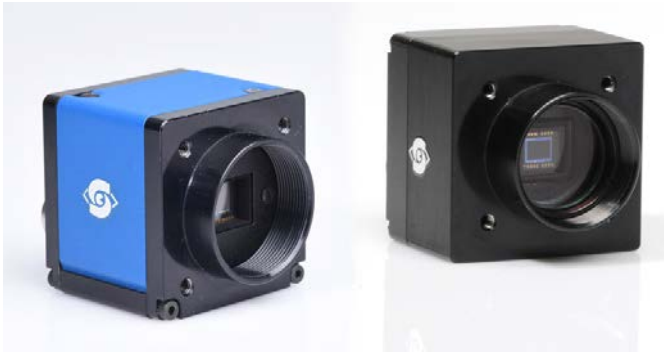
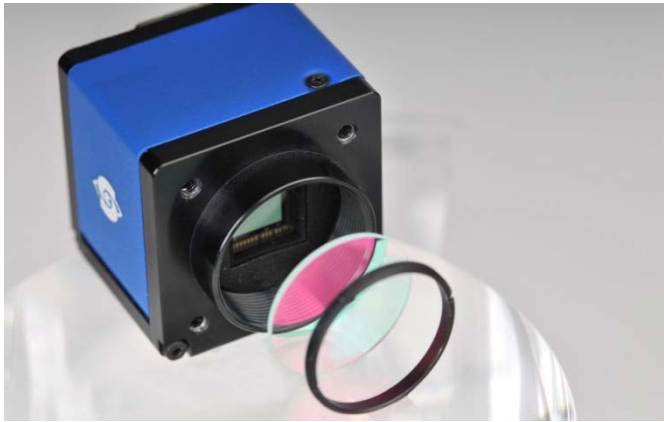

Figure 64: ECO standard & ECO Blackline with IR cut filter

In addition filters raise the protection class of the camera by protecting the sensor and camera internals from environmental influences. IP67 models do have an IR cut filter by default.

Please refer to your camera order to see if a filter is built in. Alternatively take a close look on the sensor. Build-in IR-filters are screwed within the lens mount. (See figure below)



All kinds of filter can be ordered and placed in front of the sensors. Please refer to your local distributor.

i **NOTICE**
As the sensor is very sensitive to smallest particles, avoid dust when removing the lens or the protection cap

Image Impact of IR Cut Filter

As a reason of chromatic aberration limiting the spectral bandwidth of the light always results in sharper images.

Without an IR cut filter:

- > Monochrome sensor images get muddy.
- > Chroma sensor images get influenced by a greater amount of red than you would see with your eyes. White balance gets much more difficult. Contrasts get lost because of IR light influencing also blue and green pixels.

SVS-VISTEK recommends IR cut filter for high demands on color or sharpness whether monochrome or color sensors.

Spectral Impact of IR Cut Filters

IR cut filter do influence the spectral sensitivity of the sensor. The spectral graph below shows the wavelength relative impact of the SVS-VISTEK standard filter.

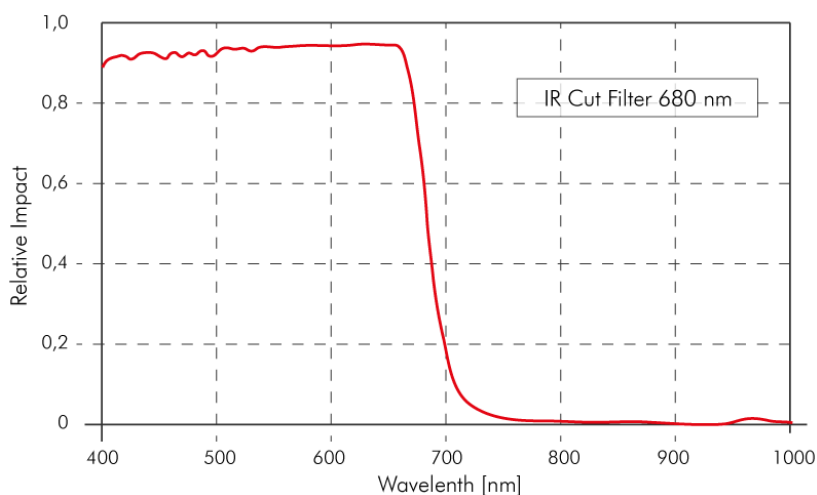

Figure 65: Diagram of light transmission – IR cut filter

Focal Impact of Filters

As an IR cut filter mainly consist of a small layer of glass (1 mm thick) there is an impact on the flange focal distance. Refraction within the layer cause shortening this distance.

When ordering a standard camera with an extra IR cut filter you might have to compensate the focal length with an extra ring. Please refer to your local distributor for more detailed information on your camera behaving on C-Mount integrated filters.

As BlackLine models have an IR cut filter by default, the focal distance is compensated by default too.



NOTICE

Removing the IR cut filter lengthen the focal distance and will invalidate the warranty of your camera.

8 Specifications

All specifications can be viewed as well on our website, www.svs-vistek.com We are proud to have ongoing development on our cameras, so specs might change and new features being added.

8.1 EX0694*U3

Model	exo694CU3	exo694MU3
family	EXO	EXO
active pixel w x h	2752 x 2200	2752 x 2200
max. frame rate	25 fps	25 fps
chroma	color	mono
interface	USB3 Vision	USB3 Vision
sensor name	ICX694AQG	ICX694ALG
sensor manufacturer	Sony	Sony
sensor architecture	Area CCD	Area CCD
shutter type	progressive scan	progressive scan
equivalent format	1"	1"
diagonal	16,0 mm	16,0 mm
pixel w x h	4,54x4,54 μm	4,54x4,54 μm
optic sensor w x h	14,6x12,8 mm	14,6x12,8 mm
exposure time	42 μs / 1s	42 μs / 1s
max. gain	18 dB	18 dB
dynamic range	62 dB	62 dB
S/N Ratio	41	41
frame buffer	256 MB	256 MB
CL_geometry	-	-
frequency select	-	-
camera pixel clock	54 MHz	54 MHz
exp. time adjustment	manual;auto;external	manual;auto;external
px format 8 / 12 / 16	x / x / -	x / x / -
packed readout	-	-
max binning h / v	2 / 2	2 / 2
LUT	12to8(1)	12to8(1)
ROI	1	1
white balancing	auto;manual	-
tap balancing	-	-
gain	auto;manual	auto;manual
black level	manual	manual
PIV mode	-	-
readout control	-	-
flat field correction	-	-
shading correction	-	-
defect pixel correction	-	-
image flip	horizontal;vertical	horizontal;vertical

trigger modes	internal;software;external	internal;software;external
trigger edge high / low	x / x	x / x
sequencer	x	x
PWM power out	x	x
trigger IN TTL-24 V	2	2
outputs open drain	4	4
optical in / out	1 / -	1 / -
RS-232 in / out	1 / 1	1 / 1
RS-422 in / out	- / -	- / -
power supply	10...25 V	10...25 V

lens mount	C-Mount	C-Mount
dynamic lens control	-	-
size w / h / d (1)	50x50x41,16 mm	50x50x41,16 mm
weight	138 g	138 g
protection class	IP40	IP40
power consumption	5,0 W	5,0 W
ambient temperature		
housing temperature	-10... 60°C	-10... 60°C
status	production	production

(1) please refer to model drawings

© SVS-VISTEK

February 23, 2017

February 23, 2017

Spectral sensitivity characteristics

Color

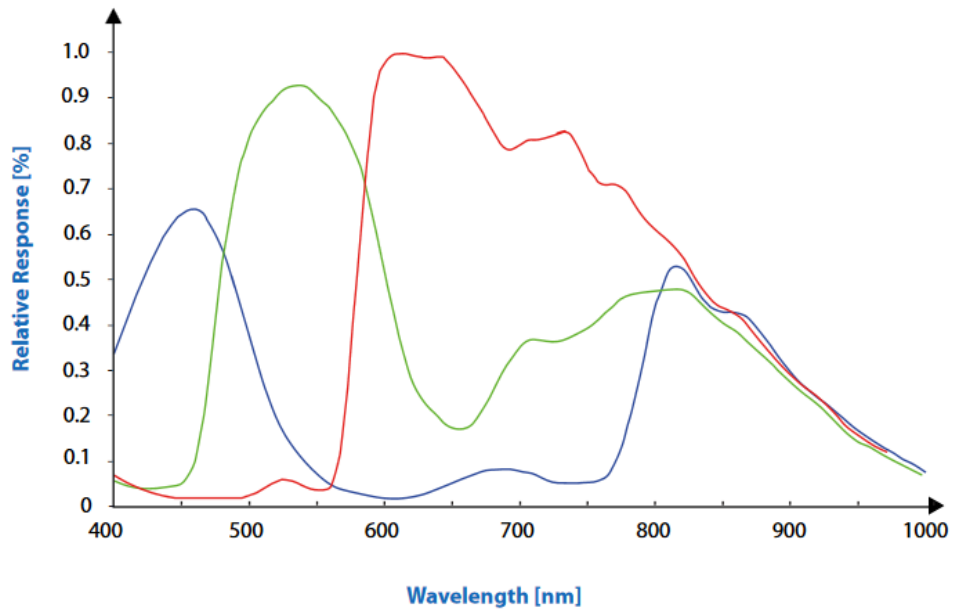

Figure 66: IMX694LQR

Mono

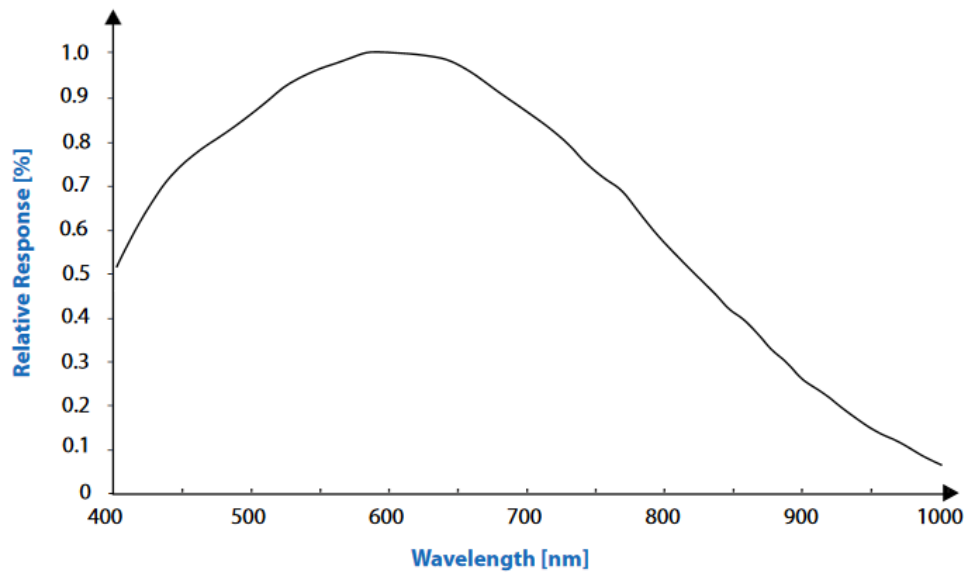

Figure 67: IMX694LLR

8.2 EX0695*U3

Model	exo695CU3	exo695MU3
family	EXO	EXO
active pixel w x h	2752 x 2200	2752 x 2200
max. frame rate	13 fps	13 fps
chroma	color	mono
interface	USB3 Vision	USB3 Vision

sensor name	ICX695AQG	ICX695ALG
sensor manufacturer	Sony	Sony
sensor architecture	Area CCD	Area CCD
shutter type	progressive scan	progressive scan
equivalent format	1"	1"
diagonal	16,0 mm	16,0 mm
pixel w x h	4,54x4,54 μm	4,54x4,54 μm
optic sensor w x h	14,6x12,8 mm	14,6x12,8 mm
exposure time	42 μs / 1s	42 μs / 1s
max. gain	18 dB	18 dB
dynamic range	0 dB	0 dB
S/N Ratio		

frame buffer	256 MB	256 MB
CL_geometry	-	-
frequency select	-	-
camera pixel clock	54 MHz	54 MHz
exp. time adjustment	0	0
px format 8 / 12 / 16	- / - / -	- / - / -
packed readout	-	-
max binning h / v	-	-
LUT	0	0
ROI	-	-
white balancing	-	-
tap balancing	-	-
gain	0	0
black level	manual	manual
PIV mode	-	-
readout control	-	-
flat field correction	-	-
shading correction	0	0
defect pixel correction	0	0
image flip	0	0

trigger modes	internal;software;external	internal;software;external
trigger edge high / low	x / x	x / x
sequencer	x	x
PWM power out	x	x
trigger IN TTL-24 V	2	2
outputs open drain	4	4
optical in / out	1 / -	1 / -
RS-232 in / out	1 / 1	1 / 1
RS-422 in / out	- / -	- / -
power supply	10...25 V	10...25 V

lens mount	C-Mount	C-Mount
dynamic lens control	-	-
size w / h / d (1)	50x50x41,16 mm	50x50x41,16 mm
weight	138 g	138 g
protection class	IP40	IP40
power consumption	5,0 W	5,0 W
ambient temperature	-10...45°C	-10...45°C
housing temperature		
status	replaced	replaced

(1) please refer to model drawings

© SVS-VISTEK

February 23, 2017

February 23, 2017

Color

Spectral sensitivity characteristics

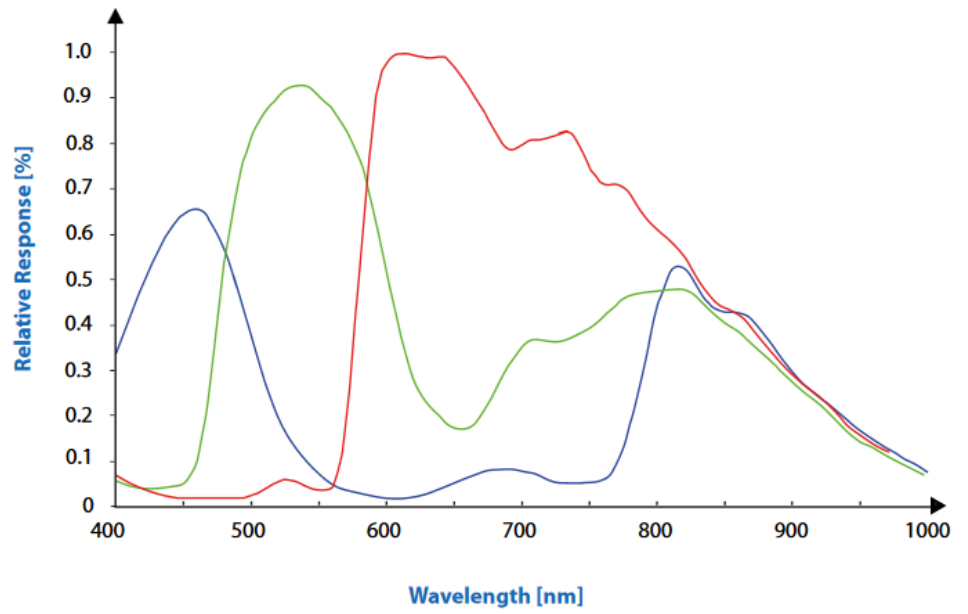

Figure 68: IMX695LQR

Mono

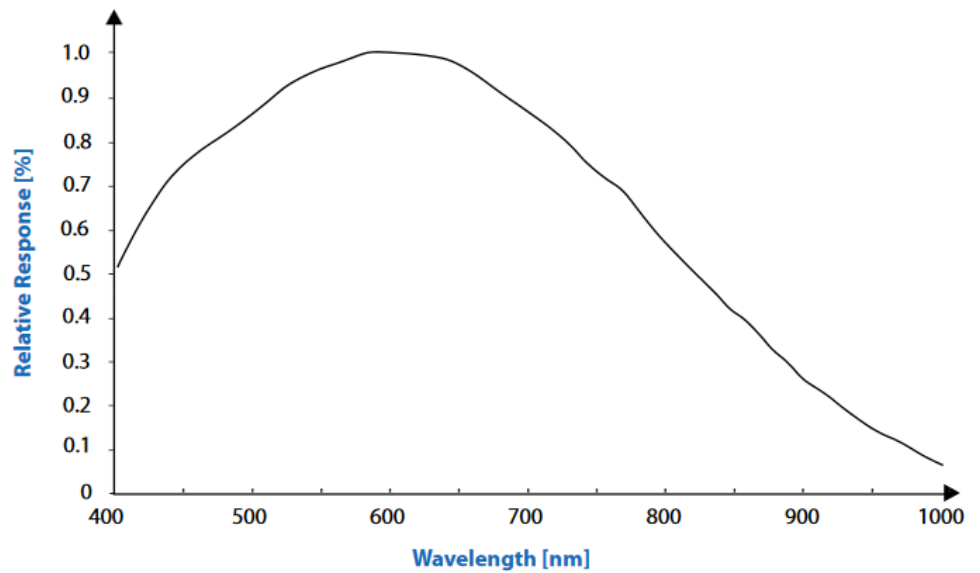

Figure 69: IMX695LLR

8.3 EX0814*U3

Model	exo814MU3	exo814CU3
family	EXO	EXO
active pixel w x h	3360 x 2712	3360 x 2712
max. frame rate	18 fps	18 fps
chroma	mono	color
interface	USB3 Vision	USB3 Vision
sensor name	ICX814ALA	ICX814AQA
sensor manufacturer	Sony	Sony
sensor architecture	Area CCD	Area CCD
shutter type	progressive scan	progressive scan
equivalent format	1"	1"
diagonal	16,0 mm	16,0 mm
pixel w x h	3,69x3,69 μ m	3,69x3,69 μ m
optic sensor w x h	14,6x12,8 mm	14,6x12,8 mm
exposure time	42 μ s / 1s	42 μ s / 1s
max. gain	18 dB	18 dB
dynamic range	61 dB	61 dB
S/N Ratio	40.48	40.68
frame buffer	256 MB	256 MB
CL_geometry	-	-
frequency select	-	-
camera pixel clock	54 MHz	54 MHz
exp. time adjustment	manual;auto;external	manual;auto;external
px format 8 / 12 / 16	x / x / -	x / x / -
packed readout	x	x
max binning h / v	-	2 / 2
LUT	12to8(1)	12to8(1)
ROI	1	1
white balancing	-	auto;manual
tap balancing	-	-
gain	auto;manual	auto;manual
black level	manual	manual
PIV mode	-	-
readout control	-	-
flat field correction	-	-
shading correction	-	-
defect pixel correction	-	-
image flip	horizontal;vertical	horizontal;vertical

trigger modes	internal;software;external	internal;software;external
trigger edge high / low	x / x	x / x
sequencer	x	x
PWM power out	x	x
trigger IN TTL-24 V	2	2
outputs open drain	4	4
optical in / out	1 / -	1 / -
RS-232 in / out	1 / 1	1 / 1
RS-422 in / out	- / -	- / -
power supply	10...25 V	10...25 V

lens mount	C-Mount	C-Mount
dynamic lens control	-	-
size w / h / d (1)	50x50x41,16 mm	50x50x41,16 mm
weight	138 g	138 g
protection class	IP40	IP40
power consumption	5,0 W	5,0 W
ambient temperature		
housing temperature	-10... 60°C	-10... 60°C
status	production	production

(1) please refer to model drawings

© SVS-VISTEK

February 23, 2017

February 23, 2017

Spectral sensitivity characteristics

Color

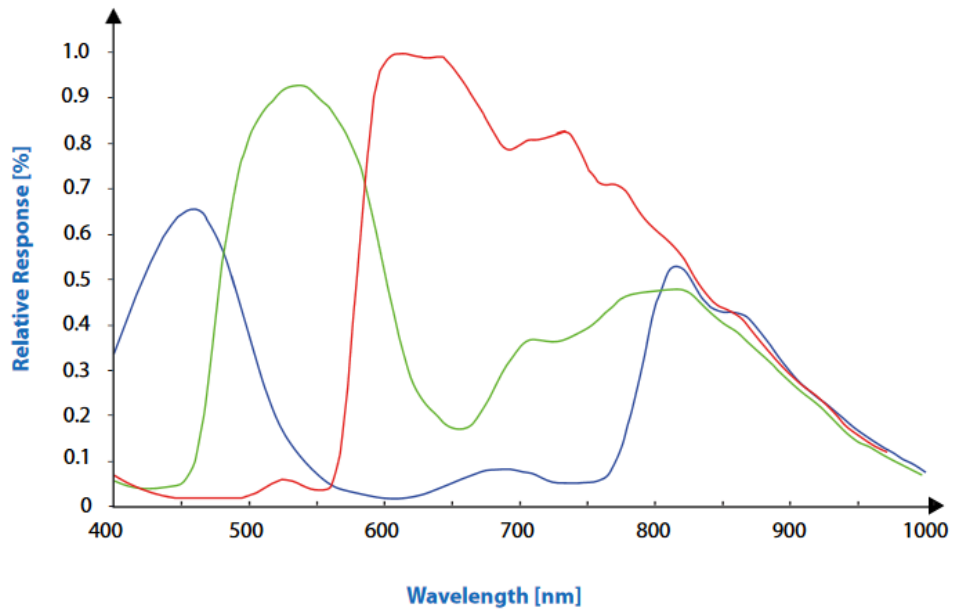

Figure 70: IMX814LQR

Mono

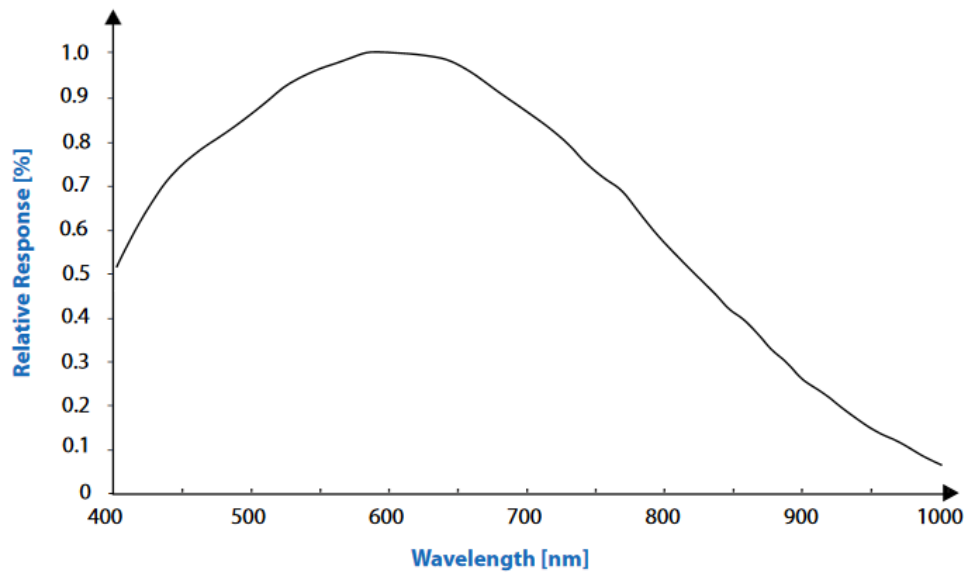

Figure 71: IMX814LLR

8.4 EX0815*U3

Model	exo815MU3	exo815CU3
family	EXO	EXO
active pixel w x h	3384 x 2704	3384 x 2704
max. frame rate	9 fps	9 fps
chroma	mono	color
interface	USB3 Vision	USB3 Vision
<hr/>		
sensor name	ICX815ALA	ICX815AQA
sensor manufacturer	Sony	Sony
sensor architecture	Area CCD	Area CCD
shutter type	progressive scan	progressive scan
equivalent format	1"	1"
diagonal	16,0 mm	16,0 mm
pixel w x h	3,69x3,69 μ m	3,69x3,69 μ m
optic sensor w x h	14,6x12,8 mm	14,6x12,8 mm
exposure time	42 μ s / 1s	42 μ s / 1s
max. gain	18 dB	18 dB
dynamic range	0 dB	0 dB
S/N Ratio		
<hr/>		
frame buffer	256 MB	256 MB
CL_geometry	-	-
frequency select	-	-
camera pixel clock	54 MHz	54 MHz
exp. time adjustment	0	0
px format 8 / 12 / 16	- / - / -	- / - / -
packed readout	-	-
max binning h / v	-	-
LUT	0	0
ROI	-	-
white balancing	-	-
tap balancing	-	-
gain	0	0
black level	manual	manual
PIV mode	-	-
readout control	-	-
flat field correction	-	-
shading correction	0	0
defect pixel correction	0	0
image flip	0	0

trigger modes	internal;software;external	internal;software;external
trigger edge high / low	x / x	x / x
sequencer	x	x
PWM power out	x	x
trigger IN TTL-24 V	2	2
outputs open drain	4	4
optical in / out	1 / -	1 / -
RS-232 in / out	1 / 1	1 / 1
RS-422 in / out	- / -	- / -
power supply	10...25 V	10...25 V

lens mount	C-Mount	C-Mount
dynamic lens control	-	-
size w / h / d (1)	50x50x41,16 mm	50x50x41,16 mm
weight	138 g	138 g
protection class	IP40	IP40
power consumption	5,0 W	5,0 W
ambient temperature	-10...45°C	-10...45°C
housing temperature		
status	replaced	replaced

(1) please refer to model drawings

© SVS-VISTEK

February 23, 2017

February 23, 2017

Spectral sensitivity characteristics

Color

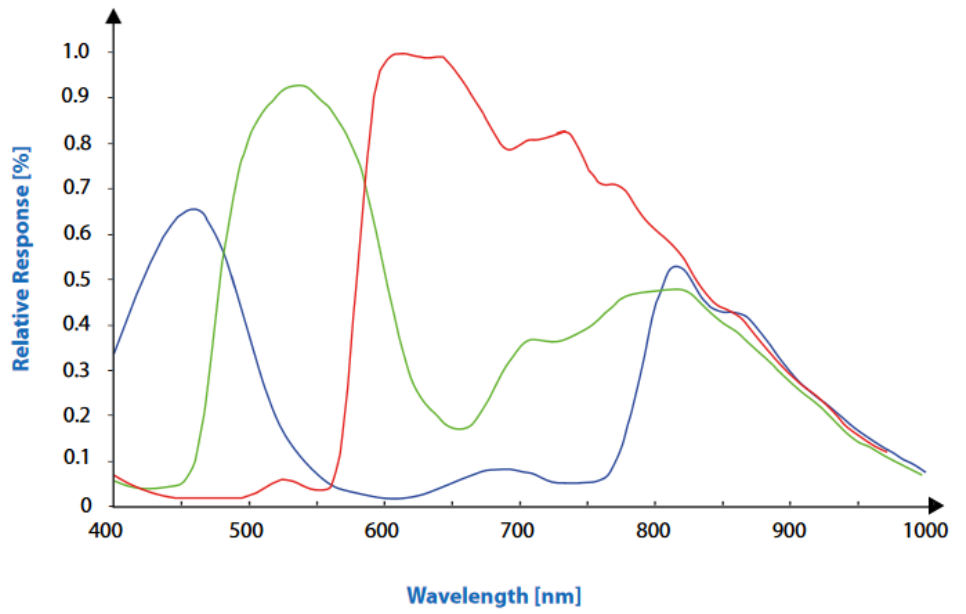

Figure 72: IMX815LQR

Mono

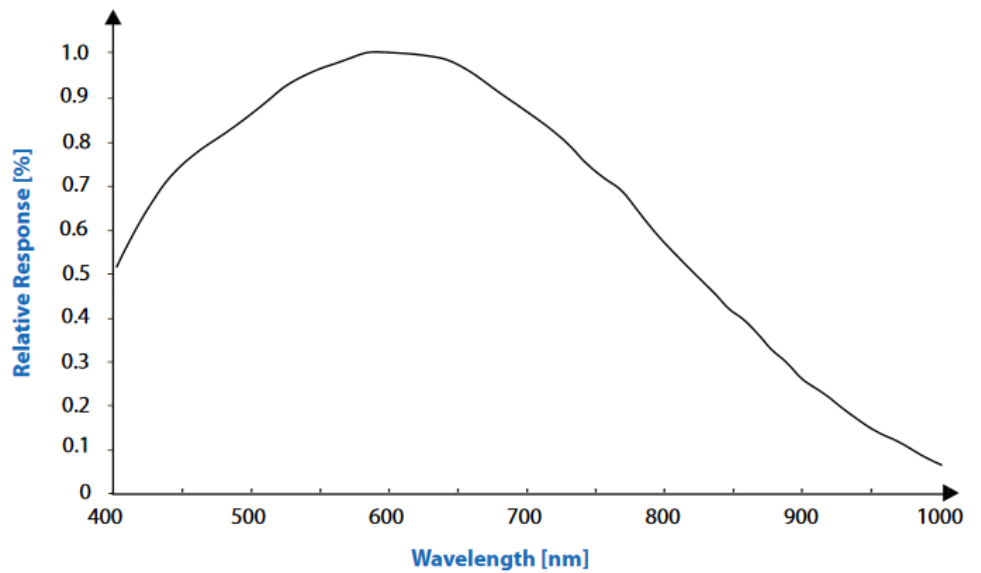

Figure 73: IMX815LLR

8.5 EX0834*U3

Model	exo834CU3	exo834MU3
family	EXO	EXO
active pixel w x h	4240 x 2830	4240 x 2830
max. frame rate	14,5 fps	14,5 fps
chroma	color	mono
interface	USB3 Vision	USB3 Vision
sensor name	ICX834AQG	ICX834ALG
sensor manufacturer	Sony	Sony
sensor architecture	Area CCD	Area CCD
shutter type	progressive scan	progressive scan
equivalent format	1"	1"
diagonal	15,8 mm	15,8 mm
pixel w x h	3,1x3,1 μm	3,1x3,1 μm
optic sensor w x h	15,3x12 mm	15,3x12 mm
exposure time	42 μs / 1s	42 μs / 1s
max. gain	18 dB	18 dB
dynamic range	0 dB	0 dB
S/N Ratio		
frame buffer	256 MB	256 MB
CL_geometry	-	-
frequency select	-	-
camera pixel clock	54 MHz	54 MHz
exp. time adjustment	manual;auto;external	manual;auto;external
px format 8 / 12 / 16	x / x / -	x / x / -
packed readout	x	x
max binning h / v	2 / 2	-
LUT	12to8(1)	12to8(1)
ROI	1	1
white balancing	auto;manual	-
tap balancing	-	-
gain	auto;manual	auto;manual
black level	manual	manual
PIV mode	-	-
readout control	-	-
flat field correction	-	-
shading correction	-	-
defect pixel correction	-	-
image flip	horizontal;vertical	horizontal;vertical

trigger modes	internal;software;external	internal;software;external
trigger edge high / low	x / x	x / x
sequencer	x	x
PWM power out	x	x
trigger IN TTL-24 V	2	2
outputs open drain	4	4
optical in / out	1 / -	1 / -
RS-232 in / out	1 / 1	1 / 1
RS-422 in / out	- / -	- / -
power supply	10...25 V	10...25 V

lens mount	C-Mount	C-Mount
dynamic lens control	-	-
size w / h / d (1)	50x50x41,16 mm	50x50x41,16 mm
weight	138 g	138 g
protection class	IP40	IP40
power consumption	5,0 W	5,0 W
ambient temperature	-10...45°C	-10...45°C
housing temperature		
status	production	production

(1) please refer to model drawings

© SVS-VISTEK

February 23, 2017

February 23, 2017

Spectral sensitivity characteristics

Color

Figure 74: IMX834LQR

Mono

Figure 75: IMX834LLR

9 Terms of warranty

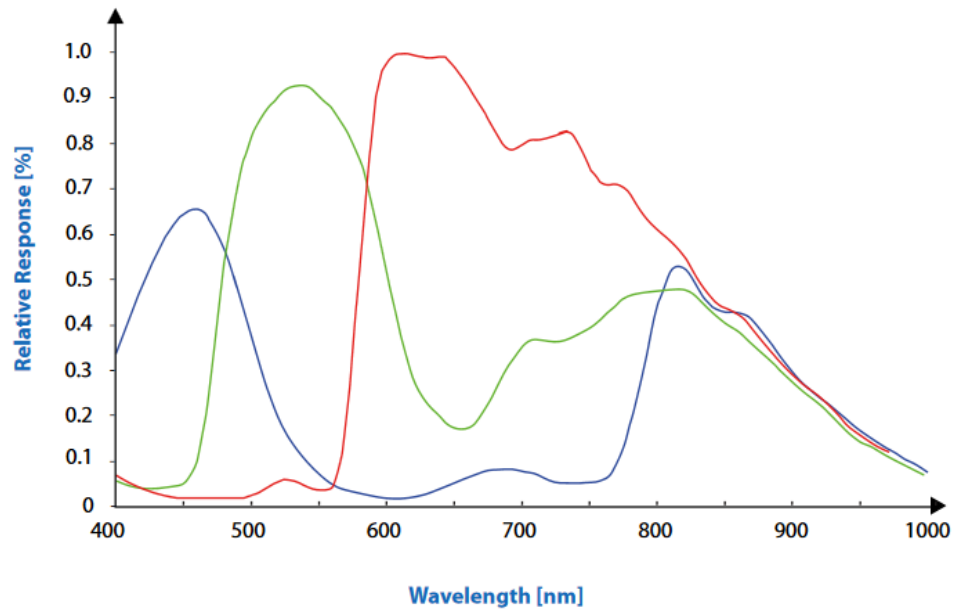
Standard Products Warranty and Adjustment	Seller warrants that the article to be delivered under this order will be free from defects in material and workmanship under normal use and service for a period of 2 years from date of shipment. The liability of Seller under this warranty is limited solely to replacing or repairing or issuing credit (at the discretion of Seller) for such products that become defective during the warranty period. In order to permit Seller to properly administer this warranty, Buyer shall notify Seller promptly in writing of any claims,; provide Seller with an opportunity to inspect and test the products claimed to be defective. Such inspection may be on customer's premises or Seller may request return of such products at customer's expense. Such expense will subsequently be reimbursed to customer if the product is found to be defective and Buyer shall not return any product without prior return authorization from Seller. If a returned product is found to be out of warranty or found to be within the applicable specification, Buyer will have to pay an evaluation and handling charge, independent of possible repair and/or replacement costs. Seller will notify Buyer of the amount of said evaluation and handling charges at the time the return authorization is issued. Seller will inform Buyer of related repair and/or replacement costs and request authorization before incurring such costs. Buyer shall identify all returned material with Sellers invoice number, under which material has been received. If more than one invoice applies, material has to be clearly segregated and identified by applicable invoice numbers. Adjustment is contingent upon Sellers examination of product, disclosing that apparent defects have not been caused by misuse, abuse, improper installation of application, repair, alteration, accident or negligence in use, storage, transportation or handling. In no event shall Seller be liable to Buyer for loss of profits, loss of use, or damages of any kind based upon a claim for breach of warranty.
Development Product Warranty	Developmental products of Seller are warranted to be free from defects in materials and workmanship and to meet the applicable preliminary specification only at the time of receipt by Buyer and for no longer period of time in all other respects the warranties made above apply to development products. The aforementioned provisions do not extend the original warranty period of any article which has been repaired or replaced by Seller.
Do not break Warranty Label	If warranty label of camera is broken warranty is void. Seller makes no other warranties express or implied, and specifically, seller makes no warranty of merchantability of fitness for particular purpose.
What to do in case of Malfunction	Please contact your local distributor first.

10 Troubleshooting

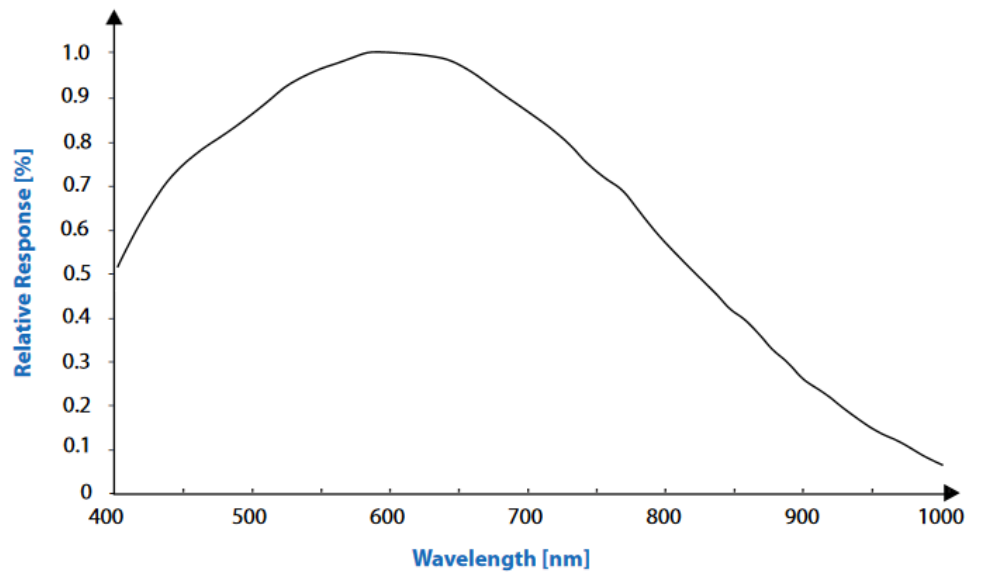
10.1 FAQ

Problem	Solution
Camera does not respond to light.	<p>Check if camera is set to "Mode 0". I.e. free running with programmed exposure ctrl. When done, check with the program "Convenient Cam" if you can read back any data from the camera, such as "Mode", "type" of CCD, exposure time settings, etc..</p> <p>If "Mode 0" works properly, check the signals of the camera in the desired operation mode like "Mode 1" or "Mode 2". In these modes, check if the ExSync signal is present. Please note that a TTL signal must be fed to the trigger connector if it is not provided by the frame grabber (LVDS type). The typical signal swing must be around 5 V. Lower levels will not be detected by the camera... If you use a TTL level signal fed to the "TB 5 connector" check the quality and swing. If these signals are not present or don't have the proper quality, the camera cannot read out any frame (Mode 1 and 2). Beware of spikes on the signal.</p>
Image is present but distorted.	<p>Check the camera configuration file of your frame grabber. Check number of "front- and back porch" pixel. Wrong numbers in configuration file can cause sync problems. Check if your frame grabber can work with the data rate of the camera.</p>
Image of a color version camera looks strange or false colors appear.	<p>If the raw image looks OK, check the camera file to see if the pixels need to be shifted by either one pixel or one line. The image depends on the algorithm used. If the algorithm is starting with the wrong pixel such effects appear.</p>
Colors rendition of a color versions not as expected – especially when using halogen light.	<p>Halogen light contains strong portions of IR radiation. Use cut-off filters at around 730 nm like "Schott KG 3" to prevent IR radiation reaching the CCD.</p>
No serial communication is possible between the camera and the PC.	<p>Use "load camera DLL" and try again.</p>

Please fax this form to your local distributor. The right Fax number you can find on our homepage: <http://www.svs-vistek.com>

10.2 Support Request Form / Check List

Dear valued customer,

In order to help you with your camera and any interfacing problems we request that you fill in a description of your problems when you use the camera. Please fax or email this form to the dealer/distributor from which you purchased the product.

SENDER:

FIRM:

TEL:

MAIL:

	Operating System (E.g. Win 7, XP):
Which Camera are you using?	Type (e.g.: sv3625MTHCPC):
	Serial Number:
Which Accessories are you using?	Power Supply:
	Cable:
	Lens Type and Focal Length:
Firmware	No. of Version:
	Operation Mode:
	Please send a screenshot of "ConvCam" screen or log file.
In case of EURESYS Grabber:	Brand and Type:
	Driver Version:
	If Patch please specify:
	Camera file used:
Short Description of Problem	(E.g. missing lines, noisy image, missing bits etc.):

Space for further descriptions, screenshots and log-files

11 IP protection classes

There is a classification system regarding the kind of environment influences which might do harm to your product. These are called IP Protection Classes and consist of the letters „IP“ followed by two numbers.

First Digit	Second Digit	Brief description	Definition
0		Not protected	-
1		Protected against solid foreign objects, 50 mm and larger	A probing object, a ball of 50mm in diameter, must not enter or penetrate the enclosure
2		Protected against solid foreign objects, 12.5 mm and larger	A probing object, a ball of 12.5mm in diameter, must not enter or penetrate the enclosure
3		Protected against solid foreign objects, 2.5 mm and larger	A probing object, a ball of 2.5mm in diameter, must not penetrate at all
4		Protected against solid foreign objects, 1.0 mm and larger	A probing object, a ball of 1mm in diameter, must not penetrate at all
5		Protected against dust	The ingress of dust is not completely prevented. The quantity of dust that enters not impair the safety or satisfactory operation of the equipment
6		Dustproof	No ingress of dust
	0	Not protected against liquids	-
	1	Protected against water droplets	Vertically falling droplets must not have any harmful effect when the enclosure is at an angle of 15° either side of the vertical
	2	Protected against water droplets	Droplets falling vertically must not have any harmful effect with enclosure at an angle of 15° either side of the vertical
	3	Protected against spray water	Water sprayed at any angle of up to 60° either side of the vertical must not have any harmful effect
	4	Protected against water splashes	Water splashing against the enclosure from any angle must not have any harmful effect
	5	Protected against water jets	Water jets directed at the enclosure from any angle must not have any harmful effect
	6	Protected against powerful water jets	Powerful water jets directed against the enclosure from any angle must not have any harmful effect
	7	Protected against the effect of brief submersion in water	Water must not enter the equipment in amounts that can have a harmful effect if the enclosure is briefly submerged in water under standardised pressure and time conditions
	8	Protected against the effect of continuous submersion in water	Water must not enter the equipment in amounts that can have a harmful effect if the enclosure is continuously submerged in water. The conditions must be agreed between the manufacturer and the user. The conditions must, however, be more severe than code 7
	9K	Protected against water from high- pressure and steam jet cleaning	Water directed at the enclosure from any angle under high pressure must not have any harmful effect

12 Glossary of Terms

Aberration	Spherical aberration occurs when light rays enter near the edge of the lens; Chromatic aberration is caused by different refractive indexes of different wavelengths of the light. (Blue is more refractive than red)
ADC	Analogue-to-Digital Converter, also known as A/D converter
Aperture	In optics, Aperture defines a hole or an opening through which light travels. In optical system the Aperture determines the cone angle of a bundle of rays that come to a focus in the image plane. The Aperture can be limited by an iris, but it is not solely reliant on the iris. The diameter of the lens has a larger influence on the capability of the optical system.
Bayer Pattern	A Bayer filter mosaic or pattern is a color filter array (CFA) deposited onto the surface of a CCD or CMOS sensor for capturing RGB color images. The filter mosaic has a defined sequence of red, green and blue pixels such that the captured image can be transported as a monochrome image to the host (using less bandwidth); where after the RGB information is recombined in a computer algorithm.
Binning	Binning combines the charge from two (or more) pixels to achieve higher dynamics while sacrificing resolution.
Bit-Depth	Bit-depth is the number of digital bits available at the output of the Analog-to-Digital Converter (ADC) indicating the distribution of the darkest to the brightest value of a single pixel.
Camera Link	Camera Link is a multiple-pair serial communication protocol standard [1] designed for computer vision applications based on the National Semiconductor interface Channel-link. It was designed for the purpose of standardizing scientific and industrial video products including cameras, cables and frame grabbers.
CCD	Charge Coupled Device. Commonly used technology used for camera sensors used to detect & quantify light, i.e. for capturing images in an electronic manner. CCDs were first introduced in the early 70ies.
CMOS	Complementary Metal–Oxide–Semiconductor. A more recently adopted technology used for camera sensors with in-pixel amplifiers used to detect & quantify light, i.e. capturing images in an electronic manner.
CPU	Central Processing Unit of a computer. Also referred to as the processor chip.
dB	Decibel (dB) is a logarithmic unit used to express the ratio between two values of a physical quantity.
Decimation	For reducing width or height of an image, decimation can be used (CMOS sensors only). Columns or rows can be ignored. Image readout time is thereby reduced.
Defect map	Identifies the location of defect pixels unique for every sensor. A factory generated defect map is delivered and implemented with each camera.
EPROM	Erasable Programmable Read Only Memory is a type of memory chip that retains its data when its power supply is switched off.
External Trigger	Erasable Programmable Read Only Memory is a type of memory chip that retains its data when its power supply is switched off.
fixed frequency	or programmed exposure time. Frames are read out continuously.
Gain	In electronics, gain is a measure of the ability of a two-port circuit (often an amplifier) to increase the power or amplitude of a signal from the input to the output port by adding energy to the signal.

Gamma	Gamma correction is a nonlinear operation used to code and decode luminance values in video or still image systems.
GenICam	Provides a generic programming interface for all kinds of cameras and devices. Regardless what interface technology is used (GigE Vision, USB3 Vision, CoaXPress, Camera Link, etc.) or which features are implemented, the application programming interface (API) will always be the same.
GigE Vision	GigE Vision is an interface standard introduced in 2006 for high-performance industrial cameras. It provides a framework for transmitting high-speed video and related control data over Gigabit Ethernet networks.
GPU	Graphics Processing Unit of a computer.
Hirose	Cable connectors commonly used for power, triggers, I/Os and strobe lights
ISO	see Gain.
Jumbo Frames	In computer networking, jumbo frames are Ethernet frames with more than 1500 bytes of payload. Conventionally, jumbo frames can carry up to 9000 bytes of payload. Some Gigabit Ethernet switches and Gigabit Ethernet network interface cards do not support jumbo frames.
Mount	Mechanical interface/connection for attaching lenses to the camera.
Multicast	Multicast (one-to-many or many-to-many distribution) is an ethernet group communication where information is addressed to a group of destination computers simultaneously. Multicast should not be confused with physical layer point-to-multipoint communication.
PWM	Pulse width modulation. Keeping voltage at the same level while limiting current flow by switching on an off at a very high frequency.
Partial Scan	A method for reading out fewer lines from the sensor, but “skipping” lines above and below the desired area. Typically applied to CCD sensors. In most CMOS image sensors an AOI (area of interest) or ROI (region of interest) can be defined by selecting the area to be read. This leads to increased frame rate.
Pixel clock	The base clock (beat) that operates the sensor chip is. It is typically also the clock with which pixels are presented at the output node of the image sensor.
RAW	A camera RAW image file contains minimally processed data from the image sensor. It is referred as raw in its meaning. SVS-VISTEK plays out RAW only.
Read-Out-Control	Read-Out control defines a delay between exposure and image readout. It allows the user to program a delay value (time) for the readout from the sensor. It is useful for preventing CPU overload when handling very large images or managing several cameras on a limited Ethernet connection.
Shading	Shading manifests itself a decreasing brightness towards the edges of the image or a brightness variation from one side of the image to the other. Shading can be caused by non-uniform illumination, non-uniform camera sensitivity, vignetting of the lens, or even dirt and dust on glass surfaces (lens).
Shading correction	An in-camera algorithm for real time correction of shading. It typically permits user configuration. By pointing at a known uniform evenly illuminated surface it allows the microprocessor in the camera to create a correction definition, subsequently applied to the image during readout.
Shutter	Shutter is a device or technique that allows light to pass for a determined period of time, exposing photographic film or a light-sensitive electronic sensor to light in order to capture a permanent image of a scene.

Strobe light	<p>A bright light source with a very short light pulse. Ideal for use with industrial cameras, e.g. for “freezing” the image capture of fast moving objects. Can often be a substitute for the electronic shutter of the image sensor. Certain industrial cameras have dedicated in-camera output drivers for precisely controlling one or more strobe lights.</p>
Tap	<p>CCD sensors can occur divided into two, four or more regions to double/quadruple the read out time.</p>
TCP/IP	<p>TCP/IP provides end-to-end connectivity specifying how data should be packetized, addressed, transmitted, routed and received at the destination.</p>
USB3 Vision	<p>The USB3 Vision interface is based on the standard USB 3.0 interface and uses USB 3.0 ports. Components from different manufacturers will easily communicate with each other.</p>
Trigger modes	<p>Cameras for industrial use usually provide a set of different trigger modes with which they can be operated.</p> <p>The most common trigger modes are: (1) Programmable shutter trigger mode. Each image is captured with a pre-defined shutter time; (2) Pulse-Width Control trigger. The image capture is initiated by the leading edge of the trigger pulse and the shutter time is governed by the width of the pulse; (3) Internal trigger or Free-Running mode. The camera captures images at the fastest possible frame rate permitted by the readout time.</p>
XML Files	<p>Extensible Markup Language (XML) is a markup language that defines a set of rules for encoding documents in a format which is both human-readable and machine-readable</p>

13 Index of figures

FIGURE 1: TABLE OF SAFETY MESSAGES	5
Figure 1: Illustration of 4IO concept of switching LEDs.....	9
Figure 3: Screenshot of SVCapture 2.x	11
Figure 4: basic Illustration of driver circuit.....	18
Figure 5: Illustration of Hirose 12 Pin & pin-out (HR10A-10R-12PB).....	20
Figure 6: Illustration of C- & CS-Mount differences.....	25
Figure 7: Illustration Cross-section of a CCD sensor from Sony	26
Figure 8: Illustration of interline transfer with columns and rows	27
Figure 1: Rolling shutter with fast moving object details	28
Figure 10: motion blur	28
Figure 11 rolling shutter with moving objects.....	28
Figure 12: interlaced effect	28
Figure 1: illustration of rising amount of values/gray scales by increasing the bit format	31
Figure 3: Simplified illustration of a quantification graph	31
Figure 15: illustration of shade difference in 8 bit format.....	31
As shown in figure 16 differences in shades of gray are hardly visible on screen or in print.	31
Figure 17: Figure of original picture - black & white	32
Figure 18: Figure of quantification with 6 shades of gray (reduced colour depth).....	32
Figure 1: CCD with Bayer Pattern.....	33
Figure 20: Table of color temperatures.....	33
Figure 21: Illustration of active and effective sensor pixels	34
Figure 22: Illustration of dark noise cut off by the offset.....	35
Figure 23: Table of dB and corresponding ISO	36
Figure 24: noise caused by increasing gain excessively	36
Figure 25: Figure of original image.....	37
Figure 26: Figure of image horizontally flipped.....	37
Figure 27: Figure of image vertically flipped.....	37
Figure 28: Illustration of vertical binning	38
Figure 29: Illustration of horizontal binning	38
Figure 30: Illustration of 2x2 binning.....	39
Figure 31 Horizontal decimation Figure 32 Vertical decimation	39
Figure 33: Illustration of decimation on color sensors	39
Figure 1: table of tap geometry/configurations.....	41
Figure 35: Illustrations of the nomenclature used in specifications.....	41
Figure 36: Figure of 1 Tap.....	42

Figure 37: Illustration of 1 tap.....	42
Figure 38: Figure of 2 taps.....	42
Figure 39: Illustration of 2 taps	42
Figure 1: Figure of an unbalanced 2 tap image	42
Figure 41: illustration of a custom LUT adding contrast to the midtones	48
Figure 42: illustration of several gamma curves comparable to a LUT ..	49
Figure 43: Illustration of AOI limitation on a CCD sensor	50
Figure 44: "IN0" connected to "debouncer"	50
Figure 4: illustration of the backside view of the camera modules. The side of the switch matrix. connections will be made with a "1" instead of a "0"	52
Figure 5: illustration of frontside view to the camera modules.	53
Figure 47: Illustration of four LEDs switched internal by the camera.....	57
Figure 48: Illustration of conventional schematic electric circuit	58
Figure 49: pulseloop for strobe and exposure	60
Figure 50: pulseloop – activating three cameras	60
Figure 9: Illustration of an application using the 4IO	63
Figure 52: illustration of three sequencer intervals	65
Figure 53: 25 % intensity	67
Figure 54: 50 % intensity	67
Figure 55: 75 % intensity.....	67
Figure 56: UART encoding of a data stream	72
Figure 57: LVDS signal – no return to zero volt.....	72
Figure 58: illustration of schmitt trigger noise suspension - high to low I low to high.....	73
Figure 59: bounces or glitches caused by a switch during 300 μ s	73
Figure 60: block diagram – debouncer in between the trigger source and the trigger	74
Figure 61: Illustration of the debouncer module	74
Figure 62: illustration of prescale values	75
Figure 63: Illustration of the prescale module.....	75
Figure 1: ECO standard & ECO Blackline with IR cut filter	76
Figure 65: Diagram of light transmission – IR cut filter	77
Figure 66: IMX694LQR.....	81
Figure 67: IMX694LLR	81
Figure 68: IMX695LQR.....	84
Figure 69: IMX695LLR	84
Figure 70: IMX814LQR.....	87
Figure 71: IMX814LLR	87
Figure 72: IMX815LQR.....	90

Figure 73: IMX815LLR 90
Figure 74: IMX834LQR 93
Figure 75: IMX834LLR 93

14 Index

- 2×2 Binning 38
- 4 IO high voltage drain 57
- 4IO adds Light and Functionality 9
- Acquisition and Processing Time 29
- ADC 36, 42
- AND 69
- AOI 50
- AR filter 76
- Assigning I/O Lines – IOMUX 50
- Auto Gain 36
- Auto Luminance 30
- Automatic Tap Balancing 43
- Back 23
- Balancing 42
- Basic Capture Modes 45
- Basic Understanding 26
- Basic Understanding of CCD Technology 26
- Binning 38
- Bit-Depth 31
- Boolean 69
- Bottom 23
- Bounces 73
- Building blocks simplify design-in 7
- Burst Mode 39
- C & CS Mount 25
- Camera Features 41
- CCD 26, 35, 38, 42, 50
- Clock 44
- Color 33, 39
- Connectors 19
- Continuously Tap Balancing 43
- ConvCam 97
- Cross Section 24
- Cycle duration 66
- dark noise 35
- dB 36
- debouncer 50, 74
- Debouncing 73
- Debouncing Trigger Signals 73
- Decimation 39
- Decimation on Color Sensors 39
- Detailed Info of External Trigger Mode 46
- differential low voltage 72
- Dimensions 21
- Diode characteristic 66
- Driver Circuit Schematics 18
- Dual-Tap 42
- duty cycle 66
- duty ratio 66
- EPROM 50
- Europe 6
- Example of an IOMUX configuration 56
- Example: 65
- Exclusive body architecture 7
- EXO694*U3 79
- exo694*U3, exo814*U3, exo834*U3 21
- EXO695*U3 82
- EXO814*U3 85
- EXO815*U3 88
- EXO834*U3 91
- Exposure 30, 45, 64
- Exposure Delay 62
- External Trigger (Exposure Time) 46
- FAQ 96

- Feature-Set 26
- Filter 76
- Firmware update 17
- fixed frequency 45, 66
- Flip 37
- Focal Impact of Filters 77
- Frames per Second 29
- Free Running 45
- front 21
- FVAL 45
- Gain 36
- galvanical 67
- Gamma 49
- Gamma Correction 49
- Getting Started 10
- Global Shutter / Progressive Scan 28
- Glossary of Terms 101
- Horizontal Binning 38
- I/O 50
- I/O Features 50
- illumination 66
- Image Flip 37
- Image Impact of IR Cut Filter 77
- Implementation of PWM 66
- Index of figures 104
- Initialization 15
- Input / output connectors 20
- input vector to switch matrix 54
- Installation 12
- Interline Transfer 27
- interval 64
- Inverter 56
- Inverter & Set-to-1 56
- IO Assignment 73
- IP protection classes 99
- IR cut filter 33, 76
- ISO 36
- Kelvin 33
- LED 44
- LED Codes 10
- LEDs 66
- LEDs in Flash Mode 62
- Legal Information 6
- Light sources 33
- light transmission 77
- Limitation 30
- log file 97
- LookUp Table 48
- Luminance 30
- LUT 48
- LVAL 45
- LVDS 72
- Manual Tap Balancing 43
- MHz 44
- Modulation frequency 66
- NAND 69
- no return to zero volt 72
- noise 35
- NOR 70
- of IR Cut Filter 77
- Offset 35
- Optical Input 67
- OR 70
- output vector from switch matrix 55
- PLC/Logical Operation on Inputs 69
- Power supply 10
- Prescale 75
- pulse width modulation 57, 66
- pulseloop 66
- PWM 66
- raw 33
- readout 45
- reference of time 44
- Resolution 34, 38

- Resolution – active & effective 34
- ROI 50
- ROI / AOI 50
- RS-232 70, 71
- RS-422 70, 72
- RXD 71
- Safety Messages 5
- schmitt trigger 73
- Sequencer 64, 66
- Serial data interfaces 70
- Setting Exposure time 30
- settings 64
- Set-to-1 56
- Shock & Vibration Resistance 6
- side Left 21
- Side Right 22
- Single-Tap 41
- Software 11
- Software Trigger 47
- Space for further descriptions, screenshots and log-files 98
- Specifications 78
- Spectral Impact of IR Cut Filters 77
- Standard Tap Geometries 41
- Strobe 50
- Strobe Control 57
- Strobe Control Example Setup 63
- Strobe Delay 62
- Strobe Duration 62
- Strobe Polarity 62
- Strobe Timing 62
- Support Request Form 97
- Support Request Form / Check List 97
- SVCapture 2.x 11
- System Clock Frequency 44
- Tap 42
- Tap Balancing 42
- Tap Balancing once 43
- Tap configuration 41
- Tap Reconstruction on USB3 Vision 42
- Tap Structure 41
- temperature 35, 44
- Temperature Sensor 44
- temperatures 33
- Terms of warranty 94
- The Debouncer module 74
- The EXO 7
- The EXO with USB3 Vision 7
- The prescale module 75
- The pulseloop module 60
- Top 22
- trigger 45, 46, 47, 50, 73
- Triggered Mode (pulse width) 45
- Trigger-Edge Sensitivity 73
- Troubleshooting 96
- TXD 71
- UART 72
- USA and Canada 6
- Usage of Burst Mode 40
- USB 3.0 driver 17
- USB Flashing LED Codes 10
- USB3 Vision 19
- Vertical Binning 38
- Warranty 94
- WARRANTY 6, 94
- White Balance 33
- Why PWM? 66