

# USERS MANUAL

## SVCam "HR" series

svs11002, svs16000, hr16050, hr16070,  
and hr29050

## Gigabit Ethernet "GigE" Line



**GiGE**<sup>™</sup>  
VISION

GEN<i>CAM

Digital Progressive Area Scan Camera

Rev 23

Last Update 26th of February 2014

## **Contact:**

### **SVS-VISTEK GmbH**

Mühlbachstraße 20  
82229 Seefeld/Obb., Germany

Tel. +49-(0)8152-99 85-0  
Fax. +49-(0)8152-99 85-79

[www.svs-vistek.com](http://www.svs-vistek.com)

### **For For USA and Canada :**

### **SVS-VISTEK Inc.**

5737 Ridge Creek Road  
Shoreview, MN 55126, USA

Tel: 651.756.8632  
Fax: 651.756.7481

E-Mail [info-us@svs-vistek.com](mailto:info-us@svs-vistek.com)

### **For Asia and Pacific Region :**

### **SVS-VISTEK KK.**

1-17-10 Hashido, Seya-ku, Yokohama  
246-0037 Kanagawa, Japan

Tel. +81 80 55200854

E-Mail [info-asia@svs-vistek.com](mailto:info-asia@svs-vistek.com)

## **Support contact:**

E-Mail: [support@svs-vistek.com](mailto:support@svs-vistek.com)

## Index

### Content

1	Introduction .....	6
2	Pinout and Installation .....	7
	<b>2.1</b> Unpacking .....	7
	<b>2.2</b> Power supply .....	7
	<b>2.3</b> Connector <b>See outline and notes in chapter 13.4.3</b> .....	7
	<b>2.4</b> “Ethernet” Connector .....	8
	<b>2.5</b> Installation/Getting started .....	8
	<b>2.6</b> Hardware .....	8
	<b>2.7</b> Available operation modes .....	9
	2.7.1    Operation Modes .....	9
	<b>2.8</b> LED Signals SVCam- .....	10
	Camera status .....	10
	<b>2.9</b> Temperature Sensor.....	10
3	Software SVCapture/GigE Vision Camera Viewer.....	11
	<b>3.1</b> Overview .....	11
	<b>3.2</b> Adjusting TCP/IP resp. network settings.....	11
	<b>3.3</b> Adjusting TCP/IP resp. network settings <b>Fehler! Textmarke nicht definiert.</b>	
	3.3.1    Network address assignment.....	12
	3.3.2    Persistent Network address assignment .....	14
	3.3.3    Using jumbo frames.....	14
	3.3.4    Performance considerations.....	15
	3.3.5    Connecting multiple cameras to a PC ONLY if 1 GigE output (out of	
	2) is used ! .....	16
	Using Dual GigE channels (2 cables) with a Switch is NOT supported .....	16
	3.3.6    Multicast ONLY if 1 GigE output (out of 2) is used !.....	17
	3.3.7    Displaying live images .....	18
4	Camera settings dialog .....	20
	4.1.1    Camera .....	21
	<b>4.2</b> Network .....	21
	<b>4.3</b> Acquisition.....	21
	<b>4.4</b> Image .....	22
	<b>4.5</b> Gain .....	23
	4.5.1    Offset .....	23
	<b>4.6</b> AutoGain/AutoExposure / <b>Planned</b> .....	24
	<b>4.7</b> Tap configuration.....	24
	<b>4.8</b> Auto tap balance .....	24
	<b>4.9</b> Image Flip .....	26
	<b>4.10</b> Adjusting an AOI (area of interest) .....	26
	<b>4.11</b> Strobe.....	26
	<b>4.12</b> Persistence .....	26
5	Saving images to disk.....	27
6	Flat Field and Shading Correction .....	28
7	Assigning IO lines .....	30
8	Displaying a camera’s XML file .....	32
9	Displaying a camera’s feature list .....	33
10	Other menu items .....	33
11	Context menu.....	34
12	Firmware update.....	35
13	TECHNICAL DATA.....	36
	<b>13.1</b> CCD used/cosmetic issues: .....	36
	13.1.1    Sensors:.....	36

13.1.2	Cosmetic Specs .....	36
13.1.3	Pixel Defect Correction .....	37
13.1.4	Spectral range.....	37
<b>13.2</b>	Gain balancing (in case of 11 and 16 MP "F" + "U" version and if set to 2 tap /"L" version) .....	38
13.2.1	Sensor/ADC settings for tap balancing . DUAL tap cameras .....	39
<b>13.3</b>	Signal conditioning .....	40
<b>13.4</b>	Optical and mechanical issues .....	40
13.4.1	Tripot Mount .....	41
13.4.2	Views on front, rear and side.....	41
13.4.3	Connectors .....	42
	HR10A-10R-12PB (mating connector HR10A-10P-12S) .....	43
<b>13.5</b>	Basic electro-optic specifications svs11002 "S" version/12 Bit Output .....	43
<b>13.6</b>	Basic electro-optic specifications svs11002 "F" version/12 Bit Output .....	44
<b>13.7</b>	Basic electro-optic specifications svs11002 "U" version/12 Bit Output .....	44
13.7.1	Basic electro-optic specifications svs16000 "F" version/12 Bit Output .....	45
13.7.2	Basic electro-optic specifications svs16050 .....	45
13.7.3	Basic electro-optic specifications svs16070 .....	45
<b>13.8</b>	Basic electro-optic specifications svs16000 "U" version/12 Bit Output .....	46
<b>13.9</b>	Basic electro-optic specifications svs29050 .....	46
<b>13.10</b>	Environmental Issues: .....	47
13.10.1	Europe .....	47
13.10.2	USA and Canada.....	47
<b>13.11</b>	Spectral response curves .....	48
13.11.1	Comments on camera temperature .....	49
13.11.2	White Balance .....	49
<b>13.12</b>	Comments on COLOR Version.....	50
14	Appendix A – Troubleshooting.....	52
<b>14.1</b>	Problem: A camera does not appear in the discovery dialog .....	53
<b>14.2</b>	Problem: Camera image .....	53
<b>14.3</b>	TROUBLESHOOTING REQUEST LIST V1.3 .....	54
15	Appendix A – Basic timing for different operation modes.....	55
<b>15.1</b>	Free running .....	55
<b>15.2</b>	External Trigger and Pulswidth of Trigger.....	55
<b>15.3</b>	External and Software trigger and internal exposure time setting .....	55
16	Appendix B .....	56
•	Automated SVGigE Filter Driver installation.....	56
•	Automated SVGigE Filter Driver de-installation .....	57
	Manual SVGigE FilterDriver installation .....	59
<b>16.1</b>	Installation Instruction for Filter Driver installation .....	59
<b>16.2</b>	Step-by-step.....	59
17	Appendix C .....	64
	Setting Static Link Agregation (SLG) on Intel Pro 1000 Dual port NIC card .....	64
	Choose static Link Agregation .....	66
	Press finish .....	67
	Adapter teaming is done .....	67
18	Appendix D .....	71
<b>18.1</b>	PC and OS Requirements .....	71
18.1.1	Firewall considerations .....	71
19	Appendix E.....	72
<b>19.1</b>	Firmware-Update with "GigE Update Tool.exe" program .....	72
20	Appendix F.....	74

Basic circuits for Hardware Interfacing .....	74
<b>20.1</b> For svs11002 and svs16000 .....	74
TTL input circuit .....	74
TTL output circuit .....	74
<b>20.2</b> For hr16050, hr16070 and hr29050.....	75
<b>20.3</b> Safety Instructions.....	76

# 1 Introduction

Thank you for purchasing a SVS-VISTEK product. SVS-VISTEK stands for reliable competence and customer oriented solutions in the field of professional machine vision systems. We believe that we are more than just a trade partner of machine vision components and we believe in sharing our years of development expertise with our customers. We offer single source solutions and are a one-stop shopping center for all questions concerning professional machine vision. As a consequence, our insistence on the highest quality has resulted in many companies worldwide that use our products and services with great success and satisfaction. Customers at home and abroad trust and rely on our know-how and experience.

The **SVCam HR-Line** cameras offer HIGHEST RESOLUTION with one shot, combined with digital output (non interlaced, progressive scan cameras) via Ethernet technology. Further, they feature an excellent S/N ratio at low prices.

The exposure time can be adjusted in different ways. 4 operation modes are available to cover most applications in image processing and optical metrology.

The following types are covered in this manual:

svs11002 43.3mm diagonal CCD, 4008 x 2672 pixel, 12 Bit gray level resolution, up to 6.2 frames/sec. Monochrome and color version **(using electrical 14 Bit ADC)**.

svs16000 43.3mm diagonal CCD, 4872 x 3248 pixel, 12 Bit gray level resolution, up to 4.7 frames/sec . Monochrome and color version **(using electrical 14 Bit ADC)**.

hr16050 32,36mm diagonal CCD, 4872 x 3248 pixel, 12 Bit gray level resolution, up to 10 frames/sec . Monochrome and color version **(using electrical 14 Bit ADC)**.

hr16070 43,3mm diagonal CCD, 4872 x 3248 pixel, 12 Bit gray level resolution, up to 11 frames/sec . Monochrome and color version **(using electrical 14 Bit ADC)**.

hr29050 43.47mm diagonal CCD, 6576 x 4384 12 Bit gray level resolution, up to 6.2 frames/sec . Monochrome and color version **(using electrical 14 Bit ADC)**.

**For standard applications it is recommended to use only 8 Bit due to data load**

**For more information on the color versions, please see chapter 4.9.**

If you need modifications, we will be glad to offer you a custom camera suitable to your application.

## 2 Pinout and Installation



### Warning

The CCD camera is built with CMOS-LSI circuits. All internal electronics in the camera are sensitive to high voltage or electrostatic discharge. The camera can be destroyed if carelessly handled, so extreme care should be taken during set up and operation. Do not expose the sensor to a direct laser beam as this could damage the sensor! See Safety Instructions at the end of the manual. Warranty will be void if not followed.

### 2.1 Unpacking

- Camera
- Power supply (if ordered/option)
- User Manual
- SDK/API user guide
- Disk with SDK including "Filter Driver", API and GUI "SVCapture" (for GigE camera) program. **Also a Firmware update tool.**
- XML File according to **GenIcam** standard released by AIA committee.

### 2.2 Power supply

Power consumption:



svs11002 = **7 W(typical)**  
 svs16000 = **7W(typical)**  
 hr16050 = **10 W(typical)**  
 hr16070 = **10 W(typical)**  
 hr29050 = **10 W(typical)**

**Peak current on "Power on" up to 2 Ampere!**

### 2.3 Connector **See outline and notes in chapter 13.4.3**

#### HR10A-10P-12PB (mating connector HR10A-10P-12S)

- 1 VIN- (GND)
- 2 VIN+ (10 to 25VDC)
- 3 RXD data to camera (RS232 Level)
- 4 TXD data from camera (RS232 Level)
- 5 IN1 (TTL Level)
- 6 IN2 (TTL Level)
- 7 OUT1 (TTL Level)
- 8 OUT2 (TTL Level)
- 9 IN3+, 10 IN3- (RS422 Level)
- 11 OUT3+, 2 OUT3- (RS422 Level)

## 2.4 "Ethernet" Connector

RJ 45 "Western" Connector complies with Autosensing 10/100 T Ethernet and Gigabit specification. Features Auto MDIX.

2 LEDs:

- Green = Traffic(busy)
- Yellow: Link (connection established)

## 2.5 Installation/Getting started

### Recommended PC

It is recommended to use a PC with a Pentium i7 processor. The camera is working also on lower frequencies but it might not deliver the full framerate in those cases.



**For svS11002 and higher it is recommended to use a 4 core CPU (i5/i7) with minimum of 4 Gbyte RAM.**

If the camera is connected to the PC directly without using a network switch, **a fixed IP-Address and Subnet-Mask has to be configured in the PC's TCP/IP settings:**

See: Start->Settings->Network connections->LAN-connection->Properties->TCP/IP

**For hr16050, hr16070 and hr29050 with 2 ports connected: The IP address must be configured following the "Static LINK AGREGATION" (SLA) standard. If not done, performance is reduced. See Appendix in order to create the "Teaming" of 2 ports.**

A Gigabit Ethernet network adapter is needed (100 Mbit adapters would also sometimes work, but with insufficient framerates). If your PC does not have a Gigabit interface card purchase a card **using an original INTEL(TM) Chip set.**



**We don't recommend to use any "On Board" chip sets, due to potential bandwidth issues.**

## 2.6 Hardware



Install camera in the desired location. You can use the ¼" tripod adapter or use the 4 M3 holes in the adapter of the camera. Connect the power supply. If you have ordered a P/S connect it to the camera. If you use your own power supply (must be between 9 and 25 VDC) make See Chapter 5.4.3. If you – by mistake – supply line with GND pin the camera can be damaged!

**If power supply was ordered, do not modify it.**

Connect one or 2 Ethernet cable to your PC or a network switch like you would built up a PC Network. Please note that cable length should not exceed 100m for theses camera (Cat 5E version). In doubt consult your local distributor!





**For hr16050/70 hr svs2950: If you want to use the full frame rate connect 2 cables to a dual port NIC card. If only one port is connected, use the **RIGHT one** !**

Wait 15 seconds until the green LED at the RJ45 connector of the Camera blinks sometimes.

Then start "SVCapture.exe".

## 2.7 Available operation modes



### **General:**

**All modes are set by the interface which connects via ETHERNET standard cable.**

**CAT 5E quality is required.**

The default factory setting is **free running/fixed frequency** using the internal logic for exposure control You can also trigger the camera by hardware and by PC (Software trigger).

The color version will come on request with free software algorithm which will allow processing of the color image inside the PC or the camera. This must to be done in order to interpolate the colors for each pixel. Please note that no responsibility can be taken for the algorithm. It might be necessary to change the algorithm according to the application. **See chapter 4.9.**

### 2.7.1 Operation Modes

- **Fixed frequency (Free running)**  
The camera puts out data automatically. The framerate can be adjusted.
- **Triggered, external exposure control**  
If you want to trigger the camera and determine the exposure time by the pulse width, choose this mode. Then apply a TRIGGER signal at the appropriate pins e.g. on pins of Hirose connector (see Layout for Connector. With the starting edge of the pulse the camera will start exposure time. The exposure time ends with next upcoming edge of the trigger signal. Please check the timing diagram in the appendix of this manual.
- **External triggered, internal camera exposure control**  
If you want to trigger the camera and use the convenient exposure time control of the micro controller then use this mode. You still can use the SVCapture GUI for setting exposure time (see "Exposure time"-field below). However you need to use the trigger signal in order to trigger the camera (see "Trigger"-buttons below).
- **External triggered via Software trigger with internal exposure control**  
If you want to trigger the camera with a software trigger and use the SVCapture exposure time control of camera logic, then use this mode.

## 2.8 LED Signals SVCam-

### Camera status

Signals:

- No connection with network cable (yellow slow)
- Assignment of the network address (yellow fast)
- Network address assigned (yellow)
- Connected with application (green)
- Streaming channel available (green slow)
- Acquisition enabled (green fast)
- Problem with initialization (red slow)
- Overheating (red fast)

Optional instead of "acquisition enabled":

- Waiting for trigger (blue)
- Exposure active (cyan)
- Readout/FVAL (violet)

### Code signals

ON

Slow (ca 1 Hz)

Fast (8 Hz)

## 2.9 Temperature Sensor

There is a temperature sensor installed close to the CCD. It is possible to read out and monitor the temperature to check a possible overheating.

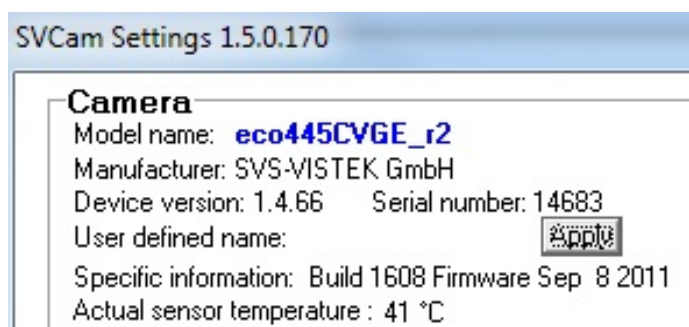

This sensor is also used to indicate heat problems causing the LED flashing red (fast). See previous section.

## 3 Software SVCapture/GigE Vision Camera Viewer

### 3.1 Overview

You can use the SVCapture without the "Filter Driver" but if you want avoid a loss of data and lower the CPU load when grabbing images, **install it now. SEE APPENDIX "B"**



**You will observe a loss of frames if you don't use the driver**

If you have installed the camera and connected power, you can install **SVCapture.exe and the DRIVER** to do the first test. Double click on the SVCapture icon and a window will open.

The Software "SVCapture" displays images sent from SVS GigE-Cameras via Gigabit Ethernet to your PC (with Windows XP or Win 7) and it allows for adjusting basic camera settings. **For Linux users: Create your own GUI, please.**

### 3.2 Adjusting TCP/IP resp. network settings

If the live image is not displayed as shown before, this is most often caused by inappropriate network settings. In this case the camera's network settings have to be adjusted first before getting it into an operational mode.

Adjust settings accordingly

Settings->Network connections->LAN-connection->Properties->TCP/IP

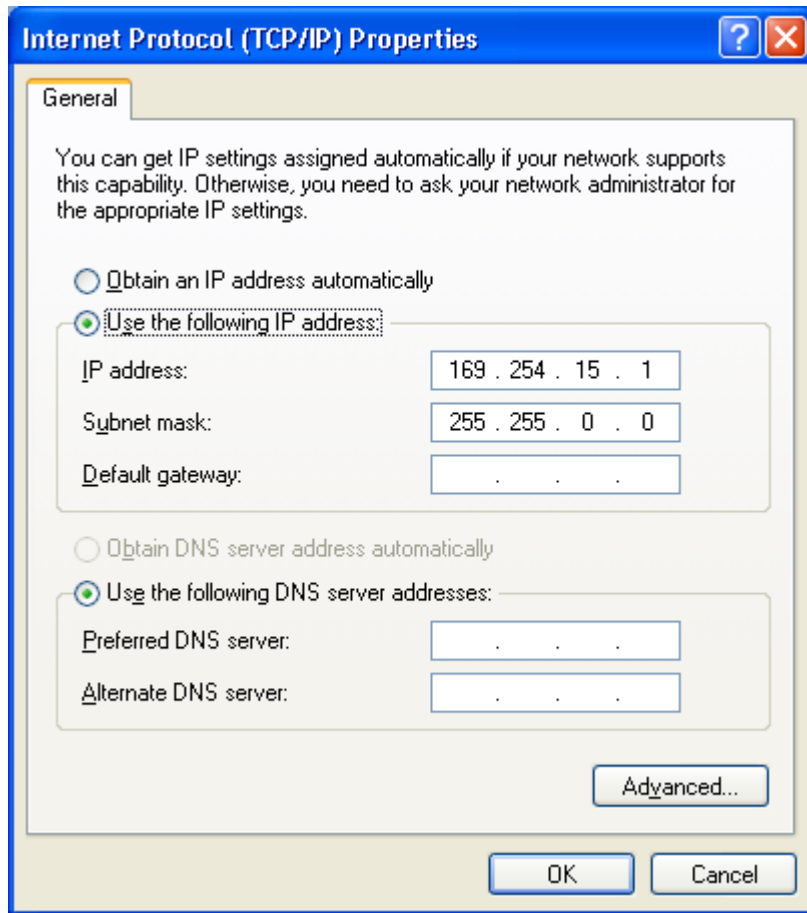

In a network with a DHCP server the camera will obtain its IP address automatically and the settings shown in the screenshot above will be on “Obtain an IP address automatically.”

### 3.2.1 Network address assignment

The main components of a network address are the IP (Internet Protocol) address and the network mask. The usually applied network mask “255.255.255.0” for small networks up to 254 PCs represents a 32 Bit long bit mask where the first 24 bits are set to 1 and the last 8 bits are set to 0. This network mask instructs the network hardware to let those devices exchange information with each other where the first 24 bits of the IP addresses match for all devices.

Thus the variable range of addresses is made from all possible combinations of the last 8 bits for which the network mask is set to 0. Exceptions are the first address 0 and the last address 255 which have special meanings for network management functions. All other 254 combinations are usually free for assigning them to network devices.

For a peer-to-peer connection of a GigE camera to a PC a network address assignment based on LLA (Local Link Address) is recommended. This involves a network mask “255.255.0.0” as well as a fixed first part “169.254.xxx.xxx” of the network address range. A GigE camera will fall back to LLA soon after recognizing that no DHCP server is available and that no fixed network address was assigned to the camera.

In case a camera can not be reached by the SVCapture application a dialog will appear that allows for adjusting a camera’s network parameters. The simplest way is to click

on "Automatic" which will provide to a search for a free IP address and to assigning it to the camera given that the interface IP could be determined properly.

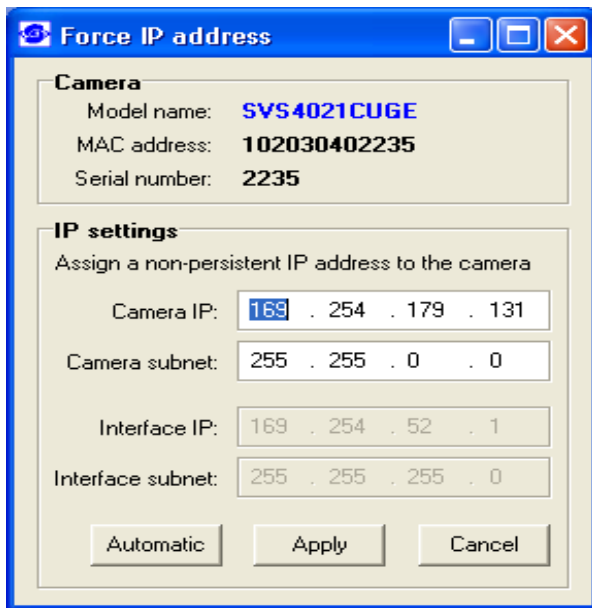

That dialog can also be brought up when right clicking on an entry in the discover dialog and subsequently selecting "Force IP address" in the context menu. However, when adjusting the PC network settings to LLA the camera must not get assigned a fixed network address

**NOTE:** The network settings performed in the "Force IP address" dialog are only valid until the next shutdown and restart of a camera. For permanently changing a camera's network settings the "Network settings" dialog can be used instead. That dialog can also be opened in the context menu which is displayed when right-clicking on an entry in the discover dialog.

### 3.2.2 Persistent Network address assignment

Open the dialog by selecting “Network settings” in the context menu that comes up when right-clicking on an entry in the discovery dialog:

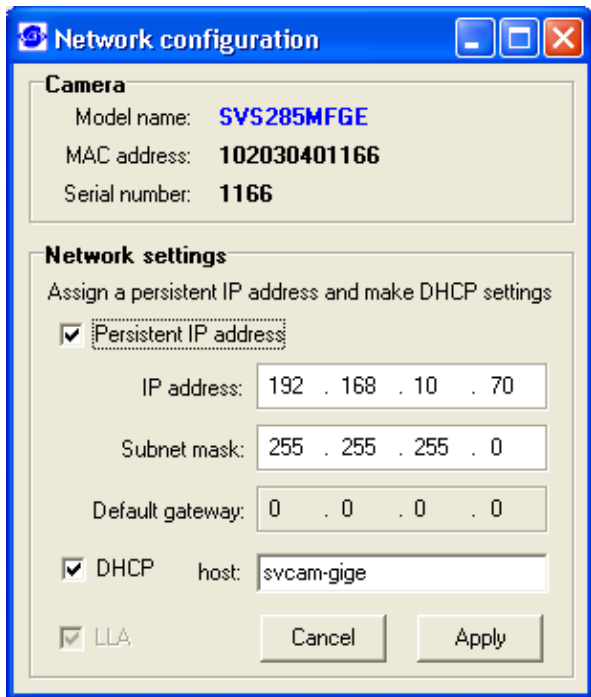

All settings in the “Network configuration” dialog will be transferred to the camera and they will be made persistent on the EEPROM inside the camera. Therefore this dialog allows for assigning a non-volatile network address to a camera which it will maintain also over power off and restart cycles.

**Network settings performed in this dialog become valid but after a reboot of the camera.**

In addition to a persistent network address it can be decided whether the camera will try to obtain a dynamic network address from a DHCP server on start-up. If this option is used the camera can no longer be identified uniquely by IP address. Instead, other items like MAC address, serial number or the user defined name can be used for this purpose. Usually the DHCP method is convenient for involving a camera in to an already existing

network of computers which all obtain their IP addresses from a DHCP server. The camera will well behave in this environment when adjusting it also to the DHCP mode.

In some cases it may be that a camera will be connected for performance reasons directly to a dedicated network card. Given that this network card has not got assigned a valid IP address there is a **fall-back procedure** defined which takes automatically a network address from a special range that has been assigned for this purpose. This is the so called “**Link Local Address (LLA)**” behavior that constitutes the last item in a chain of fallback cases. It has been defined in the **GigE Vision standard document** that the LLA fall-back procedure can never be deactivated. Therefore the LLA checkbox is deactivated but always in a checked state.

Currently the default gateway setting is not used and therefore deactivated. This is related to performance considerations which recommend to operate GigE cameras in the same network segment where the clients exist and not to route the data stream in to other networks.

### 3.2.3 Using jumbo frames

The transport efficiency in the streaming channel can be improved when using “jumbo frames” in network transport. This will reduce the overhead which is caused by maintaining header data with each data packet. A network packet has usually a size of about 1500 bytes which can be increased to e.g. 9014 (recommended) by switching “jumbo frames” on. In addition to the network card “jumbo frames” have to be supported also by a switch that forwards the image data stream from a camera to the PC.

Adjusting higher packet sizes requires network cards that support jumbo packets, e.g. Intel PRO/1000 PT which offers a single network port or Intel PRO/1000 PT which offers two network ports. Other cards have to be checked whether they contain an adjustment which allows for switching “jumbo frames” on.

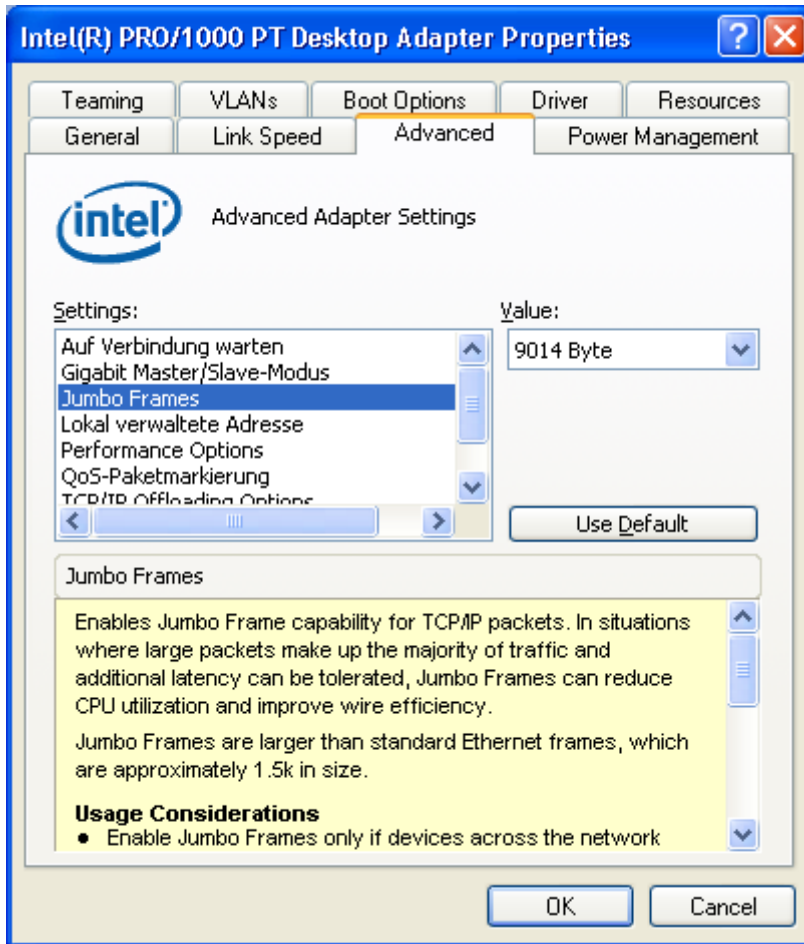

**NOTE:** For Intel Pro/1000 cards the settings should be adjusted as follows:  
Flow control: Generate  
Interrupt throttling rate: Minimal  
Jumbo frames: adjust to 9014  
All SVCam-GigE cameras support flow control and jumbo frames.

### 3.2.4 Performance considerations

Each GigE camera is a **high-performance device**. In order to use the full performance of a GigE camera a PC is required that meets at least the data transfer figures that the connected camera is capable to deliver to the application.

For example, a sv5625MFGE camera delivers a compound image data stream consisting of two times 50 Megabytes/sec. of payload data plus network overhead. Therefore the PC that operates that camera should be capable of transferring that amount of data as a net data stream over all its internal components like network card, PCI bus and others. A PC with a dual core i5 or i7 processor and an Intel PRO 1000 MT network card may serve as an example of a well equipped system.

**NOTE:** All SVS GigE cameras can also be operated with computers of less performance than the camera delivers at highest framerate. In this case the maximal available framerate will be below the camera's maximum. This is a valid operating mode, however one has to be aware of the limits.

**HINT:** Notebooks are in most cases not capable to operate data streams at the maximum level that SVS GigE cameras deliver. One has to be aware that

connecting a SVS GigE camera to an average notebook will not allow for operating the camera at highest framerate but only on lower framerates.

**3.2.5 Connecting multiple cameras to a PC ONLY if 1 GigE output (out of 2) is used !**

**Using Dual GigE channels (2 cables) with a Switch is NOT supported**

**Only MANAGED (intelligent) switches must be used. Otherwise Multicast will not work.**

Multiple GigE cameras can be connected to a PC either using a switch or using dual or quad port network interface connectors (NIC). The following image shows the basic connection schemes which may also be combined.

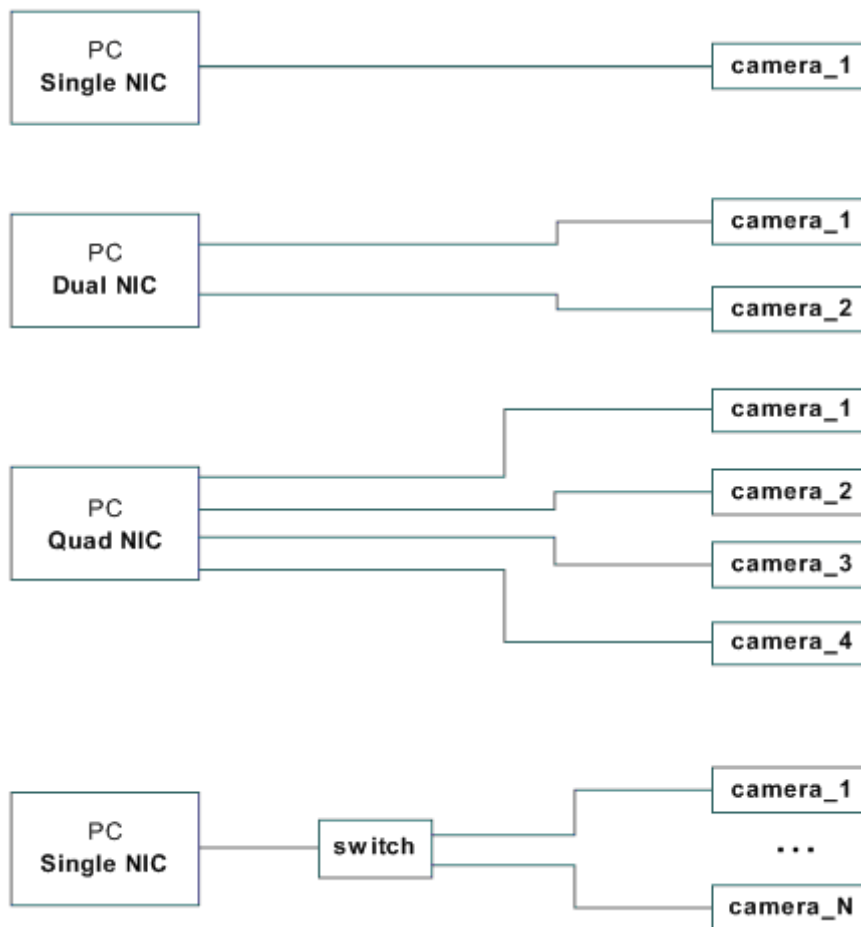

**HINT: Highest performance requires connecting each camera to a separate port of a NIC. If on the other hand multiple cameras are connected to a single NIC using a switch, it might be necessary to operate those cameras with an "inter packet delay" in order to make the image data streams run smoothly on a single GigE line.**



### 3.2.6 Multicast **ONLY if 1 GigE output (out of 2) is used !**

When images from a single camera are to be delivered to multiple PCs the usual way is to use multicast (RFC 2236). A switch receives an image data stream from a camera and distributes it to multiple destinations in this mode.

Since a GigE camera always needs a single controlling application, there will be only one master application. That controlling master application has to open a camera in multicast mode (IP 232.x.x.x for local multicast groups) for allowing other applications to connect to the same image data stream. Other applications will become listeners to an existing image data stream. They will not get control access to the camera, however their eventual packet resend requests will be served in the same way as for the controlling application.

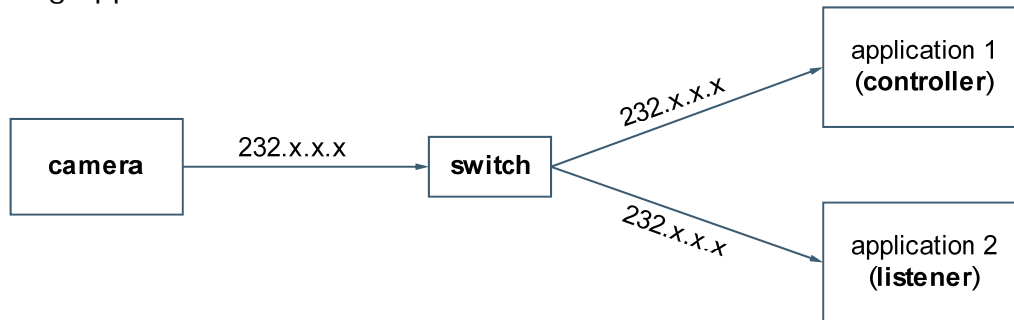

When using SVCapture as the controlling application, the "Multicast" checkbox has to be checked in the Device Discovery dialog before opening a camera.

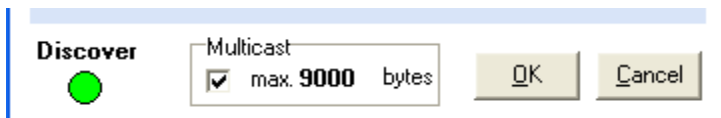

It is important to enter a suitable maximal packet size. This packet size is determined as the minimum packet size from all intended listeners. When for example all applications but one have jumbo frames adjusted to 16112 bytes and the one application has jumbo frames adjusted to 9000 bytes then the minimum (9000) has to be entered in the above shown dialog.

A multicast data stream can be identified in SVCapture by a change in a camera view's title. A multicast group (232.x.x.x) along with the used port will be shown instead of a camera's MAC that is usually displayed in that place.



Further the camera is operated as usual in the controlling application without any changes to normal mode.

A listening application will see a hint "MULTICAST" in the "IP address" field of the discovery dialog for a camera that is streaming in multicast mode along with the IP address of the multicast group.



The “Multicast” group box will display the packet size that applies to the running image data stream. **The listening application has to have at least that packet size available (jumbo frames) in order to properly connect to the image data stream.**

After selecting the multicast camera in the camera list of the discovery dialog the OK button can be clicked or the camera entry can be double clicked in order to connect to the already running image data stream.

Since the listening application does not have control access, all controls in the ‘SVCam Settings’ dialog will be disabled except the Close button.

### 3.2.7 Displaying live images

Connect a SVS-GigE-Camera with a network cable to your PC or network switch.

Plug in the RJ 45 Camera connector and then plug in the AC/DC power supply. Wait 15 seconds until the green LED at the RJ45 connector of the Camera blinks sometimes. Then start “SVCapture.exe”.

After start of “SVCapture.exe”



A "Discovery" dialog will open and will display all available cameras in the network after a short time of discovery. Cameras that become available or unavailable in the network will cause the list to expand and shrink dynamically. A green "Discover" lamp signals that the network is scanned for those changes, usually once per second. The screenshot below shows one camera connected.

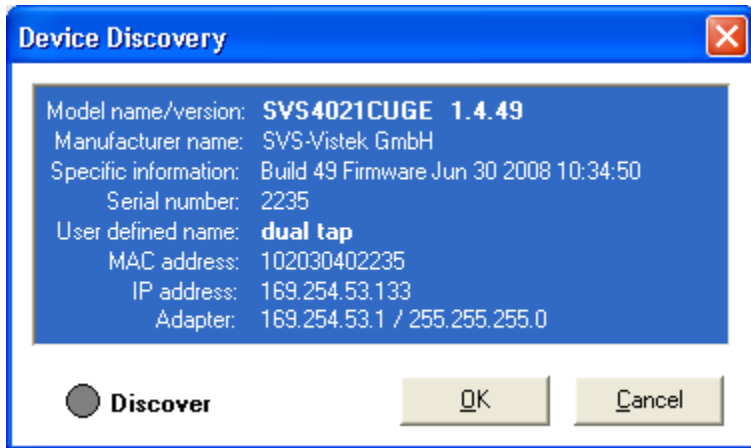

When clicking on "OK" or double-clicking on the camera entry a live image will be displayed.

**If the dialog above is PINK, use right mouse click and choose e.g. "Automatic IP" assignment.**



The caption of the program window shows the program name and the current version whereas the caption of the camera view shows the camera name and camera firmware version along with the MAC address that the camera has been set during manufacturing and prior to shipping as default values.

### 4 Camera settings dialog

Double clicking into the image area or selecting the "Camera settings" entry in the "Camera" menu brings up a settings dialog that allows for accessing the various camera settings:

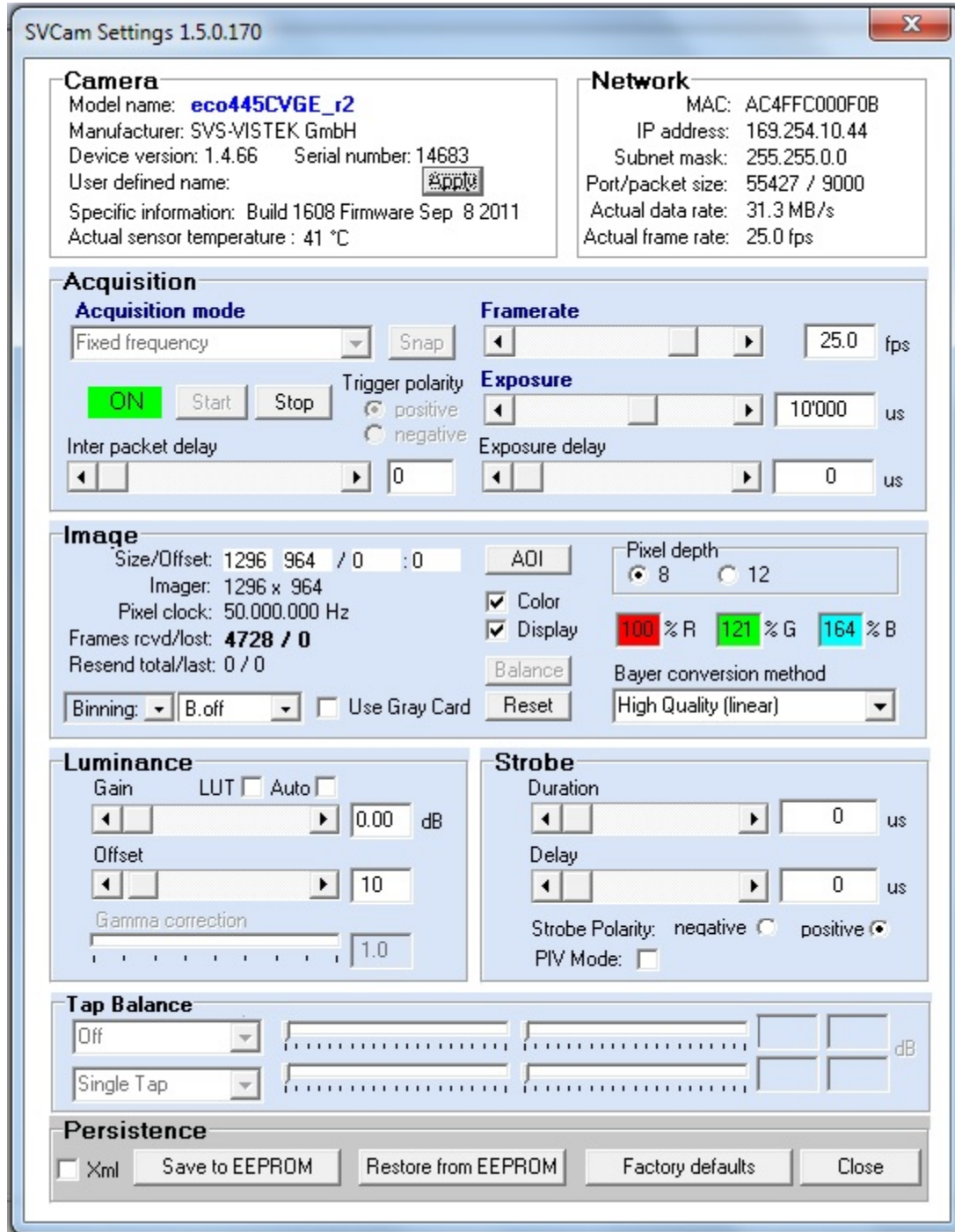

While adjusting settings in the dialog the new values are transferred to the camera continuously and the live image will respond to all changes immediately. In particular the following information and settings are available:

### 4.1.1 Camera

In the camera panel the following information is queried from the camera and displayed:

- Model name : **svsZZZZXYGE**
- Manufacturer name : **SVS-VISTEK**
- Serial number
- Device version
- User defined name
- Firmware version including Number, Month and Year
- Temperature at imaging sensor

### 4.2 Network

The network panel shows the currently used network related settings and parameters. These are in particular:

- The camera's MAC address
- The camera's IP address
- The camera's subnet mask
- The camera's streaming port and streaming packet size
- The actual data rate
- The actual frame rate

### 4.3 Acquisition

The acquisition panel contains the settings that are related to image acquisition as follows:

- Acquisition mode: (free running, software trigger, external trigger with internal / external exposure)
  - **Free running/Fixed frequency:** At the first installation it should be this mode. In this mode the camera creates all sync signals itself. There is no need to trigger the camera (by EXSYNC) in order to get data. **The Exposure time can be set by using the software Interface of the PC** It is controlled by the internal FPGA. No further external signals. The enclosed program allows the user to set the values from e.g. about 1/100.000/Sec and several seconds (type depending). Exposure time can be changed online during operation. The framerate can be adjusted as well.

- **External trigger and using Pulse width of TRIGGER (external exposure)**

In this mode the camera is waiting for an external trigger which causes the integration and read out. The exposure time can be varied by the length of EXSYNC between the high going edge and the low going edge. The Time settings in the control menu are not activated. This mode is useful in applications where the light level of the scene changes during operation. A frame to frame variation is allowed. Trigger must be fed directly to the camera by into the Hirose connector. A TTL (**min. 5 V**) signal is provided from encoder, flashlight or any other source. Details see chapter 5.4.3.

➤ **Software triggered and using PC**

The frame rate is determined by the number of Software TRIGGER pulses generated inside the PC per time. With each "Software pulse" the camera will readout a frame. The Exposure time is set as in free running mode. Exposure time can be changed online during operation.

**Software triggered operation should only be used when latencies are considered as neglectable !!!**



- Frame rate: It allows to alter the frame rate between 1 and the specified maximum value.
- Exposure: The exposure time can be set in  $\mu\text{sec}$ . The min exposure time is about 50  $\mu\text{sec}$  (depending on the camera type and speed). The longest is about several seconds (triggered modes). Due to the internal timing of the camera the program will adjust the values to the appropriate values.
- Acquisition control (Start / Stop)
- Single capture button (Snap)
- Exposure (enter values > 2 sec. [2..85 sec.] into the Edit filed)
- Exposure delay
- Trigger polarity (positive/negative)
- Single capture button: Takes a single shot of the actual scene
- Inter-packet delay

The inter-packet delay has impact on a camera's bandwidth usage. A setting of an inter-packet delay of zero will send all image packets as fast as they are available dependent on the camera's pixel clock, e.g. at 50 MHz. This is the preferred setting when operating a single camera on a network interface.

In case of multiple cameras or other devices working on the same physical network it might be desirable to send the packets of a camera's streaming channel with a certain inter-packet delay in order to allow multiple cameras or devices to share a given network bandwidth.

**NOTE: The inter-packet delay should be below the value which would decrease the frame rate.**

## 4.4 Image

The image panel displays information about the picture geometry, the pixel clock and it allows for the following settings:

- AOI (area of interest) which can be less or equal the imager size
- Binning mode (off, vertical, horizontal, 2x2)  
**No Binning** = full resolution: horizontal x 1, vertical x 1 (default setting)

H2 x V2 x: vertical 2 x and horizontal 2 x at the same time; Resolution: horizontal x ½, vertical x ½, Sensitivity is 4 x, pixel frequency is halved, max. frame rate is almost doubled. "No Binning" sets the camera to full resolution, H1 x 2 and 2 x 1 binning is also available

If you need other binning mode configurations consult factory or your nearest distributor.

Please note: **Using binning with a color version of the camera will cause incorrect colors and strange effects!** However, for fast focusing it might be useful.

- Pixel depth (8 Bit, 12 Bit, 16 Bit, if supported by camera)
- Color (On/Off)
- Bayer method (Off, Bilinear, HQ Linear, Gray)
- Factors for white balance (Red, Green, Blue)
- "Balance" button for performing automatic white balance
- "Equalize" button for setting all colors to 100%
- Freeze (display switched off while acquisition continuous, for test purposes)

In addition the number of transferred frames is displayed as well as the number of eventually lost frames. A frame loss may happen for example in case of an insufficient network bandwidth or if the network connection gets interrupted for a short time or in case of other network failures. Further the number of resent network packets is displayed. The second number is the last resent packet number and the first number indicates the total number of resent packets.

## 4.5 Gain

The gain panel allows for adjusting gain and Autogain with the following controls: The default gain setting is "0" dB. You may change the gain up to 6 dB (or higher) in steps of 1/10<sup>th</sup>. Note that the dark offset will increase and dynamic range will not be improved. Please note that noise also is amplified. For good image quality do not increase gain more than 6 dB; **higher Gain is possible but not specified!**

**Please note that some CCD have 4 instead of only 2 outputs.** Therefore there are a upper right and lower right "image" (quarter) and for the left side equivalent. You can use the slider both channels are amplified. However depending on the amplifications there might be different values necessary in order to make both channels equal. **Fine tuning in "Gain" is necessary.** It is still possible to have 1 count difference between 4 image quarters. **This is NOT a camera problem and must be adjusted by an experienced user. Same is true for the offset.**

- Gain (0.....18 dB) (The edit field allows for an extended gain up to about +36 dB, dependent on the camera's capabilities)

**Autotap balancing function can be enabled to avoid manual tuning. Note that Continuous tap balancing needs a few frames to adjust !!**

### 4.5.1 Offset

Dark level offset adjustment is possible. When 8 Bit are transmitted it can be changed from 0 to 255. Please note that factory adjustment is optimized for S/N ratio and sensitivity. You may lose dynamic range. Alter only if you operate at high temperatures like +40 °C. It can be altered for each channel separately. (for 2 tap Kodak CCDs).



### 4.6 AutoGain/AutoExposure / **Planned**

When the "Auto" checkbox is activated for cameras that provide for the AutoGain/AutoExposure feature, the "Luminance" panel changes to show the settings that apply to this mode of operation. The manual settings for gain and offset will disappear since the luminance will be controlled automatically.

The automated luminance control algorithm takes advantage of both, exposure and gain settings. First the exposure will be tried to adjust it such that a set brightness value will be met. Once the highest exposure value has been reached the algorithm will further increase luminance by increasing camera's gain. The upper and lower limits for both controls are available in the "Luminance" panel once the "Auto" checkbox is checked.

The actual exposure is shown on the "Acquisition" panel and the actual gain is displayed in the "Luminance" panel on the left to the "min" and "max" gain settings.

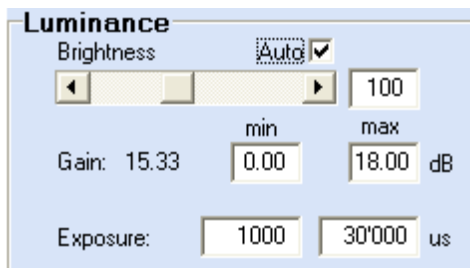

### 4.7 Tap configuration

Sensors having more than 2 taps like in hr16050, h1607 and hr29050 (see Auto tap balance below) can be configured so, that 1,2 or 4 taps can be chosen.

- 1 tap= 100 % of one sensor output.  $1X + 1Y$
- 2 tap= 2 x 50 % horizontal, 100 % vertical (left tap/right tap)  $2X + 1Y$
- 2 tap= 2 x 50 % vertical, 100 % horizontal (upper tap/lower tap)  $1X + 2Y$
- 4 taps= 4 x 50 % of horizontal + vertical resolution (4 quadrants, in each corner one)  $2X + 2Y$ .

### 4.8 Auto tap balance

Advanced imaging sensors offer a 2-tap or even 4-tap operation for getting to higher frame rates. For example, a left and a right tap as on the following image have to be perfectly balanced in this case in order to capture high quality images without any visible border on the join between both taps.

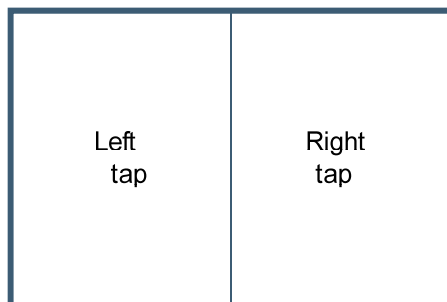

two-tap imaging sensor



### KAI 10002 and KAI 16000



#### 4 tap image sensor

Auto tap balance is usually switched "Off" during normal camera usage. It can be activated for two modes:

- Once
- Continuous

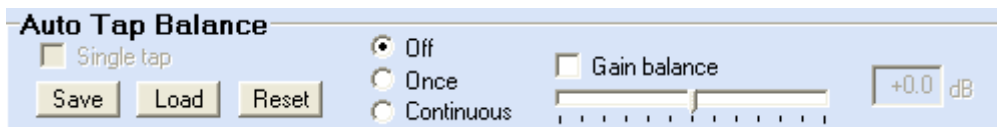

When switched to "Once", captured images will be checked for tap balance and in case of a deviation, new left/right gain factors will be determined and be sent to the camera. As soon as a balance is achieved between left and right channel, the mode returns to "Off" automatically.

Mode "Once" is activated when a camera is opened. After capturing one or multiple images, the mode switches back to "Off" what is the normal state for camera usage.

In case of big changes for gain and/or exposure, it might be desirable to monitor tap balance continuously. In this case the auto tap balance mode should be switched to "Continuous". There is no visible runtime penalty for the "Continuous" mode since only a small stripe in the middle of each image is used for evaluating tap balance.

Current tap balance will be displayed numerically in a range from -1.5 dB to +1.5 dB as well as graphically by a slider. The slider can also be used for manually adjusting arbitrary gain factors. The check box "Gain balance" has to be checked in order to enable the slider for manual adjustments.

Current balance settings can be saved into a file and restored later using the "Save" and "Load" buttons. Appropriate file save/load dialogs will open after clicking on a button. Saving/Loading auto balance settings might be applicable in case of working with different gain/exposure settings regularly. This would avoid the need for running auto tap balance each time after changing the gain/exposure settings.

A camera can also be switched to single-tap if this feature is supported.

### 4.9 Image Flip

SVCapture allows to initiate a vertical or horizontal Image Flip. This is done inside the memory of the camera and so no CPU load of the PC takes place.

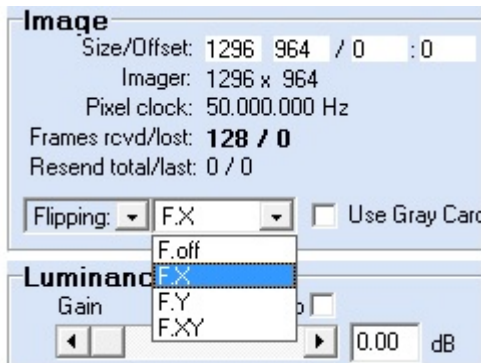

### 4.10 Adjusting an AOI (area of interest)

When clicking on the "AOI" button in the "Image" panel a graph tablet becomes visible that allows for defining an AOI by dragging and resizing a gray target area with a red border inside the imager limits, represented by a rectangle with black borders.

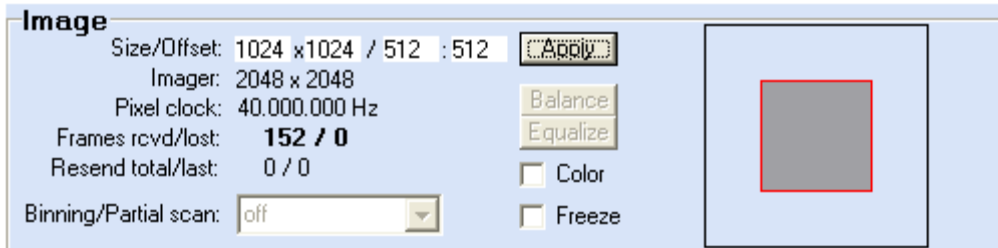

Whenever the left mouse button is released after dragging/resizing the target area, the camera will be adjusted to the new settings. Alternatively the target area can be defined numerically by entering values into the edit fields for Size/Offset and subsequently clicking on "Apply". After clicking on "Apply" the graph tablet will disappear and the new settings are stored in the camera.

### 4.11 Strobe

The strobe panel allows for accessing the following settings for controlling light sources:

- Strobe duration
- Strobe delay (Start of strobe related to a trigger pulse)
- Strobe polarity (positive/negative)

### 4.12 Persistence

The buttons in the persistence panel allow for saving and restoring all settings:

- Save to EEPROM
- Restore from EEPROM
- Factory defaults
- Close

## 5 Saving images to disk

The live image can be saved to disk with the “Save as” item in the Image menu. After selecting a path and specifying a file name a picture in one of the formats JPEG, PNG (Portable Network Graphics), BMP or PIX (raw pixel data) will be saved to disk. Saving of 16 Bit images is supported by the PNG and PIX (raw pixel data) formats.

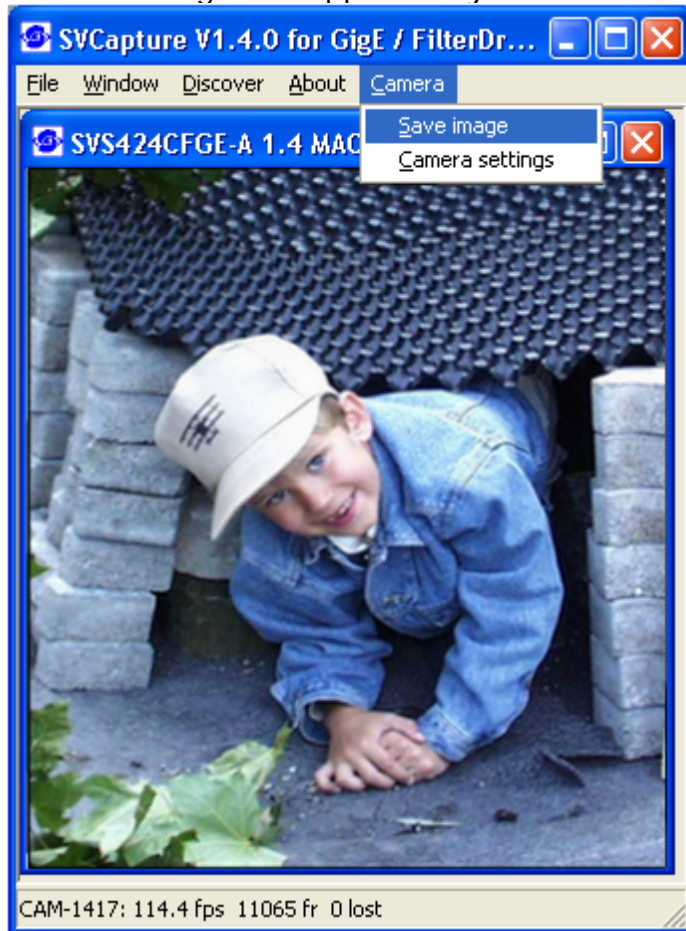

## 6 Flat Field and Shading Correction

Flat Field- and Shading Correction are methods to compensate for uneven illumination. While FFC is working on each single pixel, Shading Correction will interpolate between them. To perform Shading Correction is easier as it does not need a dark image.

**1) Performing Flat Field Correction for SVS-VISTEK cameras .** Applies for HR series with GigE interface: **svs11002, svs16000,**

In order to perform a correction for an image with different pixel values a “dark” and a “white” image has to be taken. This will allow to create correction values to “adjust” the pixels by individual gain settings. Correction values for Flat Field Correction can be generated with SVCapture/Camera/ Flat Field Correction (Version SDK 1.4.23.55-1 or later).

Auto or manual Whitebalance should be completed before acquisition of correction values for Flat Field Correction.

For an optimum resolution Pixel depth has to be set to 12bits/pixel.

8 frames are taken for averaging the dark and white image.

1. Generation of the dark image for offset correction:  
The Camera has to be darkened.
2. Generation of the white image for gain correction:  
An optimum white image would consist of a uniform image with only one pixel value. Pixel values lower than the brightest value are adjusted via the pixel gain factor. The maximum gain factor is 4 (relatively to initial gain setting). A better grey value resolution with maximum gain factor 2 can be achieved, when the factor between the lowest and the highest pixel value of the white image is smaller than 2. The white image should be uniform, without saturation. To suppress small image structures, the camera has to be **defocused**.
3. Permanent storage of the correction values inside the camera:  
The generated offset and gain correction values can be stored to the non volatile memory of the camera.

**Follow the instructions which are guided by pop up windows step by step.**

- **Defocus the image by adjusting the lens**
- **Set “pixel depth” in SVCapture GUI to 12 bit**
- **Go to “camera” menu “Flat Field Correction”**
- **Click on “get dark image”:** E.g. Put a cap on the lens. Wait until 8 images have been taken.

- Click on "get white image". Make sure no part in the image is "black" or "white". The latter means no pixel should be in "saturation".
- Click on "save FFC": Data are now stored inside the camera. Wait a moment. Click at last on "write done OK".
- Tick box "FFC active": Note change in image !

**You are done and FFC can be used for the application.**

## **2) Performing Shading** correction for SVS-VISTEK cameras. Applies for HR series with GigE interface: All "evo" versions **hr16050 and hr16070 and hr29050**

In order to perform a correction for an image with different pixel values a "white" image has to be taken. This will allow to create correction values to "adjust" the pixels by individual gain settings. Correction values for Shading Correction can be generated with SVCapture/Camera/ Shading Correction (Version SDK 1.4.23.56 or later).

Auto or manual Whitebalance should be completed before acquisition of correction values for Shading Correction. For an optimum interpolation Pixel depth should be set to 8bits/pixel.

8 frames are taken for averaging of white images.

### 1. Generation of the white image for correction:

An optimum white image would consist of a uniform image with only one pixel value. Pixel values lower than the brightest value are adjusted via the pixel gain factor. The maximum gain factor is 4 (relatively to initial gain setting). A better grey value resolution with maximum gain factor 2 can be achieved, when the factor between the lowest and the highest pixel value of the white image is smaller than 2.

The white image should be uniform, without saturation.

To suppress small image structures, the camera has to be **defocused**.

### 2. Permanent storage of the correction values inside the camera:

The generated gain correction values can be stored to the non volatile memory of the camera.

**Follow the instructions which are guided by pop up windows step by step.**

- Defocus the image by adjusting the lens
- Set "pixel depth" in SVCapture GUI to 8 bit
- Go to "camera" menu "Shading correction"
- Click on "get white image". Make sure no part in the image is "black" or "white". The latter means no pixel should be in "saturation".
- Click on "save": Data are now stored inside the camera. Wait a moment.
- Set image correction to "enabled"
- Note change in image !

**You are done and SC can be used for the application.**

## 7 Assigning IO lines

If a camera supports IO settings then the input and output lines can be arbitrarily assigned to actual data lines. (HR and eco family)

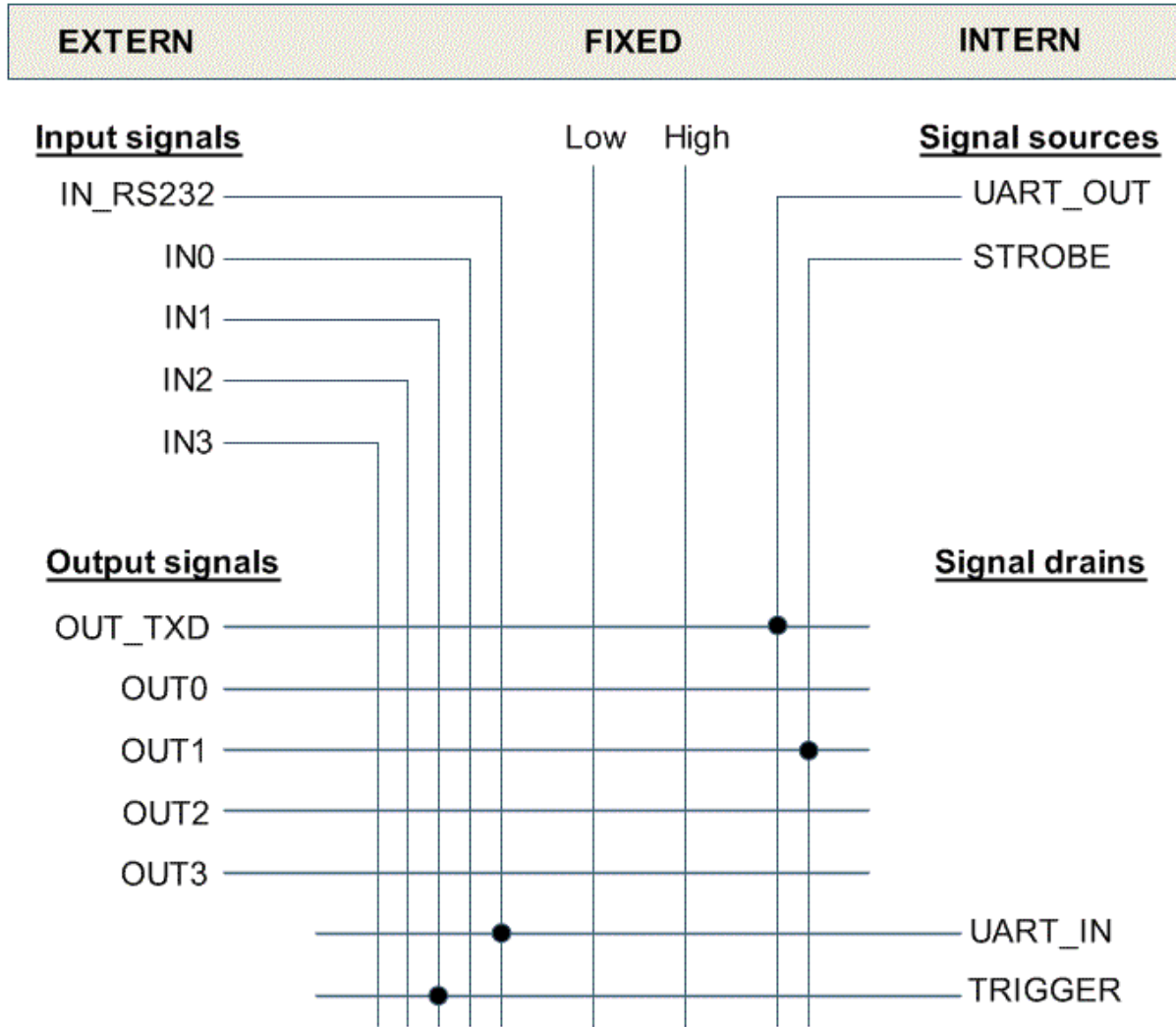

Chart: Flexible IO assignment matrix for SVS VISTEK cameras (with default settings)

The following outputs are available:

- OUT0 (only in HR family, not for eco family)
- OUT1
- OUT2
- OUT3
- OUT\_TXD

Those output lines can be connected to the following signal sources:

- UART\_OUT
- STROBE
- any of the input lines
- fixed signals Low or High

The following input lines are available:

- IN0 (only in HR family, not for SVS version)
- IN1
- IN2
- IN3
- IN\_RS232

The input lines can be connected to the following signal drains:

- UART\_IN
- Trigger
- any of the output lines

The dialog allows for assigning signal sources to all physical output lines and for assigning physical inputs to logical input signals (signal drains). When clicking on 'Apply' after making all adjustments then the new assignments take effect. One has to click on 'Save to EEPROM' in order to make them persistent. In case of any problems the 'Factory defaults' can be restored by clicking on that button. Source signals show current input.

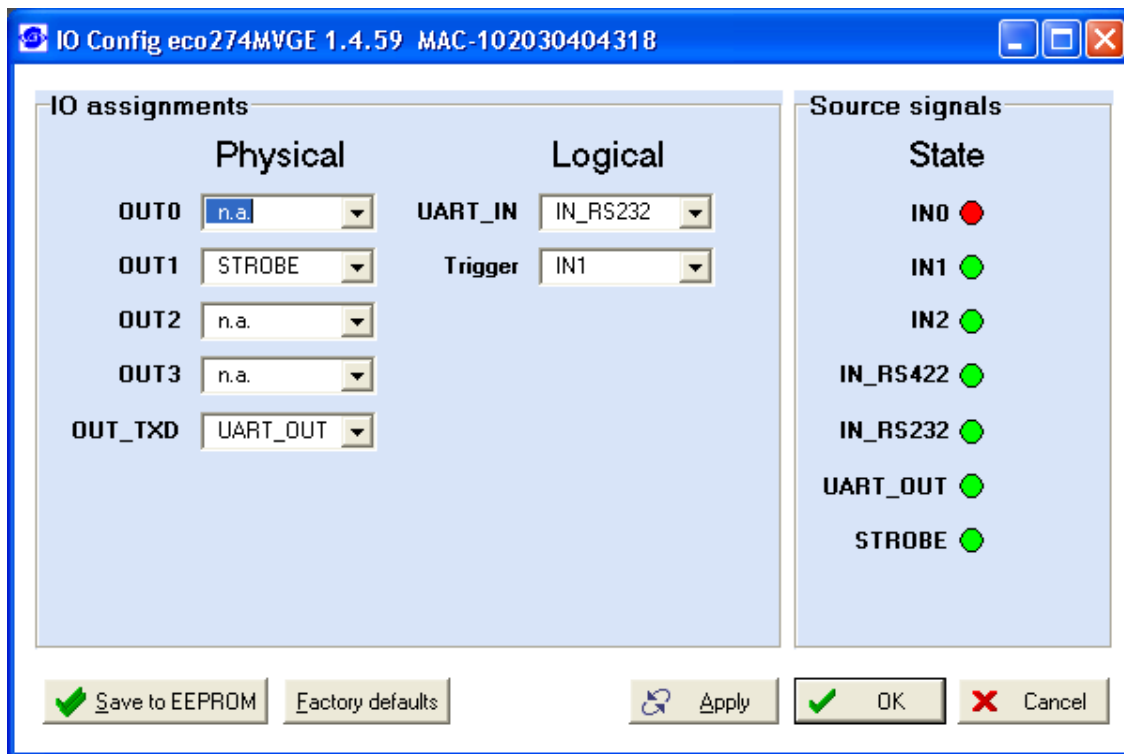

## 8 Displaying a camera's XML file

Accordingly to the GigE Vision standard a GigE camera provides for an XML file that defines the camera's capabilities. Though the XML file will usually be processed by software, the SVCapture application allows for displaying a camera's XML file on screen and saving it to disk. This functionality is available in the "Camera" menu when clicking on the "Show XML file" entry.

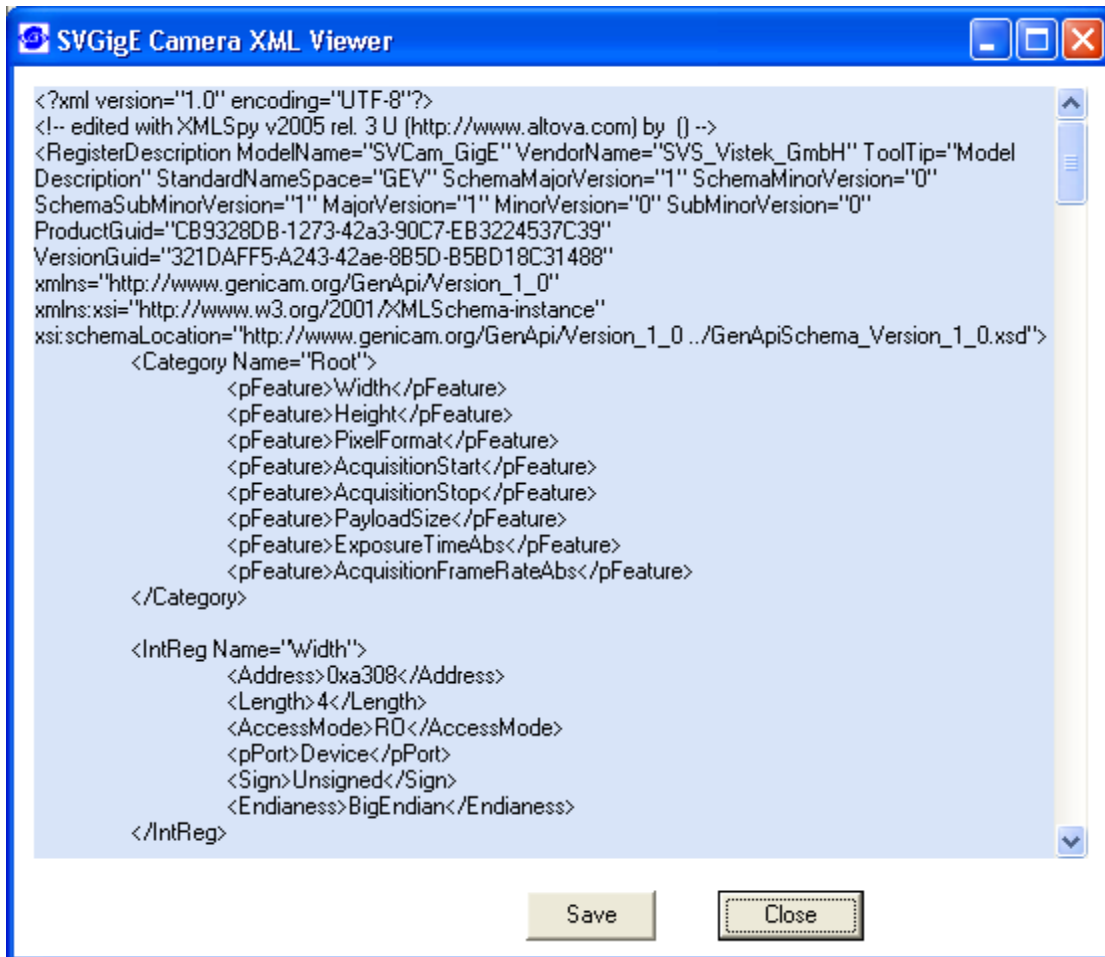



## 9 Displaying a camera’s feature list

A SVGigE camera provides for a set of features out of a list of all defined features. The “Feature list” entry in the “Camera” menu allows for getting information which features a given camera provides for and which are not available.

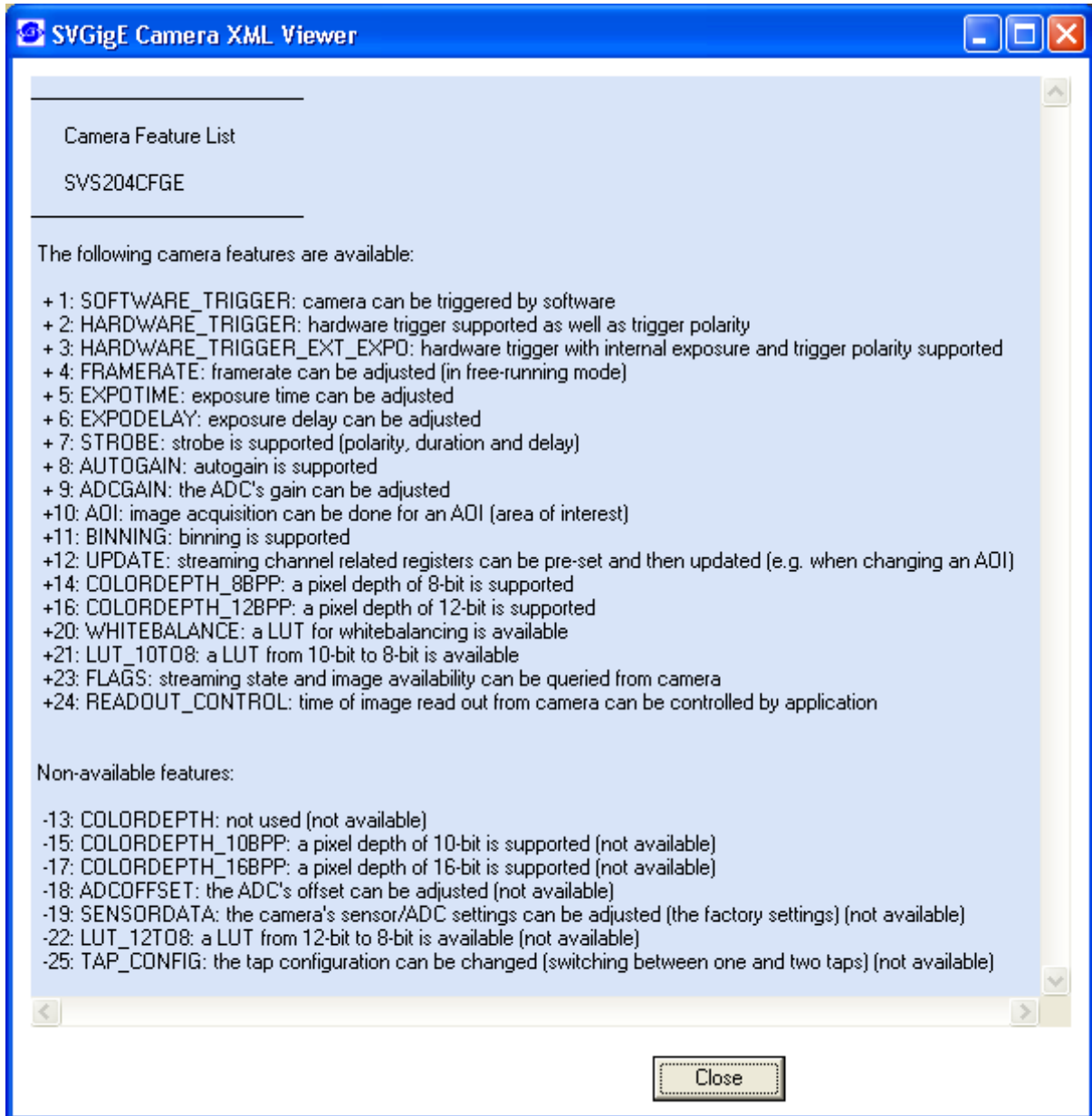

## 10 Other menu items

- File | Enable filter driver - Enable or disable a filter driver
- File | Exit - Leaving application
- Window | Cascade - Cascade camera views in main window
- Window | Tile - Assign each camera view a share of main window
- Window | Delete - Close camera view that currently has the focus
- About - Program and version information

## 11 Context menu

A context menu can be activated in the image window by right clicking on the mouse inside that window. The following functions can be controlled by this menu:

- Displaying pixel coordinates and values
- Reducing the size of an image to 12,5%
- Reducing the size of an image to 25%
- Reducing the size of an image to 50%
- Restoring the original 100% size of an image
- Magnifying resolution to 200% (image fragment scrolled by left mouse click)
- Magnifying resolution to 400% (image fragment scrolled by left mouse click)
- Magnifying resolution to 800% (image fragment scrolled by left mouse click)

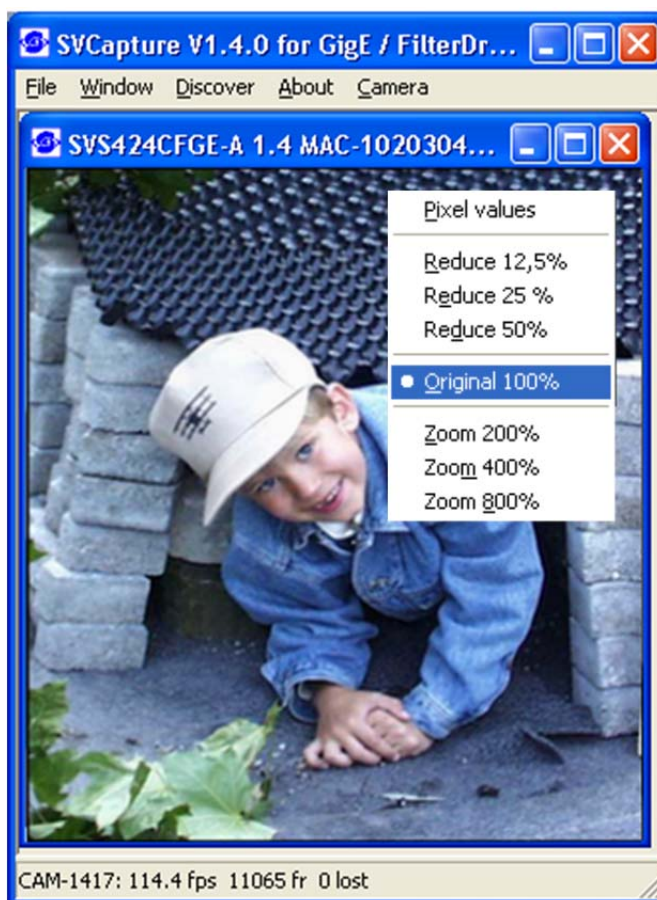

If "Pixel values" is selected the display switches in the bottom left corner to displaying the min and max values at cursor position along with the difference max-min which represents the image's noise amplitude at cursor position:

CAM-1447: X=1451 Y=286 Pixel: 102 (min: 100 max: 103 dif: 3)

## 12 Firmware update

A separate tool called "Firmware Update Tool.exe" is provided to execute a firmware update



**Depending on serial number a firmware update for the internal camera logic might be useful or necessary. This can be essential in order to use the current available SVCapture or SDK.**

**Using unmatched Hardware and Software (e.g. HW 1.4. with SW 1.5) will NOT work. Numbering is consistent. So 1.4 SW requires 1.4 firmware!**

**Since 1.4.26.61-1 the same tool can be used to perform a downgrade to previous firmware version.**

**In doubt contact your local distributor.**

## 13 TECHNICAL DATA

An easy logic allows control of the camera by different signals to achieve optimum image quality. However Truesense (Kodak) defect specification applies.

### 13.1 CCD used/cosmetic issues:

#### 13.1.1 Sensors:

- Truesense (formerly Kodak) KAI 11002M/C4008 x 2672 pixel
- Truesense (formerly Kodak) KAI 16000M/C 4872 x 3248 pixel
- Truesense (formerly Kodak) KAI 16050M/C 4872 x 3248 pixel
- Truesense (formerly Kodak) KAI 16070M/C 4872 x 3248 pixel
- Truesense (formerly Kodak) KAI 29050M/C 6576 x 4384 pixel

#### 13.1.2 Cosmetic Specs

##### 13.1.2.1 KAI 11002M Class I

Cluster allowed. Cluster may contain up to 20 pixel out of PRNU spec.  
20 cluster allowed. Point defects: 1000 pixel dead or out of PRNU spec. (color version up to 2000) Column defects: 0.

##### 13.1.2.2 KAI 16000M Class I

Cluster allowed. Cluster may contain up to 20 pixel out of PRNU spec.  
30 cluster allowed. Point defects: 1500 pixel dead or out of PRNU spec. Column defects: 0.

##### 13.1.2.3 KAI 16050M + C Class I

Cluster allowed. Cluster may contain up to 20 pixel out of PRNU spec.  
30 cluster allowed. Point defects: 1500 pixel dead or out of PRNU spec. (color version up to 3000) Column defects: 0.

##### 13.1.2.4 KAI 16070M + C Class I

Cluster allowed. Cluster may contain up to 20 pixel out of PRNU spec.  
30 cluster allowed. Point defects: 1500 pixel dead or out of PRNU spec. (color version up to 3000) Column defects: 0.

##### 13.1.2.5 KAI 290002M/C Class I

Cluster allowed. Cluster may contain up to 23 pixel out of PRNU spec.  
50 cluster allowed. Point defects: 3000 pixel dead or out of PRNU spec. (color version up to 6000) Column defects: 0.

More details are available in the sensor spec sheet available from "Truesense Imaging" website.

### 13.1.3 Pixel Defect Correction

Some camera models feature the possibility to correct pixel defects which are default on delivery from Truesense Imaging. See above "Cosmetic Specs". The following options are available:

- Defect Map delivered from Truesense Imaging can be called from the camera.
- Custom Defect Map can be created by the user. A simple txt file with coordinates has to be created. To do so the pixel defects must be located manually. The txt file can be uploaded into the camera. Beware of possible Offset !
- Defect maps can be switch off to show all default defects. Or can be switched on to improve image quality.

**Note:** Defect Correction is based on Software algorithms which will create pixel grey level values on neighbourhood information in order to replace zero information of faulty pixel.

### 13.1.4 Spectral range

- 400-900 nm(B/W)
- COLOR version: RGB Bayer Mosaic Filter, **see 12.1.4**

### 13.2 Gain balancing (in case of 11 and 16 MP "F" + "U" version and if set to 2 tap /"L" version)

The output for the "F" + "U" version is as follows:

2 taps are read out and the right half of the image is mirrored. It is put together correctly without user access. **HOWEVER: As a result changing gain for the complete image requires fine gain tuning separately for both images halves.** It is not necessary for the "S" version (One tap sensor output).



2 Tap sensor output "F +U"



1 Tap sensor output "S" version

Note: "F" + "U" version:



Note that the CCD has 2 outputs. Therefore there are a "right" and a "left" image half. If you use the slider both channels are amplified. However depending on the amplifications there might be different values necessary in order to make both channels equal. Fine tuning in "Gain Value" is necessary. It is still possible to have 1-2 counts difference between both image halves. This is NOT a camera problem and must be adjusted by an experienced user. Same is true for the offset. For dynamic adjustments see "Auto tab Balance".

- Gain (0 ... 18 dB) Higher gain possible, depending on camera type.

**hr16050/70 and hr29050 have 4 taps. Autotap balancing is recommended.**

### 13.2.1 Sensor/ADC settings for tap balancing . **DUAL tap cameras**

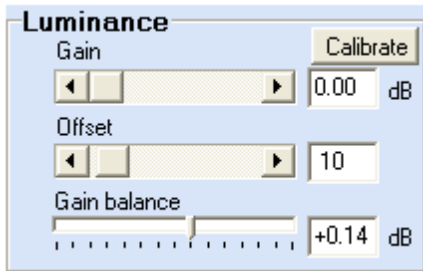

A dual-tap camera will usually have the “Sensor/ADC Adjustment” feature enabled which results in a “Luminance” panel with additional fields and controls. Current gain balance between a left and a right sensor tap is displayed in the right bottom field in dB where a higher gain for the right tap results in a positive balance value. The current (volatile) balance can be adjusted by a “Gain balance” slider on the bottom.

A single set of gain/offset factory settings are stored in the camera. Those settings determine the zero point for the user accessible gain and offset values, usually called calibration values. The factory settings for those values become available for change when clicking on the “Calibrate” button. A warning will be issued as follows:

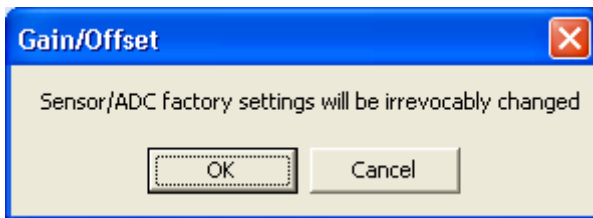

After confirming the warning dialog with OK a “Sensor/ADC” panel becomes available and replaces the “Luminance” panel.

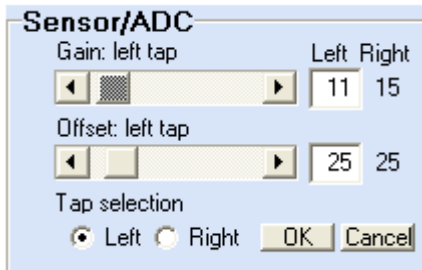

Clicking on Left and Right radio buttons or directly on the gain/offset values makes those values accessible for changes. They can be changed by slider or by editing them in the edit field. Once having finished with adjusting all values the OK button can be clicked for making the new settings persistent in the camera.

**NOTE:** Factory settings for gain/offset will be irrevocably overwritten when onfirming the final message box with OK:

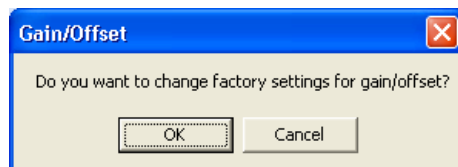

### 13.3 Signal conditioning

The analog output of the sensor is conditioned by Correlated Double Sampling (CDS) for optimum S/N ratio. Dark level drift is compensated by an "auto zero" amplifier circuit and fed into a video ADC with 10 or 12 (1tap) or 14 Bit (2 tap) bit resolution (type dependent). The data are fed into an internal 16 MB Memory. The camera is controlled by an FPGA and the data packages are sent via an Ethernet controller to the PC.

### 13.4 Optical and mechanical issues

Camera size:	About 65 x 67 x 77 (mm,without connectors and lens)
Weight:	Approx. 400 Gram
Mount 11002, 16000 + 29050:	Front plate with M 58 x 075 mm thread
Mount 4050 + 8050:	Front plate with M 42 x 1 mm thread

Distance from Chip surface to front plate: 11,48mm

#### NOTE:

- **There are several vendors who offer solutions like from Qioptiq + Schneider who offer interfaces to M58 thread. SVS-VISTEK also offers a M58 to F-Mount adapter.**
- **Lenses from e.g. Zeiss (F-Mount) are available on the market, too.**
- **A special adapter for Canon lenses can be purchased from SVS-VISTEK.**
- **Using improper optics will cause vignitation due to micro lenses on Chip.**



### 13.4.1 Tripot Mount

### 13.4.2 Views on front, rear and side

Distance from Chip surface to front plate ring: 11,48mm

#### svs11002 / Left RJ45 not active

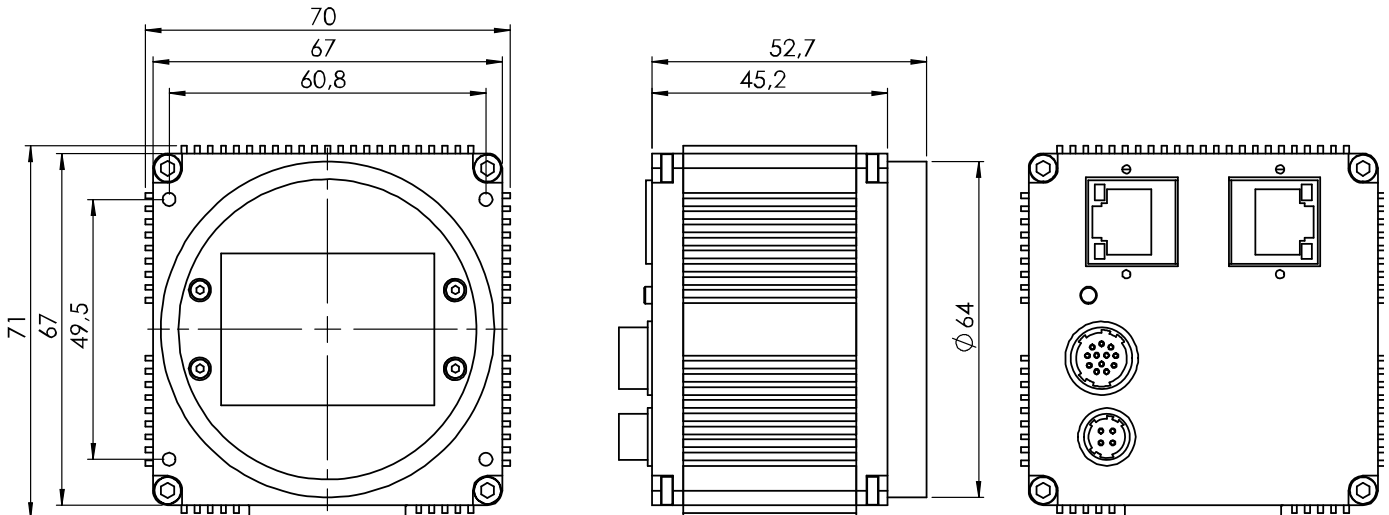

#### svs16000 / Left RJ45 not active

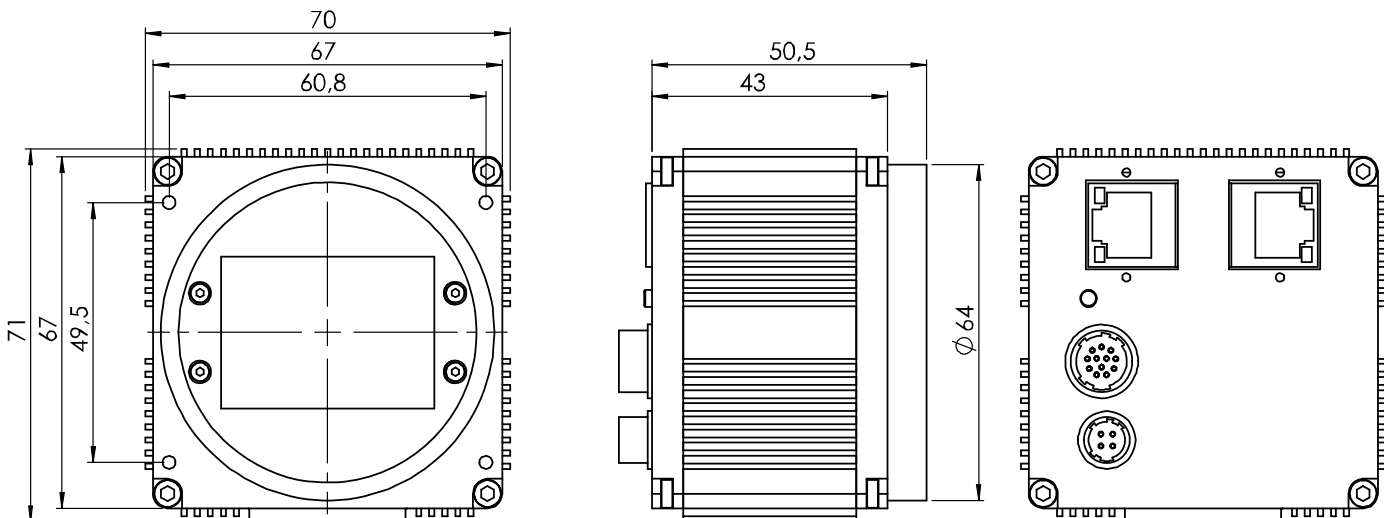

### hr16050/70 and hr29050

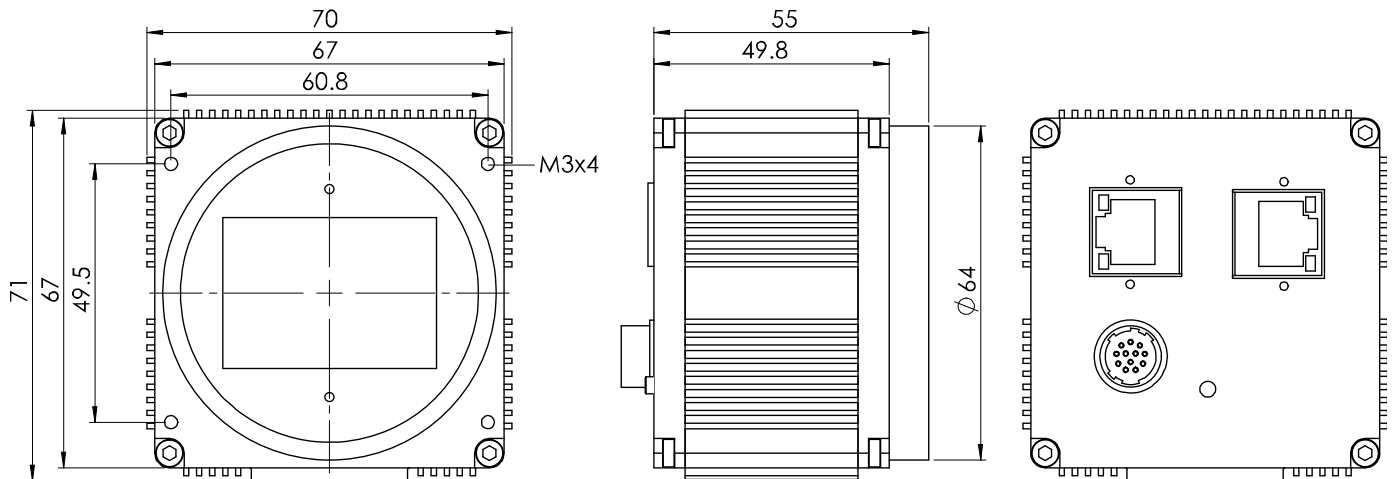

Note: Small CCD of 16050 above not shown

Bottom view

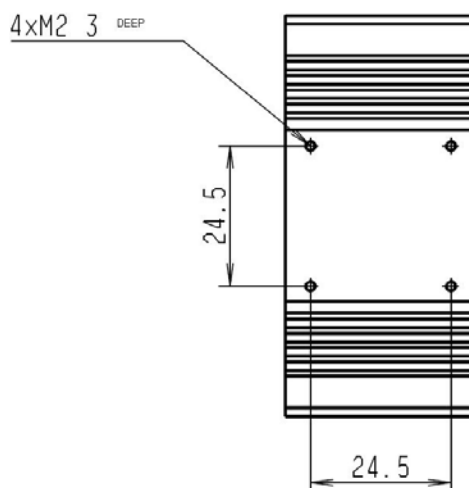

#### 13.4.3 Connectors

**Note that left RJ 45 is only active for 2<sup>nd</sup> Gigabit channel cameras: 16050, 16070 and 29050.**

**If you want to operate above cameras with only ONE port, use the RIGHT one. In case you connect only the left one, some cameras are detected BUT THERE IS NO VIDEO STRAMING !!!**

### HR10A-10R-12PB (mating connector HR10A-10P-12S)

- 1 VIN- (GND)
- 2 VIN+ (10 to 25VDC)
- 3 RXD data to camera (RS232 Level)
- 4 TXD data from camera (RS232 Level)
- 5 IN1 (TTL Level)
- 6 IN2 (TTL Level)
- 7 OUT1 (TTL Level)
- 8 OUT2 (TTL Level)
- 9 IN3+, 10 IN3- (RS422 Level)
- 11 OUT3+, 12 OUT3- (RS422 Level)

**Recommendation: USE PIN 5 as Trigger and 7 as Strobe output.**

GND is common for power, trigger +strobe

### 13.5 Basic electro-optic specifications svs11002 "S" version/12 Bit Output

CCD KAI 11002 Interline	4008 x 2672 pixel	pixel size 9 x 9 $\mu\text{m}$
ADC used	14 Bit max. 12 available	
Readout frequency	1 x 40 MHz (1 tap)	
Frame rate (max.)	3.3 FPS	
OFFSET	ca. 10 counts	
Gain	18 dB max. Specification valid up to 6 dB	
S/N ratio	10 Bit (Saturation/Dark Noise (RMS)) Color version 10 Bit	
Fixed Pattern Noise	+/- 2 counts	
Photo Response Nonuniformity (PRNU)	+/- 10%	
Spectral response	380–950 nm	
Exposure time (internal)	130 $\mu\text{Sec}$ – 2 Sec	

### 13.6 Basic electro-optic specifications svs11002 "F" version/12 Bit Output

CCD KAI 11002 Interline	4008 x 2672 pixel	pixel size 9 x 9 $\mu\text{m}$
ADC used	14 Bit max. 12 available	
Readout frequency	2 x 40 MHz (2 taps)	
Framerate (max.)	4,7 FPS	
OFFSET	about 10 counts	
Gain	18 dB max. Specification valid up to 6 dB	
S/N ratio	10 Bit (Saturation/Dark Noise (RMS)) Color version 8 Bit	
Fixed Pattern Noise	+/- 2 counts	
Photo Response Nonuniformity (PRNU)	+/- 10%	
Spectral response	380–950 nm	
Exposure time (internal)	130 $\mu\text{Sec}$ – 2 Sec	

### 13.7 Basic electro-optic specifications svs11002 "U" version/12 Bit Output

CCD KAI 11002 Interline	4008 x 2672 pixel	pixel size 9 x 9 $\mu\text{m}$
ADC used	14 Bit max. 12 available	
Readout frequency	2 x 50 MHz (2 taps)	
Framerate (max.)	6,2 FPS	
OFFSET	about 10 counts	
Gain	18 dB max. Specification valid up to 6 dB	
S/N ratio	10 Bit (Saturation/Dark Noise (RMS)) Color version 8,5 Bit	
Fixed Pattern Noise	+/- 2 counts	
Photo Response Nonuniformity (PRNU)	+/- 10%	
Spectral response	380–950 nm	
Exposure time (internal)	130 $\mu\text{Sec}$ – 2 Sec	

### 13.7.1 Basic electro-optic specifications svs16000 "F" version/12 Bit Output

CCD KAI 16000 Interline	4872 x 3248 pixel	pixel size 7,4 x 7,4 $\mu\text{m}$
ADC used	14 Bit	
Readout frequency	2 x 30 MHz (2 taps)	
Framerate (max.)	3.3 FPS	
OFFSET	about 10 counts	
Gain	18 dB max. Specification valid up to 6 dB	
S/N ratio	10 Bit (Saturation/Dark Noise (RMS)) Color version 9 Bit	
Fixed Pattern Noise	+/- 2 counts	
Photo Response Nonuniformity (PRNU)	+/- 10%	
Spectral response	380–950 nm	
Exposure time (internal)	160 $\mu\text{Sec}$ – 2 Sec	

### 13.7.2 Basic electro-optic specifications svs16050

CCD KAI 16050 Interline	4872 x 3248 pixel	pixel size 5,5 x 5,5 $\mu\text{m}$
ADC used	14 Bit	
Readout frequency	4 x 50 MHz (4 taps)	
Framerate (max.) "A" version	10,8 FPS	
OFFSET	about 10 counts	
Gain	18 dB max. Specification valid up to 6 dB	
S/N ratio	59 dB	
Fixed Pattern Noise	+/- 2 counts	
Photo Response Nonuniformity (PRNU)	+/- 10%	
Spectral response	380–950 nm	
Exposure time (internal)	17 Sec – 1 Sec	

### 13.7.3 Basic electro-optic specifications svs16070

CCD KAI 16070	4872 x 3248 pixel	pixel size 7,4 x 7,4 $\mu\text{m}$
---------------	-------------------	------------------------------------

Interline		
ADC used	14 Bit	
Readout frequency	4 x 50 MHz (4 taps)	
Framerate (max.)	11 FPS	
OFFSET	about 10 counts	
Gain	18 dB max. Specification valid up to 6 dB	
S/N ratio	10 Bit (Saturation/Dark Noise (RMS)) Color version 9 Bit	
Fixed Pattern Noise	+/- 2 counts	
Photo Response Nonuniformity (PRNU)	+/- 10%	
Spectral response	380–950 nm	
Exposure time (internal)	17µSec – 1 Sec	

### 13.8 Basic electro-optic specifications svs16000 "U" version/12 Bit Output

CCD KAI 16000 Interline	4872 x 3248 pixel	pixel size 7,4 x 7,4 µm
ADC used	14 Bit	
Readout frequency	2 x 40 MHz (2 taps)	
Framerate (max.)	4 FPS	
OFFSET	about 10 counts	
Gain	18 dB max. Specification valid up to 6 dB	
S/N ratio	10 bit (Saturation/Dark Noise (RMS)) Color version 9 Bit	
Fixed Pattern Noise	+/- 2 counts	
Photo Response Nonuniformity (PRNU)	+/- 10%	
Spectral response	380–950 nm	
Exposure time (internal)	160 µSec – 2 Sec	

### 13.9 Basic electro-optic specifications svs29050

CCD KAI 29050 Interline	6576 x 4384 pixel	pixel size 5,5 x 5,5 µm
----------------------------	-------------------	-------------------------

ADC used	14 Bit	
Readout frequency	2 x 50 MHz (4 taps)	
Framerate (max.)	6.2 FPS (8 Bit version)	
OFFSET	about 10 counts	
Gain	18 dB max. Specification valid up to 6 dB	
S/N ratio	10 bit (Saturation/Dark Noise (RMS)) Color version 9 Bit	
Fixed Pattern Noise	+/- 2 counts	
Photo Response Nonuniformity (PRNU)	+/- 10%	
Spectral response	380–950 nm	
Exposure time (internal)	10 µSec – 1 Sec	

## 13.10 Environmental Issues:

### 13.10.1 Europe

The camera is CE tested and the rules of EN 50022-2 apply.

### 13.10.2 USA and Canada

#### I. Labeling requirements:

This device complies with part 15 of the FCC Rules. Operation is subject to the following two conditions: (1) This device may not cause harmful interference, and (2) this device must accept any interference received, including interference that may cause undesired operation.

#### II. Information to the user:

Note: This equipment has been tested and found to comply with the limits for a Class A digital device, pursuant to part 15 of the FCC Rules. These limits are designed to provide reasonable protection against harmful interference when the equipment is operated in a commercial environment. This equipment generates, uses, and can radiate radio frequency energy and, if not installed and used in accordance with the instruction manual, may cause harmful interference to radio communications. Operation of this equipment in a residential area is likely to cause harmful interference in which case the user will be required to correct the interference at his own expense.

Camera complies with FCC Form 47 Rules.

**Note: It is necessary to use a shielded power supply cable. You can than use the “shield contact” on the connector which has GND contact to the camera housing. This is essential for any use. If not done and camera is destroyed due to Radio magnetic Interference (RMI) WARRANTY is void!**

Operating temperature Spec:	-10 - + 45C. In order to keep dark current low. To achieve 9 optical bits, operation at 25° max. is recommended.
Power	US/UK and European line adapter can be delivered. Otherwise use +12V DC with filtered and stabilized power supply.
Shock test	About 30 g in 6 ms
Vibration test	10 g in 6 ms

**RoHS: All cameras comply with the recommendation of the European Union concerning RoHS Rules.**

### 13.11 Spectral response curves

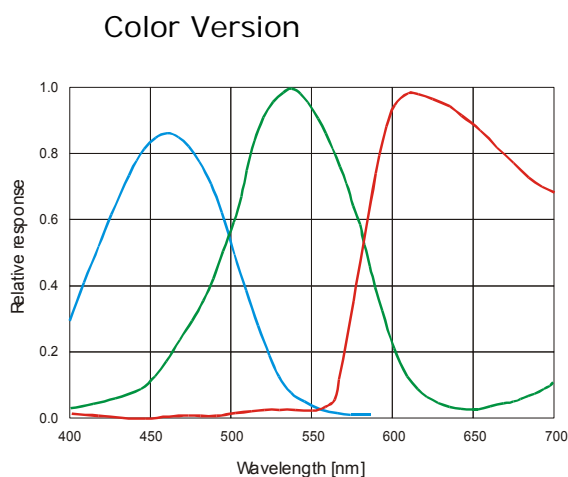
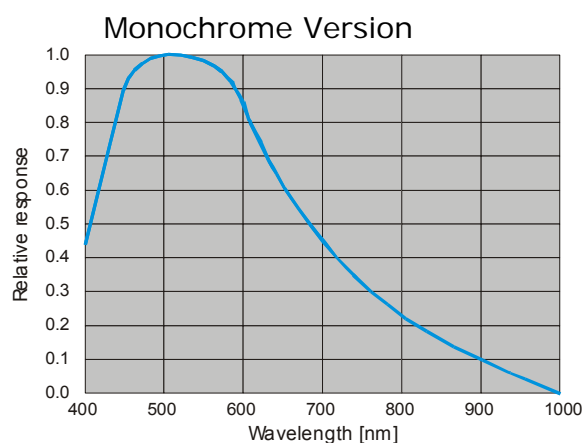



### 13.11.1 Comments on camera temperature

There is no need to worry because camera has been tested at higher temperature than specified (40 C°).

### 13.11.2 White Balance

In SVCapture White Balance will level out colors in order to create best possible image quality. This can be done manually and done inside the camera. If "Auto White Balance" is needed, please consult the Function calls in the SDK.

See next following paragraph: "Comments on Color Version"

**Note :** Due to IR contend in many light sources, the use of IR cut filter is essential. Otherwise "white balance" will not work well. This also true for outdoor applications.

## 13.12 Comments on COLOR Version

If you have purchased a COLOR version (e.g. svsZZZCXGEC) of this camera, please note the following:

In all electrical terms the camera is identical to the black and white versions.

The camera uses a CCD which has a color mosaic filter. This filter is called "Bayer" filter named after the person who invented it. It has a pattern on the lines which alternates as follows:

E.g.: First line: RGRGRG ... and so on. (R = RED, B = BLUE, G = GREEN)

Second line: GBGBGB ... and so on.

Please note that about half of the pixels are green, a quarter red and a quarter blue. This is due to the maximum sensitivity of the human eye at about 550 nm (green).

**Note that the green pixel in the "red" line has different sensitivity than the green pixel in the "blue" line.**

Because this camera is a single chip camera it is necessary to use an algorithm which interpolates those colors which are "not known" by the specific pixel. E.g. the red pixel does not know its green and blue components.

This means that the performance of the image depends on the software used.

Please be aware that it is not possible to incorporate the algorithm into the camera so easily. Unlike NTSC/PAL cameras there is no hardware chip available which can do that for such large images. The user has the advantage to alter the colors depending on his needs. Thus the color image must be processed in the PC.

We offer several algorithms in the SVCapture program which influence display rate and image quality. However a color source code is available on request for those who want to write an application.

We offer a complete set for a system setup containing camera, cable, power supply, and software to help solving your applications.

**Note that you can disable the color in the SVCapture program. Color processing is not done inside the camera but in the PC. So some CPU power is consumed.**

If you have questions do not hesitate to contact us or your local dealer.

## 5.1. Warranty Terms

Standard products warranty and adjustment.

Seller warrants that the article to be delivered under this order will be free from defects in material and workmanship under normal use and service for a period of TWO years from date of shipment. The liability of Seller under this warranty is limited solely to replacing or repairing or issuing credit (at the discretion for Seller) for such products that become defective during the warranty period. In order to permit Seller to properly administer this warranty, Buyer shall notify Seller promptly in writing of any claims,; provide Seller with an opportunity to inspect and test the products claimed to be defective. Such inspection may be on customer's premises or Seller may request return of such products at customer's expense. Such expense will subsequently be reimbursed to customer if the product is found to be defective and Buyer shall not return any product without prior return authorization from Seller. If a returned product is found to be out of warranty or found to be within the applicable specification, Buyer will have to pay an evaluation and handling charge, independent of possible repair and/or replacement costs. Seller will notify Buyer of the amount of said evaluation and handling charges at the time the return authorization is issued. Seller will inform Buyer of related repair and/or replacement costs and request authorization before incurring such costs. Buyer shall identify all returned material with Sellers invoice number, under which material has been received. If more than one invoice applies, material has to be clearly segregated and identified by applicable invoice numbers. Adjustment is contingent upon Sellers examination of product, disclosing that apparent defects have not been caused by misuse, abuse, improper installation of application, repair, alteration, accident or negligence in use, storage, transportation or handling. In no event shall Seller be liable to Buyer for loss of profits, loss of use, or damages of any kind based upon a claim for breach of warranty.

Development Product Warranty. Developmental products of Seller are warranted to be free from defects in materials and workmanship and to meet the applicable preliminary specification only at the time of receipt by Buyer and for no longer period of time in all other respects the warranties made above apply to development products.

The aforementioned provisions do not extend the original warranty period of any article which has been repaired or replaced by Seller. If Warranty Label of camera is broken Warranty is void!

SELLER MAKES NO OTHER WARRANTIES, EXPRESS OR IMPLIED, AND SPECIFICALLY, SELLER MAKES NO WARRANTY OF MERCHANTABILITY OF FITNESS FOR PARTICULAR PURPOSE.

# 14 Appendix A – Troubleshooting

## Get camera diagnostics

When clicking on the Camera | Diagnostics menu entry a dialog will open that allows for receiving camera diagnostics information.

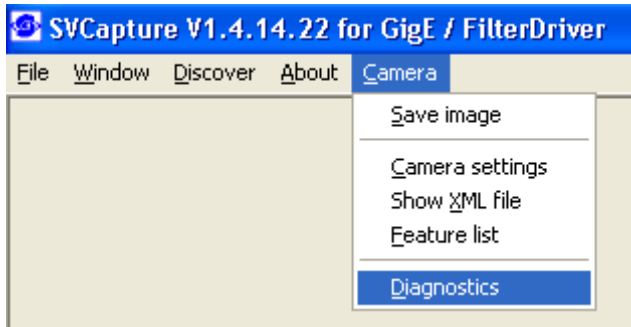

The content of the Diagnostics window is low level register information. Usually it is needed only for remote analysis purposes of problem situations.

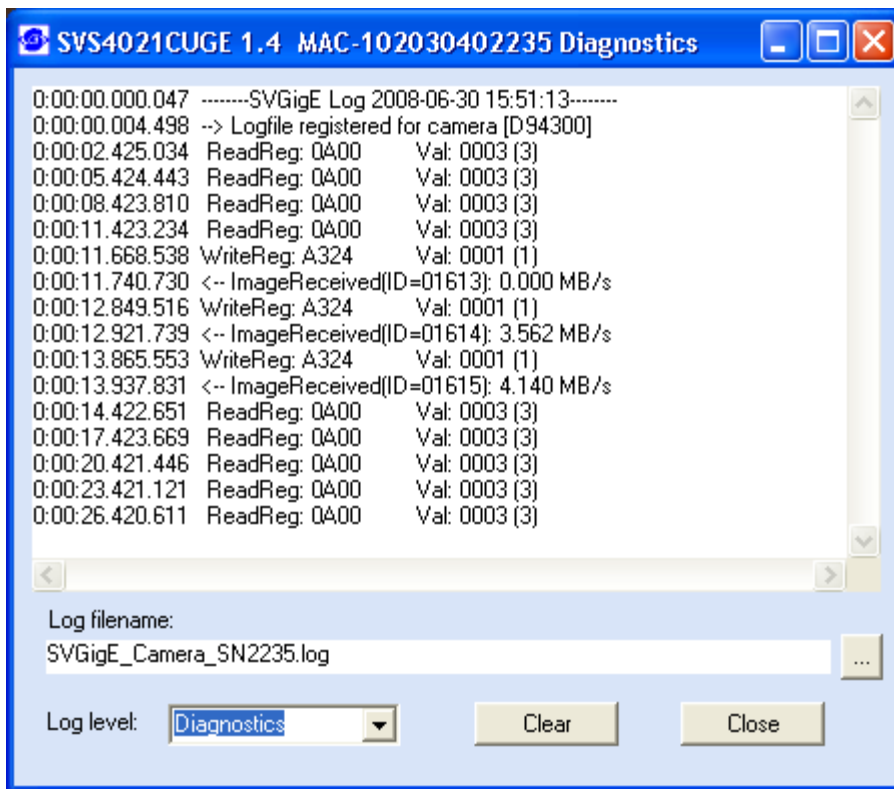

The following items provide some hints how to solve problem situations where a connection between a PC and a camera can not be established successfully.



**Send above in to your local support contact person if attempts to connect continue to fail.**

## 14.1 Problem: A camera does not appear in the discovery dialog

**Solutions:** Click on "Refresh" in order to repeat the Discovery action. Disconnect and reconnect the camera's power cable and repeat the Discovery action after a few seconds. Make sure the PC has got a valid IP address. Shutdown and restart the PC and repeat the Discovery action. Check firewall settings (See "Firewall considerations" below)

## 14.2 Problem: Camera image

**Problem:** A camera does not display a picture after it has been discovered and selected

**Solutions:** Force a valid IP address in to the camera using the dialog that comes up when right-clicking on an entry in the discovery dialog. Close the camera view and select the camera again in the Discovery dialog. Shutdown and restart the PC and select the camera again after discovery. Check firewall settings (e.g. disable firewall temporarily and select the camera again after discovery). Check if the processor speed of the PC is sufficient for displaying images at the chosen frame rate. If available, connect the camera to a different network card

**Problem:** No communication is possible between the camera and the PC.

**Solution:** Check if a firewall is active. This can prevent to establish any communication Because this is a network issue check firewall setting. Try to disable temporary the firewall and try again.

**Problem:** The video stream stops when adjusting the camera settings

**Solution:** This situation happens when the product between frame rate and exposure time becomes 1 second or greater. Any of the settings can be reduced in order to get the camera operational again. The exposure settings field will become red in order to signal that one of the frame rate or exposure setting has to be reduced.

**Problem:** Camera does not respond to light

**Solution:** Please execute following steps:  
Check if camera is in a "free running" mode. When done, check with "SVCapture" program if you can read back any data from the camera like: Type of CCD, S/N number exposure time settings and so on. If you trigger the camera by hardware: Check if the Trigger signal is present.



**The signal swing for must be minimum 9 V (max. 24 V) Source must provide 10 mA. Below such level the drivers in the camera will not work.**

**Check also the quality and swing. If these signals are not there or don't have the right quality (like spikes) the camera can not read out any frame or delivers distorted images.**

- Problem:** Image is present but distorted:  
**Solution:** Try different operation mode. Like if triggered gives bad results try "free running" mode and reduce frame rate to minimum half possible one. Check if you are using original "INTEL"® chip set in your PC! If problem still exist call your local support
- Problem:** The image of a color version camera looks "ugly" or false colors appear.  
**Solution:** If the raw image looks ok than pixel need to be shifted by either one or one line. The image color depends on the algorithm used. If the algorithm is starting with the wrong pixel such effects appear.
- Problem:** The colors of a color version are not perfect especially when using halogen light.  
**Solution:** Halogen light contains strong portions of IR radiation. Use cut off filters at around 730 nm like Schott KG 3 to prevent IR radiation reaching the CCD.
- Problem:** Only left connector of a 4 tap camera ( XX50) is connected. Camera is detected but no streaming.  
**Solution:** Use the RIGHT connector for only ONE GigE channel operation. Or Use both for Dual gigE operation and perform "Teaming" of 2 NIC ports. See Appendix.

### 14.3 TROUBLESHOOTING REQUEST LIST V1.3

Dear valued customer,  
in order to help you with your camera and any interfacing problems we request that you report a description of your problems when you use the camera. Please send answers to us:

1. Type of camera (e.g. svs11002XXGE)
2. Serial Number
3. Accessories used and where purchased or self made
  - a. Power supply
  - b. Cable
  - c. Lens type and focal length
4. Firmware version as well as operation mode, (send screenshot of SVCapture program)
- 5. DIAGNOSTICS SCREENSHOT AS ABOVE plus "log file"**
6. Description of the phenomena, e.g.:
  - a. missing lines or columns
  - b. distorted or noisy image (if possible send jpg image)
  - c. solarization effect
  - d. missing bits, contrast less image
7. PC used., Chip Set/Brand and type of Ethernet card
8. Operating system used e.g. WIN7 or XP 32 or 64 bit OS

## 15 Appendix A – Basic timing for different operation modes

### 15.1 Free running

A frame is readout automatically. There is no need to trigger the camera in order to get data. The enclosed software allows the user to set exposure time in  $\mu\text{Sec}$ . The time set stays resident after power off if the configuration is saved to camera if stored before.

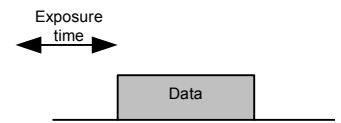

### 15.2 External Trigger and Pulsewidth of Trigger

In this mode the camera is waiting for an external trigger which starts integration and read out. Exposure time can be varied using the length of the Trigger pulse (I. E. between the high going edge and the low going edge). The time settings in the control software are not activated. This mode is useful in applications where the light level of the scene changes during operation and the framegrabber can provide such a signal. Change of exposure time is possible from one frame to the next.

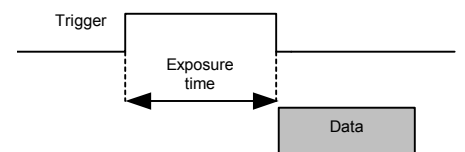

### 15.3 External and Software trigger and internal exposure time setting

The framerate is determined by the number of Trigger pulses per time unit. With each positive transition (going high) the camera will readout a frame. Exposure time is set in the same way as in the free running mode. Exposure time can be changed online during operation. The time set stays resident after power off, if the configuration is saved to the camera.

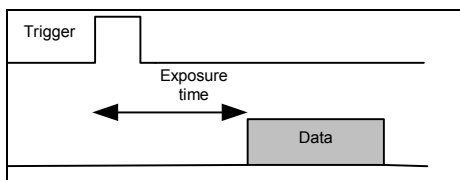

## 16 Appendix B

- **Automated SVGigE Filter Driver installation**

SVCapture checks on start-up, whether a SVGigE filter driver is installed. If this is not the case then the user will be asked whether a filter driver should be installed automatically. An information is given that network connections will shortly be interrupted:

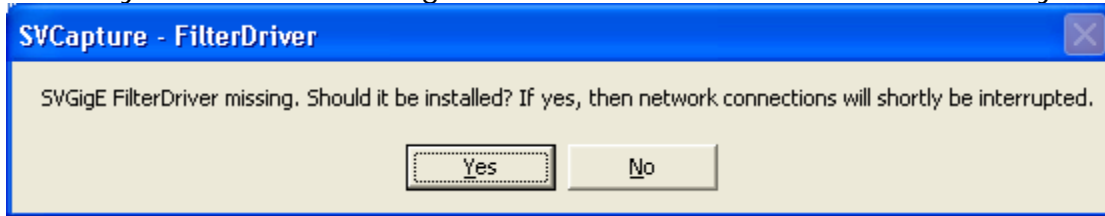

Alternatively, a FilterDriver installation can be started from menu:

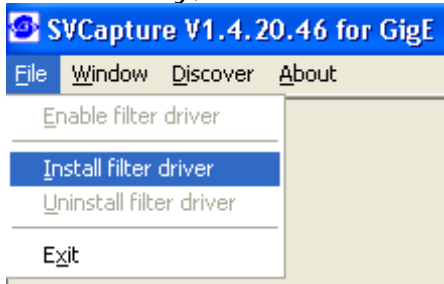

The user will be informed about a short network interruption:

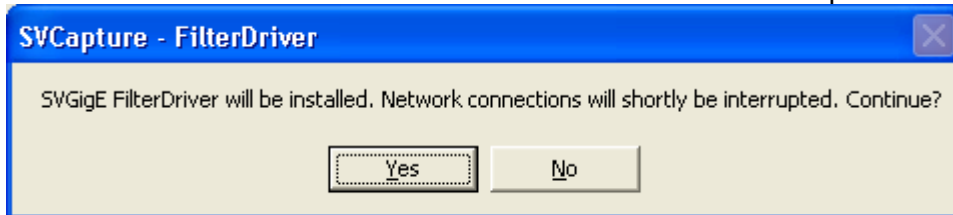

For both variants, the user will be asked for confirming warning dialogs:

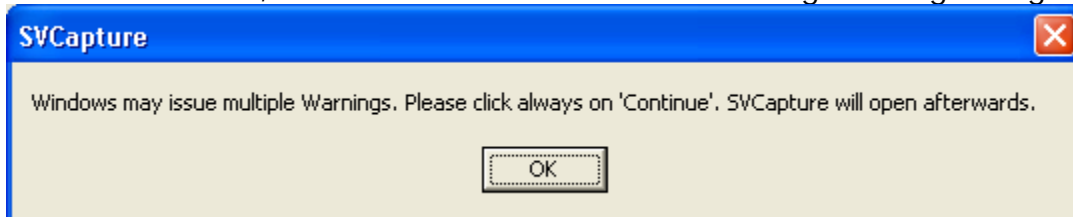





After some time, the driver will be installed and a message informs about success:

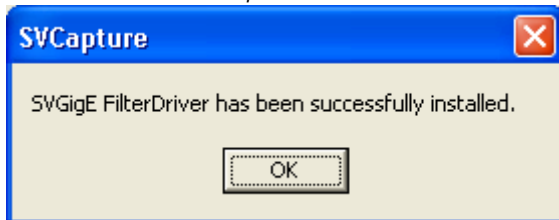

- **Automated SVGigE Filter Driver de-installation**

Please go to the File menu and select "Uninstall filter driver" for starting an automated SVGigE FilterDriver de-installation. Before, the filter driver has to be disabled with the "Disable filter driver" menu entry if needed.

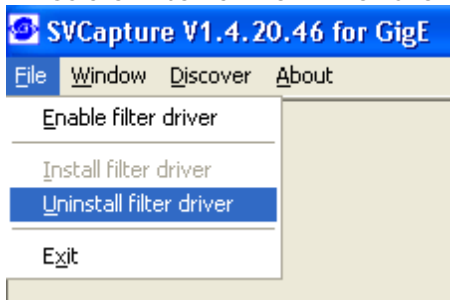

The user will be informed about a short network interruption during de-installation of the filter driver:

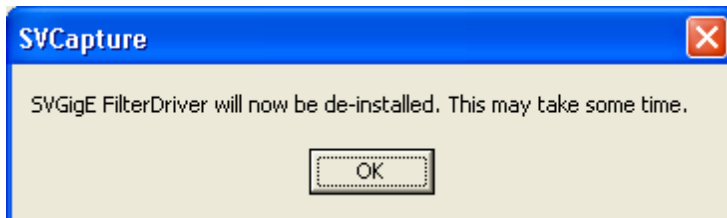
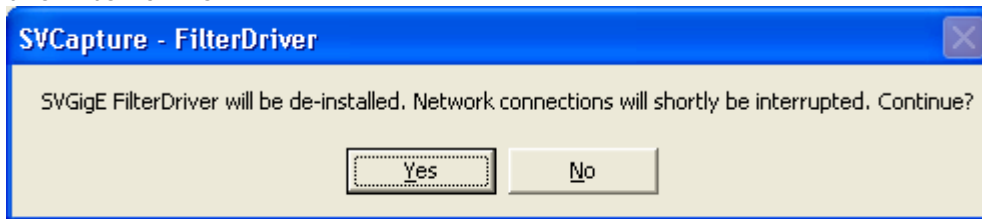

After some time, a message will inform about successful de-installation:

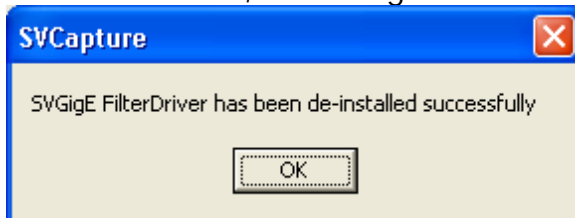

Subsequently, a Winsock transport layer is loaded in order to operate cameras without a filter driver. This mode of operation is not recommended.

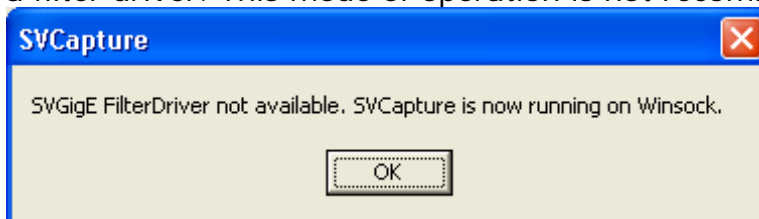

**NOTE: The SVGigE FilterDriver should always be installed. De-installation should only take place when the SVCam GigE SDK is intended to be de-installed on a PC.**

**SVS-VISTEK takes no responsibility for 3<sup>rd</sup> party drivers**

# Manual SVGigE FilterDriver installation

## 16.1 Installation Instruction for Filter Driver installation

In order to use the SVS GigE driver it has to be installed first. The setup will copy the driver to disk but will not install it. On a standard Windows XP/ Win 7 system this has to be done by the following steps:

**Hint:** Usually the driver will be copied by the setup procedure to the following location:

**C:\Program Files\SVS-VISTEK GmbH\SVS GigE SDK 1.4.X\SVS GigE FilterDriver**

## 16.2 Step-by-step

**Step 1:** Open the Network Connections dialog

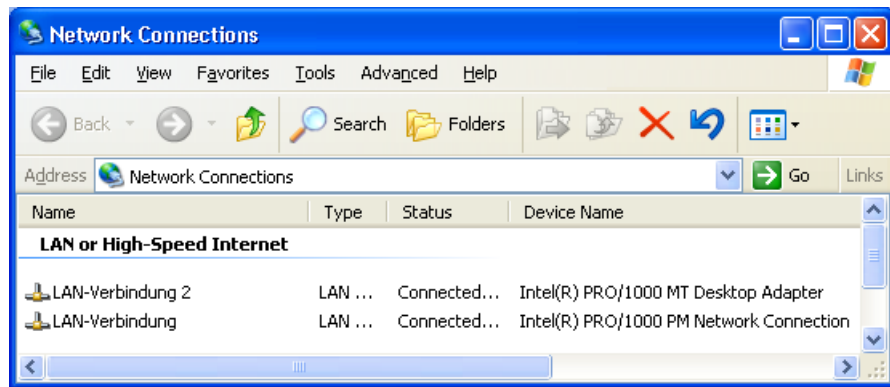

**Step 2:** Open the Properties dialog for LAN connections and click on "Install ..."

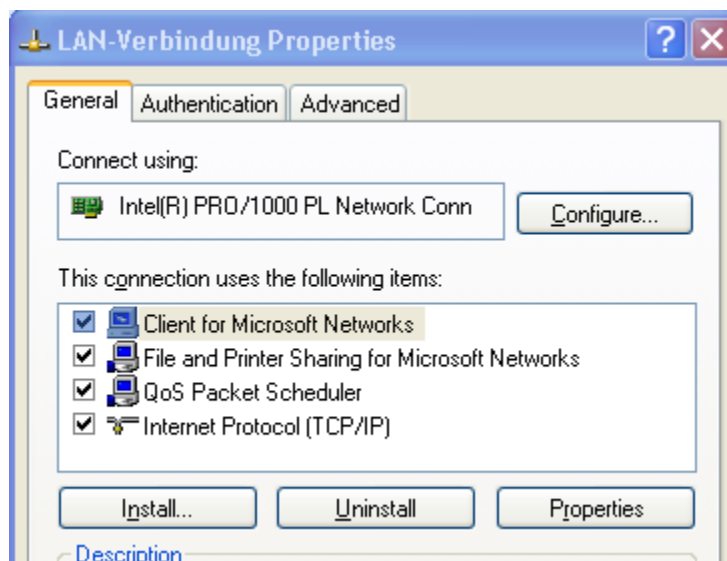

**Step 3:** In the "Select Network Component Type" dialog select the Service option and click on "Add ..."

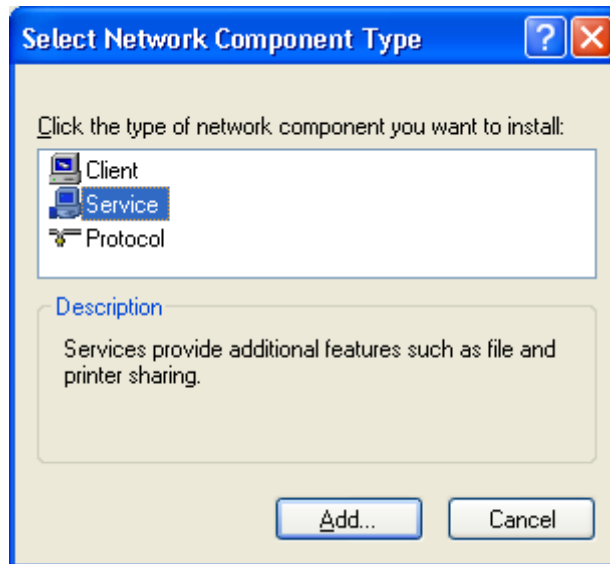

**Step 4:** In the "Select Network Service" dialog click on "Have Disk ..."

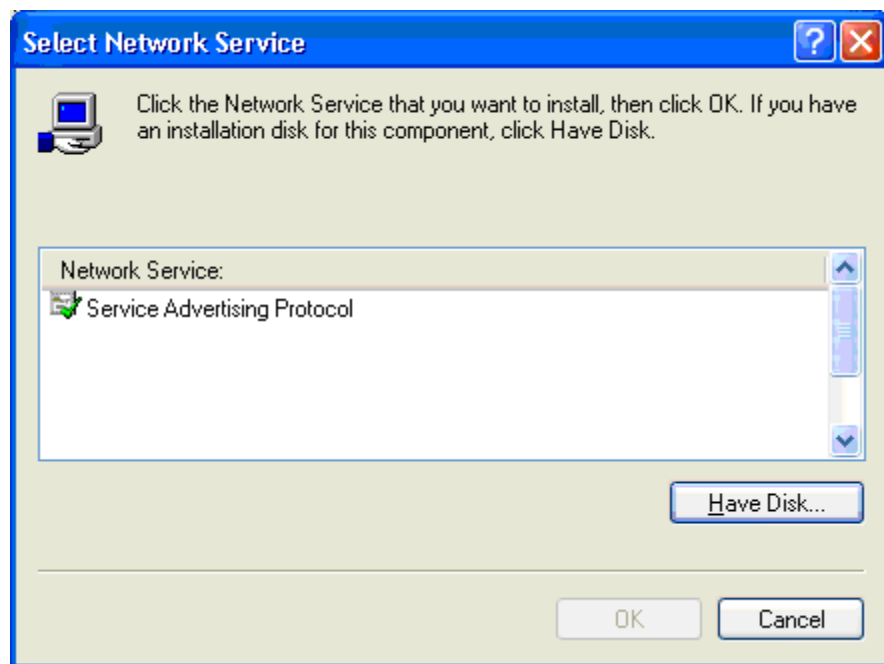

**Step 5:** In the "Install from Disk" dialog the folder where the driver files are located needs to be navigated to or entered directly into the files field.

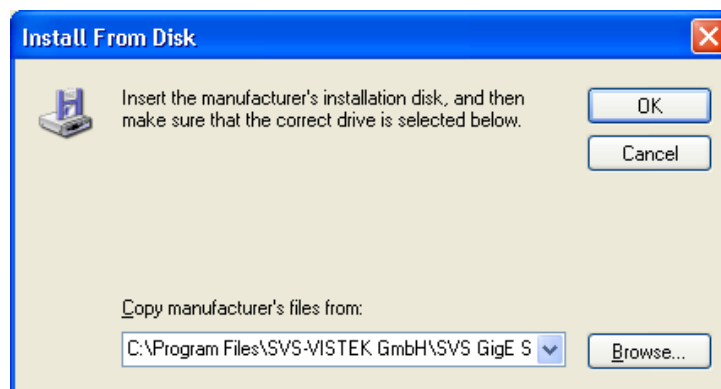

**Step 6:** After clicking on OK the "Select Network Service" dialog will display a message that the driver is not digitally signed. Click on OK.

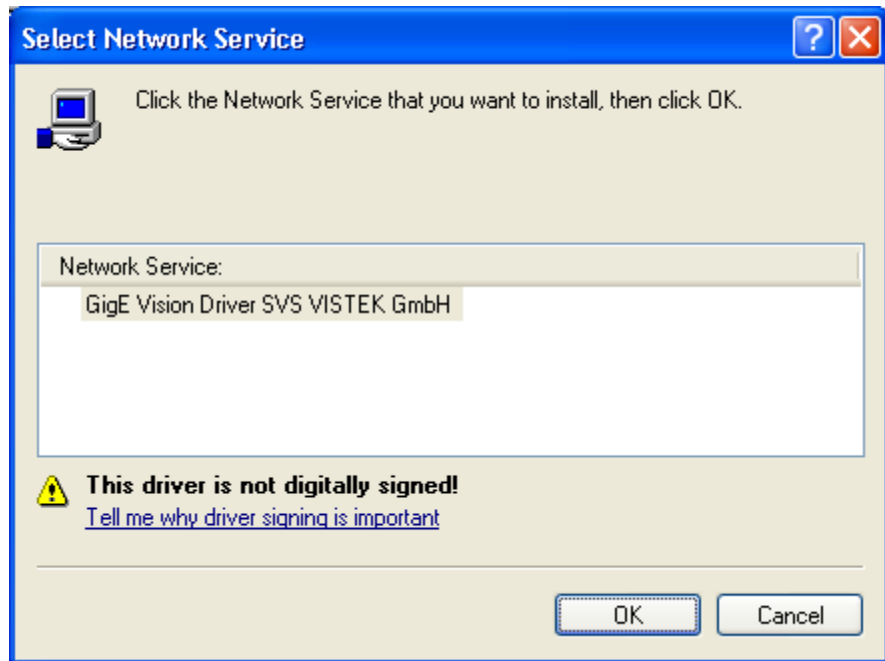

**Step 7:** Because the driver not being digitally signed, a dialog will appear with a warning. Answer with "Continue Anyway" as often as needed.



**Step 8:** After confirming the prior dialogs the driver is installed and should show up as a new item in the “LAN Connections Properties” dialog.

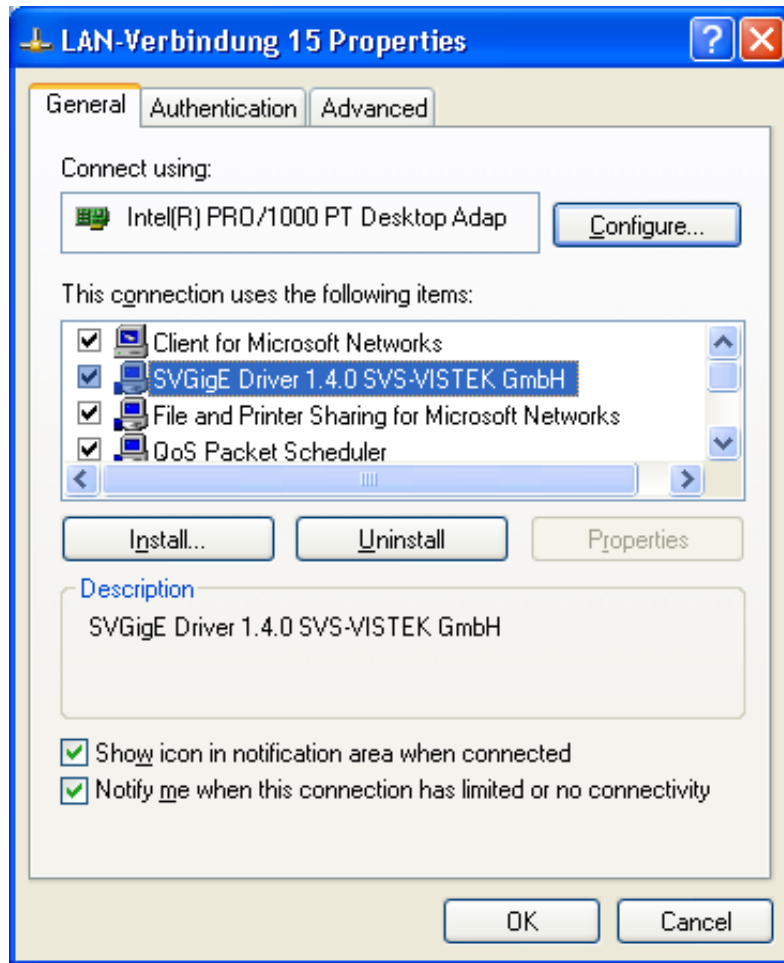

**Step 9:** The dialog can be closed and the “GigE Vision Driver SVS-VISTEK GmbH” is ready for use. The main dialog in SVCapture will show an extension “FilterDriver” which indicates that the driver will be used next time when opening a camera. If this extension is not shown it can be activated in the “File | Enable filter driver” menu item.



**Step 10:** Follow „Displaying Live Images” in this documentation in order to see live video. If the driver was successfully installed and works properly the extension “FilterDriver” will remain in the main dialog’s caption. Otherwise it will disappear and the SVCapture program falls back to operating the GigE Vision camera over WinSock.

## 17 Appendix C

### Setting Static Link Agregation (SLG) on Intel Pro 1000 Dual port NIC card

Note that you must have ADMIN rights in order to do this under Win 7

Open Network Connection dialog

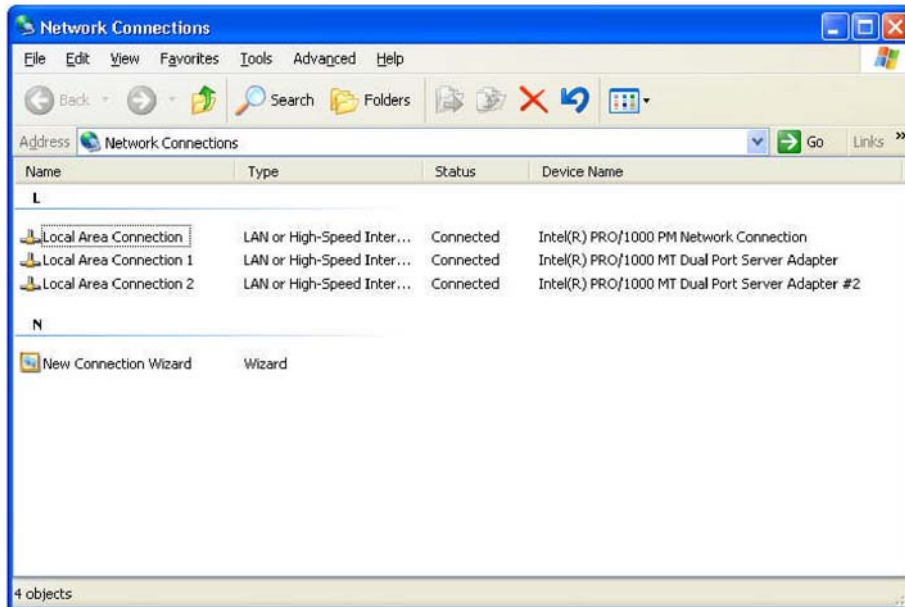

Open context menu on a Server Adapter Connection and select Properties





Select configure and than Teaming tap

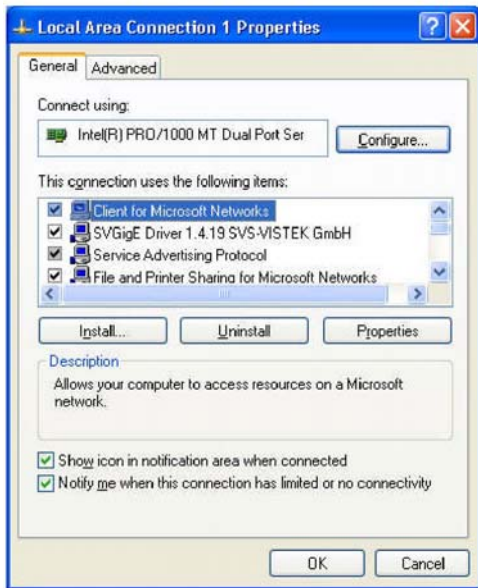

Select teaming tap

Choose Team with other adapters and press New Team

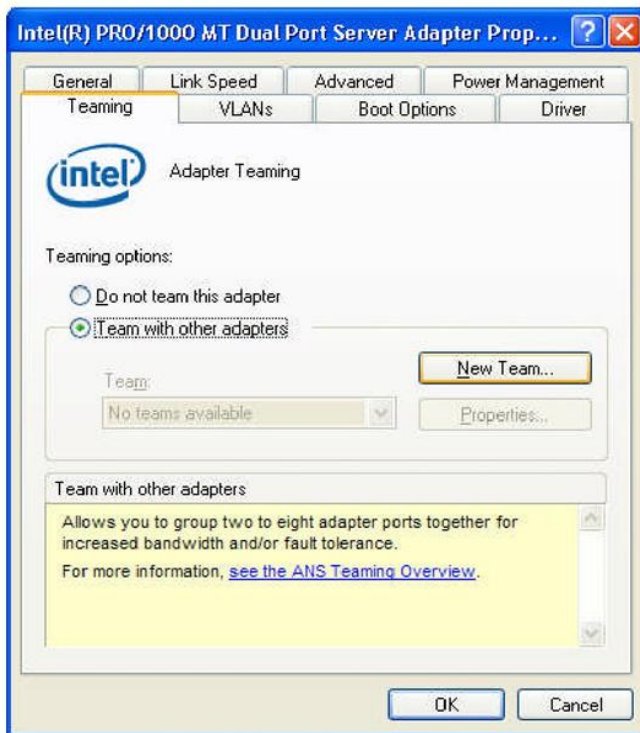

Press next



Select both adapters from Dual port server adapter

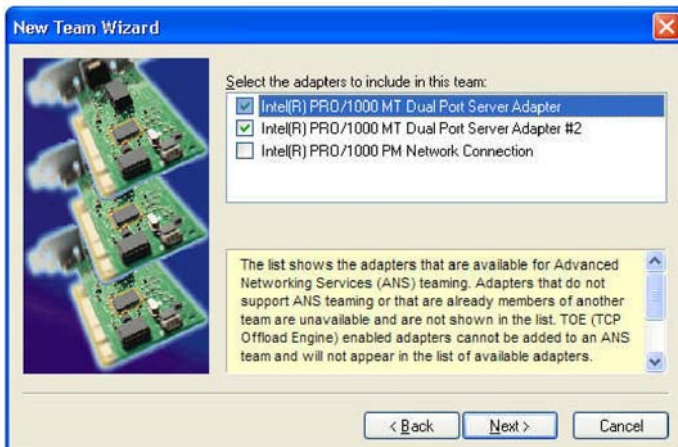

### Choose Static Link Aggregation

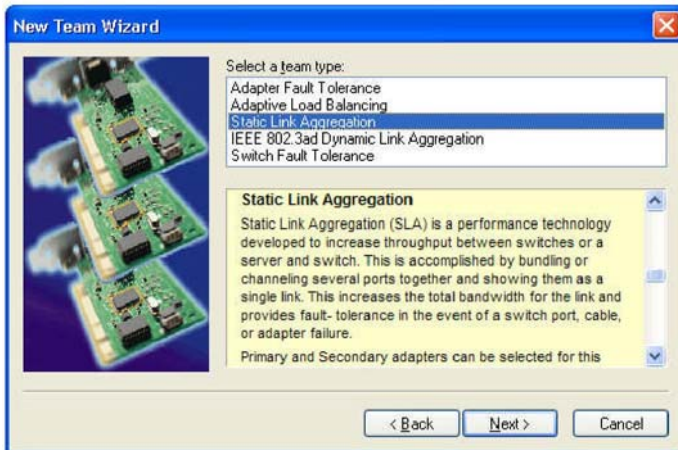

### Press finish

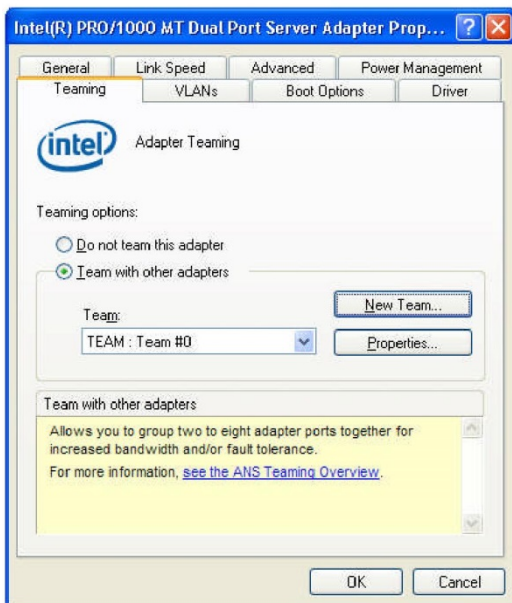
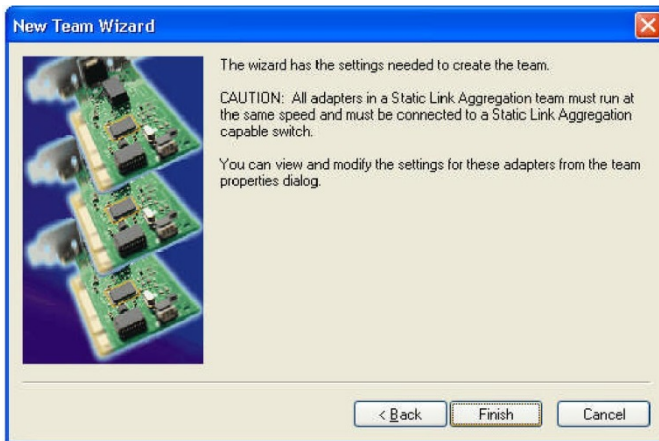

### Adapter teaming is done

Change to advanced tab, set Jumbo frames to 16128 byte and press OK

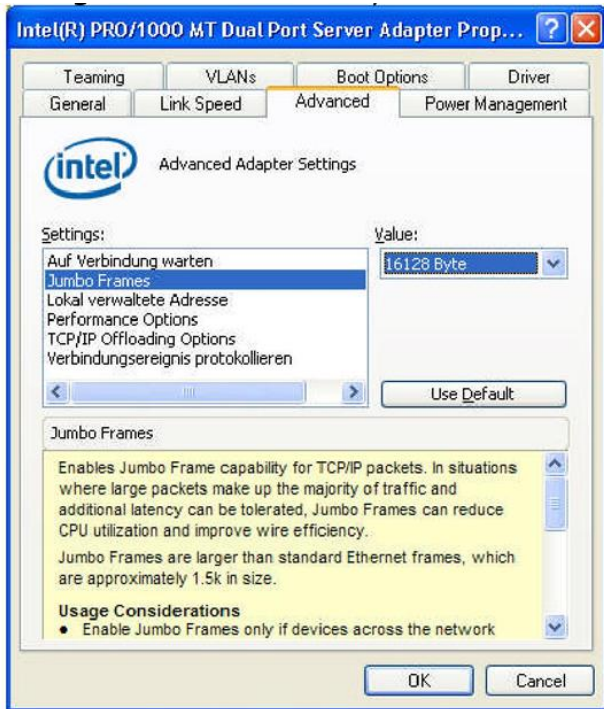

Back to Network connections window, a new connection is created

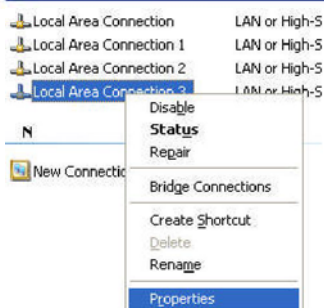
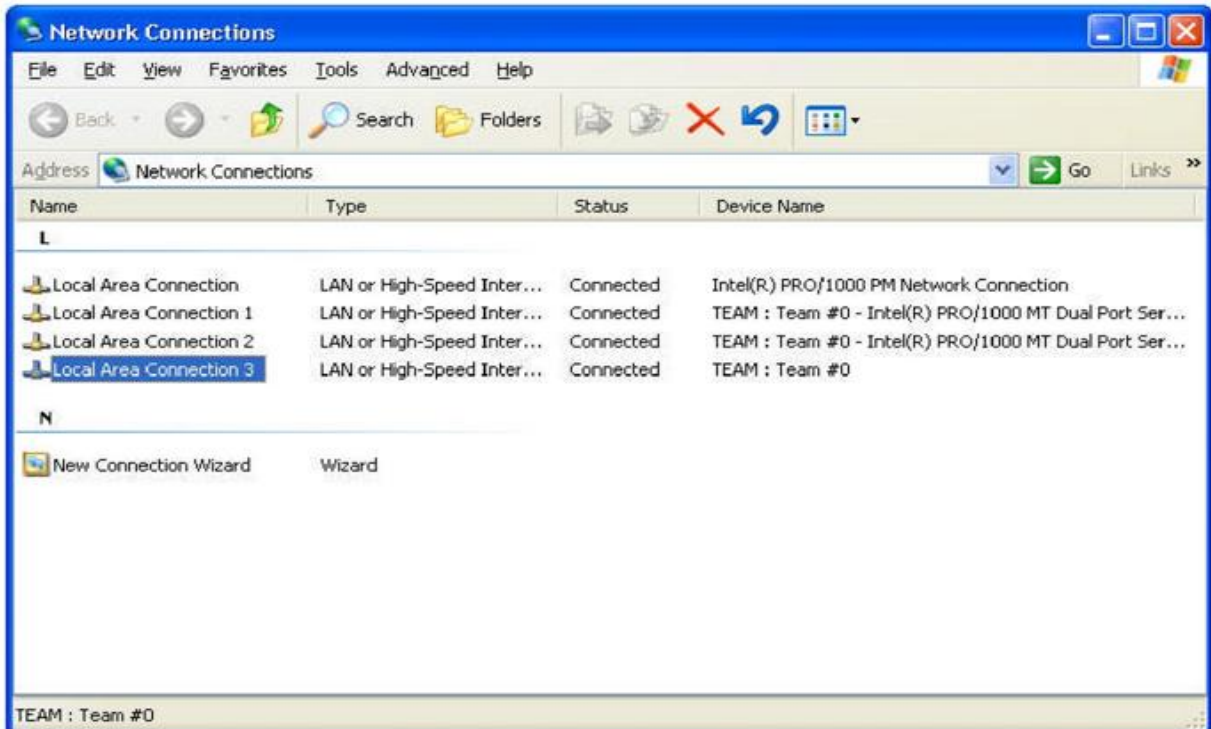

Open context menu and open properties.



Choose Internet Protocol (TCP/IP) and click Properties

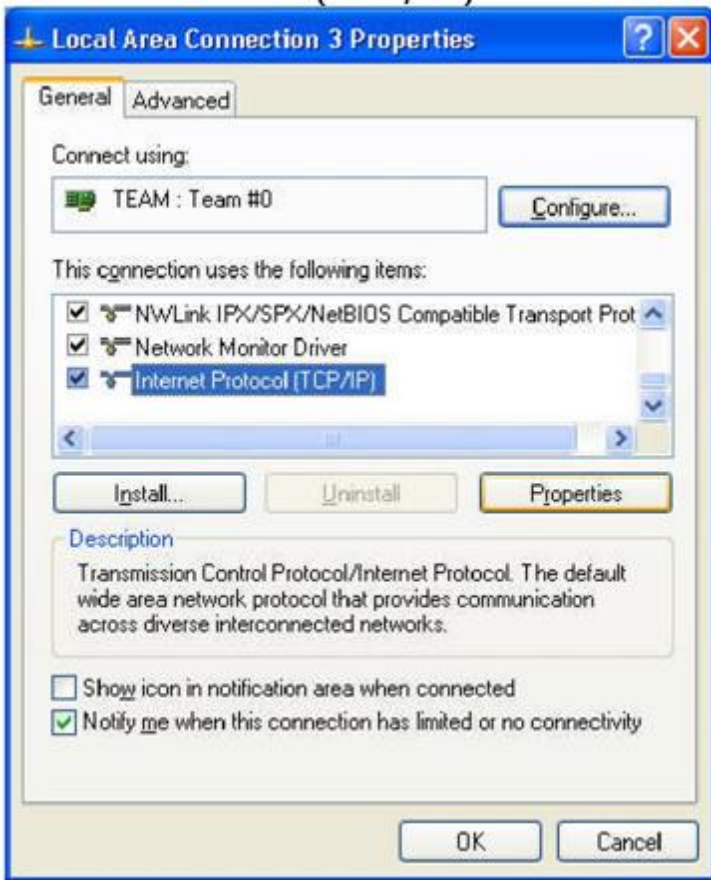

Setup IP address and Subnet mask and press OK

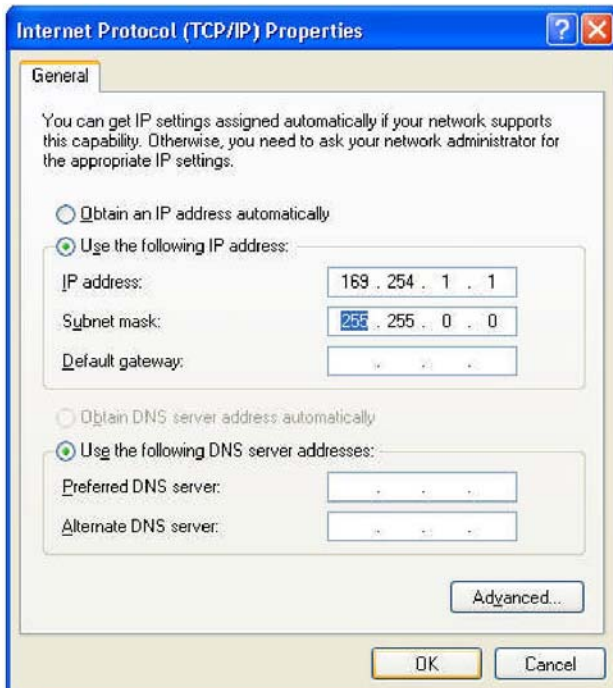

Press OK

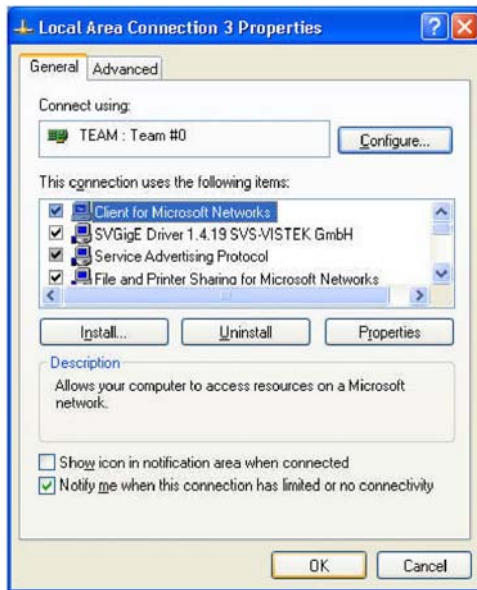

You are done !!

## 18 Appendix D

### 18.1 PC and OS Requirements

It is recommended to use a PC with a Intel i5 or i7 Dual core processor or higher. In case of svs29050 a quad core CPU is recommended. The camera is working also with lower frequencies but in those cases it might not deliver the full framerate. The operation system must be XP or Win 7. We don't support WIN 98/NT/2000 or older Operation systems. Linux driver is available, but require experienced user. Same is true for other OS, like VXworks.

#### 18.1.1 Firewall considerations

The GigE Vision standard defines a communication based on UDP packets between a GigE Vision compliant camera and a host PC. Often PC firewalls are adjusted to be restrictive and not to allow for sending UPD packets from the outside of the PC to a port that has been opened by an application

Sometimes the firewall settings have been adjusted during installation of the operating system or afterwards such that the user will be asked if the UDP data stream should be enabled once a camera starts sending UDP packets to the PC. When clicking OK in response to that question the application will be added to a list of exceptions. A firewall will let those applications communicate with network devices like a

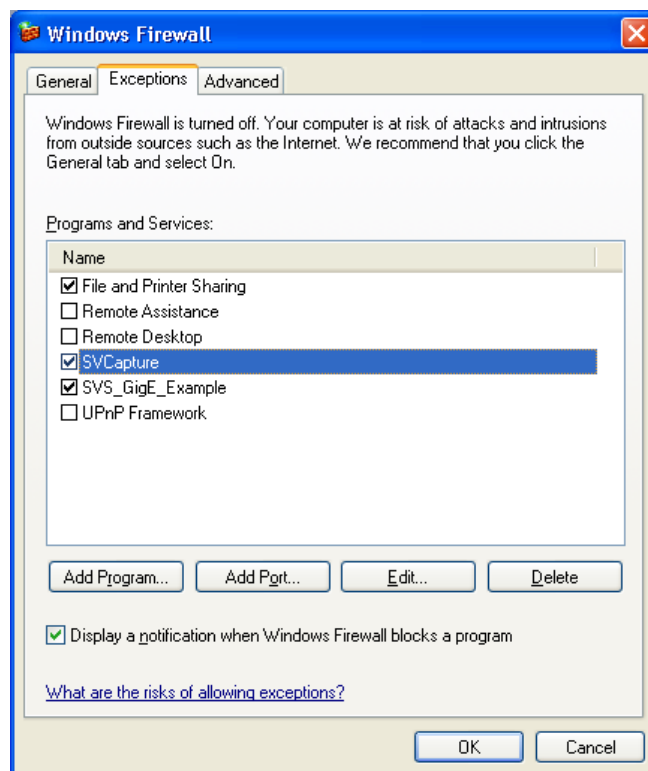

GigE Vision camera over the network. In case the Windows installation has been adjusted such that the user will not be asked when an outside device starts sending network packets to an application then that application has to be enabled manually in order to achieve the same as before. An appropriate dialog can be opened for example when right-clicking on the network icon in the tray and selecting "Change Windows". After clicking on the "Add Program ..." button the GigE Vision application can be searched for in a file explorer and it will be added to the list of Exceptions in the above dialog. Henceforth the communication to the GigE Vision compliant device will be enabled.

## 19 Appendix E

### 19.1 Firmware-Update with "GigE Update Tool.exe" program

**Note:** In order to work with the latest driver and SVCapture it might be necessary to **UPDATE** the firmware inside the camera. This can be done in the field. It is usually not necessary to send the camera in.

**This program can also be used (after and including Version 1.4.23.61-1) to DOWNGRADE a camera in case to make the camera work for older driver version.**



#### Warnings:

- **Camera must have power**
- **Camera must be accessible from PC via network**
- **Camera SHOULD NOT be used during programming procedure**
- **Camera SHOULD NOT be disconnected during programming procedure or be disconnected from network**
- **Programming software SHOULD NOT be stopped during procedure.**

**It might take up to a minute until it is completed. Please wait.**

**Step1:** Locate „svgigeup.exe“ using Windows Explorer

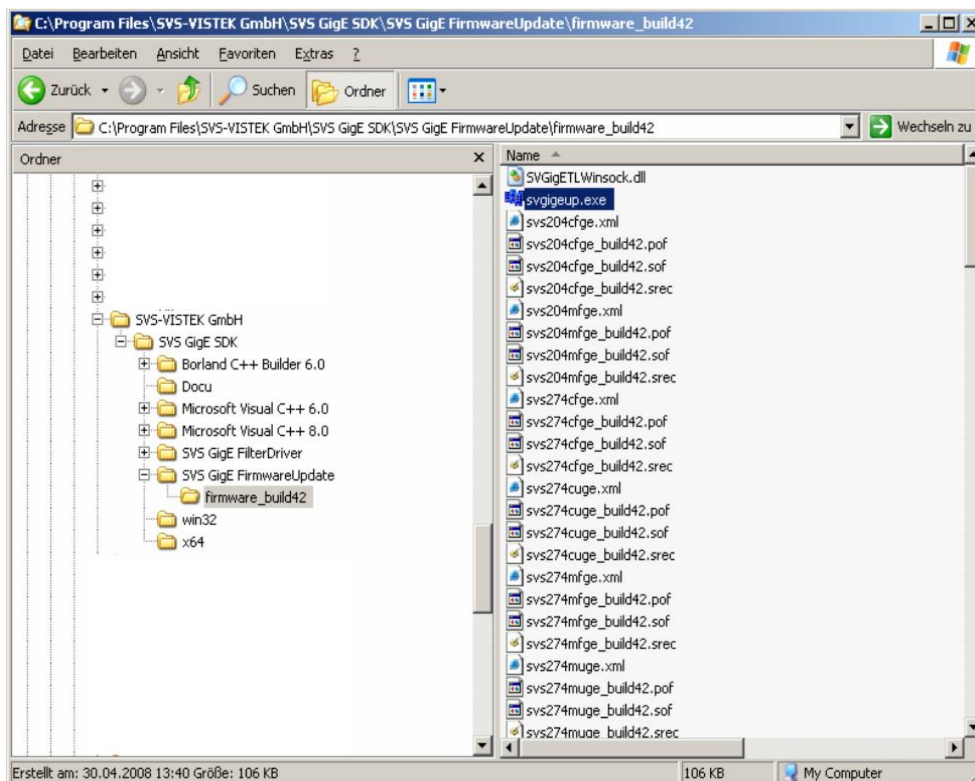

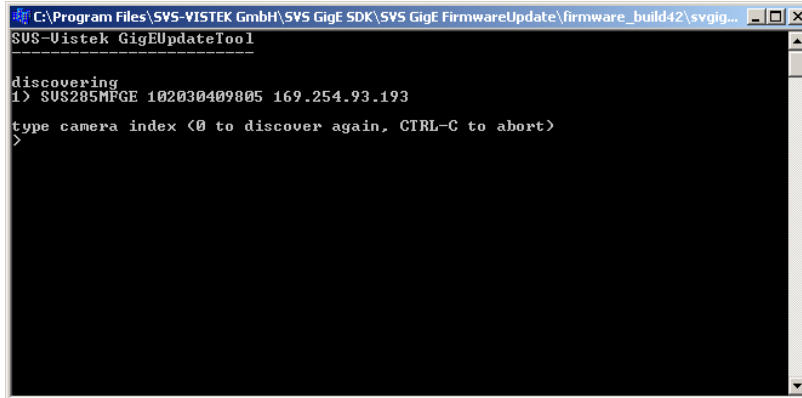

**Step 2:** Execute svgigeup.exe

```
C:\Program Files\SVS-VISTEK GmbH\SVS GigE SDK\SVS GigE FirmwareUpdate\firmware_build42\svgig...
SUS-Vistek GigEUpdateTool

discovering
1) SUS285MFGE 102030409805 169.254.93.193
type camera index (0 to discover again, CTRL-C to abort)
>
```

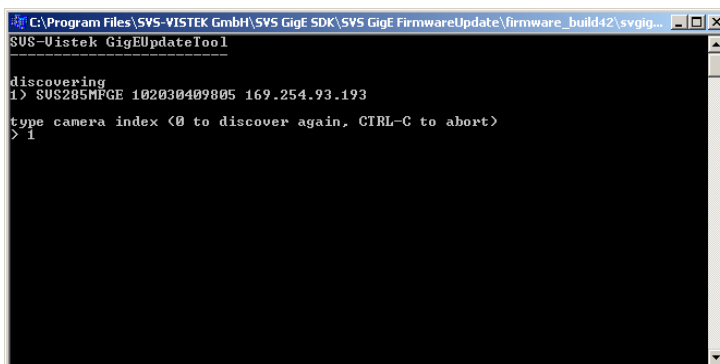
**Step 3:** Select Camera (e.g. 1 and press Enter)

```
C:\Program Files\SVS-VISTEK GmbH\SVS GigE SDK\SVS GigE FirmwareUpdate\firmware_build42\svgig...
SUS-Vistek GigEUpdateTool

discovering
1) SUS285MFGE 102030409805 169.254.93.193
type camera index (0 to discover again, CTRL-C to abort)
>1
```

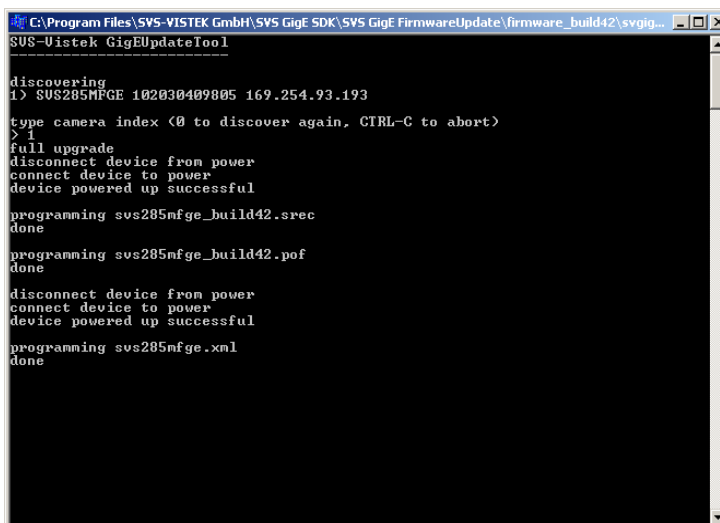
**Step 4:** Wait and follow instructions

```
C:\Program Files\SVS-VISTEK GmbH\SVS GigE SDK\SVS GigE FirmwareUpdate\firmware_build42\svgig...
SUS-Vistek GigEUpdateTool

discovering
1) SUS285MFGE 102030409805 169.254.93.193
type camera index (0 to discover again, CTRL-C to abort)
>1
full upgrade
disconnect device from power
connect device to power
device powered up successful

programming svs285mfge_build42.srec
done

programming svs285mfge_build42.pof
done

disconnect device from power
connect device to power
device powered up successful

programming svs285mfge.xml
done
```

**YOU ARE DONE!**

**After programming it is recommended to start the camera again. This means you have to disconnect power and – after some seconds – power up again.**

## 20 Appendix F

### Basic circuits for Hardware Interfacing

Example:

**Use Hardwaretrigger connection on N1**

**For Strobe use OUT1**

#### 20.1 For svs11002 and svs16000

#### TTL input circuit

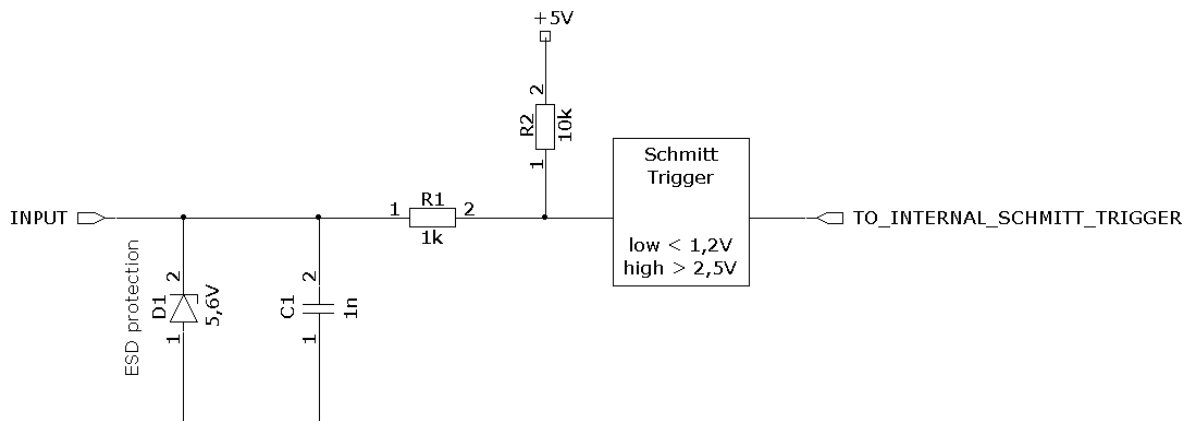

#### TTL output circuit

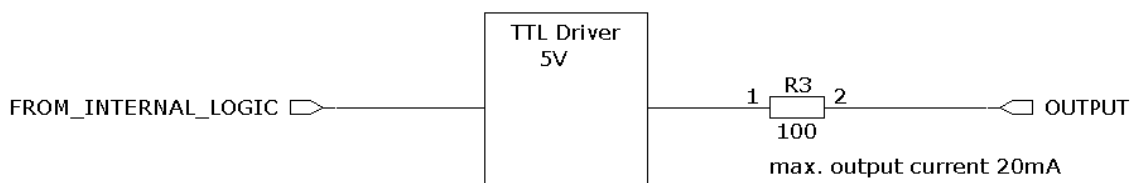

## 20.2 For hr16050, hr16070 and hr29050

### Use Hardwaretrigger connection on N1

### For Strobe use OUT1

Using In- and Output MOSFETS  
e.g to drive directly a LED light source

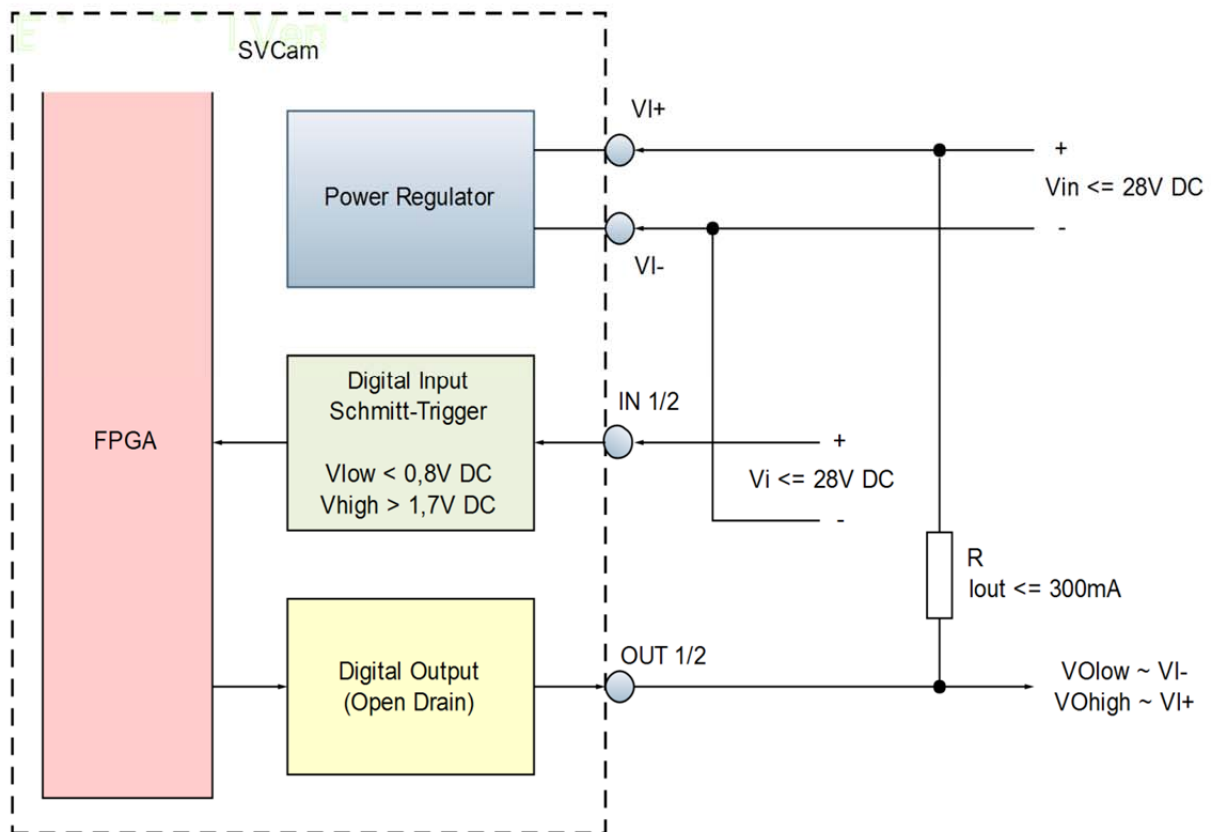

### 20.3 Safety Instructions

- This section contains important information for the operator (user) and/or people around him/her to avoid personal injuries, or property damages against him/her or people around him/her by using this product correctly.
- Prior to use, read this section carefully to fully understand its instructions for correct use.

Definition of markings





The meaning of each mark used in this instruction manual is given below

DANGER	This mark warns the user that improper use, indicated with this mark, may cause death or severe personal injuries against the user or people around him/her.
CAUTION	This mark warns the user that improper use, indicated with this mark, may cause personal injuries (*1) or material damages (*2) against the user or people around him/her.





Notes











\*1: Personal injuries mean wounds, burns, electric shocks, and others for which the person injured need neither to be hospitalized nor to be cared for the long term.





\*2: Material damages mean any direct or consequential damages related to property or material loss.

	<input type="checkbox"/> This mark indicates what the user SHOULD NOT DO. The details of things, which the user should not do, are described next to this mark.
	<input type="checkbox"/> This mark indicates what the user MUST DO. The details of things, which the user must do, are described next to this mark.
	This mark indicates that the user must be alert against a possible DANGER. The details of the DANGER, which the user must be aware of are described next to this mark.
	<input type="checkbox"/> This mark indicates that the user is given a CAUTION against possible hazards. The details of the CAUTION, which the user must be aware of, are described next to this mark.

Handling Precautions

	<b>DANGER</b>
	If any overheating sign is observed, discontinue the use immediately. In the event that smoke, smell, or any other overheating sign is observed, turn the power switch of the system OFF immediately and remove the power cable(s) from the system connectors, like computer, camera, lighting. Do NOT try to continue to use the system. To do so in spite of clear signs of malfunction invites a fire, an electric shock hazard, or a serious damage to the system components. In such case, contact for repair service us or our dealer/distributor, from which you purchased the system.
	<input type="checkbox"/> If any malfunctioning sign is observed, discontinue the use immediately. Do NOT try to use the system when it is malfunctioning. (Ex. No images on the monitor) In the event of malfunction, turn the power switch of the system OFF immediately and remove the system power cables from the system components connectors. In such case, contact for repair service us or our dealer/distributor from which you purchased the system.
	<input type="checkbox"/> If any foreign object gets into the system components, discontinue the use immediately. In the event that liquids, small particles, or any other foreign objects get into the system components, do NOT try to continue to use the system. To

	do so invites a fire or an electric shock hazard. In that case, turn the power switch of the system components OFF immediately and remove the system power cables from the system components connectors. After that, contact us or our dealer/distributor from which you purchased the camera for repair service/technical advice.
	<p>❑ Do NOT disassemble the system components.</p> <p>Do NOT attempt to pull apart; repair, or modify the system components on your own. To do so leads to a fire or an electric shock accident. Contact us or the dealer/distributor from which you purchased the camera for repair/modification.</p>
	<p>❑ Do NOT supply any power than specified.</p> <p>The system components are designed to work only under specified voltage. Do NOT attempt to drive the system components with the power other than specified. Operating the system components under power other than specified invites a fire or a electric shock hazard.</p>
	<p>❑ Do NOT use the system components in a high-humidity environment.</p> <p>Do NOT place the system components near a humidifier, or in other high-humidity environment. To do so may cause a fire or an electric shock accident.</p>
	<b>CAUTION</b>
	If the system components are operated in the electromagnetic field, there may be cases where noises (vertical, horizontal, or oblique stripes) may appear to a video output or causes other malfunctions. In that case, take preventive measures on the electromagnetic-wave generating source so that the system components do not receive the interference by the electromagnetic-wave. Take extra precautions against electromagnetic-wave-interference if the system components are used with a servomotor, inverter, or other electromagnetic-wave-generating equipment.
	Avoid giving a strong shock against the system components. If your system components are used in the system where the connector are subjected to strong repetitive shocks, the connector are possible to break down. If you intend to use your system components in such a situation, make sure to use an optional-connector-fixing-hardware to connect the connector-plug to the system components body.
	<p>When the system components are not in use, put a lens or a lens-cap onto the cam head so that the image pickup plane of CCD is protected from dust, foreign object, or other flaw-causing object. If the glass plane (image pickup plane) gets dirty, clean it with a cotton swab. When it needs to be cleaned with a cleaner, be sure NOT to use any organic solvent other than ethyl alcohol. Do not clean the other system components. In such a case call us or the dealer/distributor from which you purchased the system components for cleaning or cleaning instructions.</p> <p>As a countermeasure against condensation, when the system components are moved from a warm place to a cold place, take appropriate precautions to prevent condensation from forming on the system components.</p>
	Do not pull strongly the any cable nor swing it. The stress from pulling or swinging may cause damage in the coating of the cable, or breaks in the inside wires.
	Avoid short-circuiting its signal output. Otherwise, the system components might be damaged.
	If too much amount of light, (= the incoming light amount of 100 times or greater in comparison with standard light) enters CCD image pickup plane, video output might not be obtained. In such a case, take measures to re-

	duce the amount of incoming light.
	Do NOT expose the camera to intensive light (sunlight, etc.) to prevent its inner CCD from getting damaged.
	When mounting a lens, take extra caution so that the lens is not tilted, nor does flaw exist at the lens-mount-screw part. Also check to confirm that neither dirt nor other foreign object is put inside. Improper mounting might cause the parts to become locked.
	<b>DANGER</b>
	Do NOT use any optional unit other than manufacturer-supplied one. We disclaim any responsibility for damages or losses incurred by user due to the use of unauthorized/unofficial option units supplied by a third party

**RESTRICTION FOR USE**

In case malfunction of this equipment (e.g. video output cut-off) can be expected to lead to significant accident, avoid using this equipment for such system integration use.

**CASES FOR INDEMNITY (LIMITED WARRANTY).** We shall be exempted from taking responsibility and held harmless for damages or losses incurred by user in the following cases. In case damages or losses are caused by fire, earthquake, or other acts of Gods, the act by third party, misuse by the user deliberately or erroneously, use under extreme operating conditions. In case indirect, additional, consequential damages (loss of expected interest, suspension of business activities) are incurred as results of malfunction of non-function of the equipment, we shall be exempted from assuming responsibility for such damages. In case damages or losses are caused by incorrect use, which is not in line with the instructions in this instruction manual. In case damages or losses are caused by malfunction resulting from band connection with other equipment.

In case damages or losses are caused by repair or modification done by the user.

**IMPORTANT SAFETY INSTRUCTIONS**

This device is designed and guaranteed to work under the temperature range of - 10 through 45 degree C. Avoid using the equipment beyond that limits.

Do NOT expose the camera's image-pickup-plane to sunlight or other intense light directly. Its inner CCD (charge-coupled device) might be damaged.

Do NOT exposure all system components to sunlight or other intensive light (UV, IR).

In the event that any abnormal condition is observed, turn the power switch OFF immediately. Do NOT try to continue to use the system components. To do so in spite of clear signs of malfunction invites a fire, an electric shock hazard, or any other serious damage to the system components. In such case, contact us or our dealer/distributor that you purchased the system components from for repair service.

To clean the body of this equipment, make sure to turn all power switches OFF first. To remove stubborn stains, use a soft cloth soaked in diluted acid free detergent. After that, clean with a dry cloth.

In case the image-pickup-plane should be settled with fine dust, dirt, or scratched, ask our distributor for technical advice