

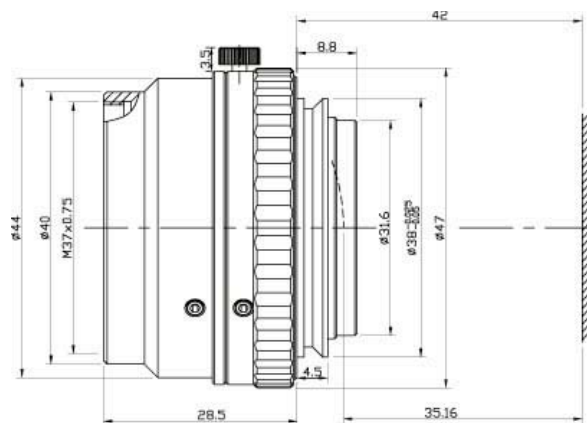

SPECIFICATIONS

Focal Length :	50mm
Format :	43.2mm
Magnification :	1/12X, 1/6X, 1/3X
Mount :	V
F/No :	2.8
Back Focus:	8.8
Max Image Circle :	46.2mm
Transmission :	400~1000nm
Distortion:	<0.4%, <0.01%, <0.4%
Working Distance:	638mm, 336mm, 185mm
Focusing Range:	39.32~43.44~51.78mm
Dimension:	∅44 x 28.5mm

Dimension



MTF Curves

>>Resolution: 10 L/MM ; 20 L/MM ; 40 L/MM

10 L/MM (sagittal) 20 L/MM (sagittal) 40 L/MM (sagittal)
 10 L/MM (tangential) 20 L/MM (tangential) 40 L/MM (tangential)

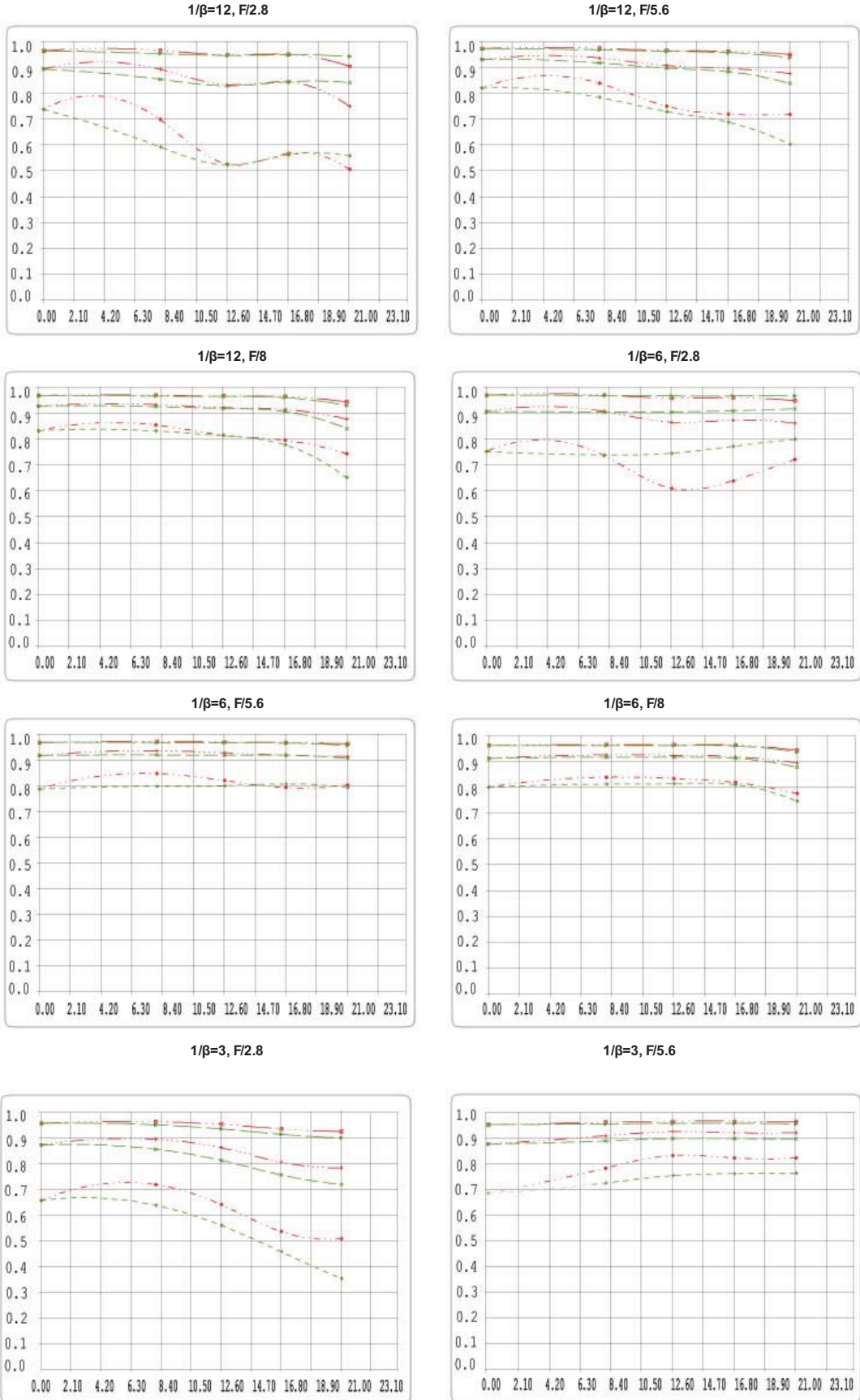

1/β=3, F/8

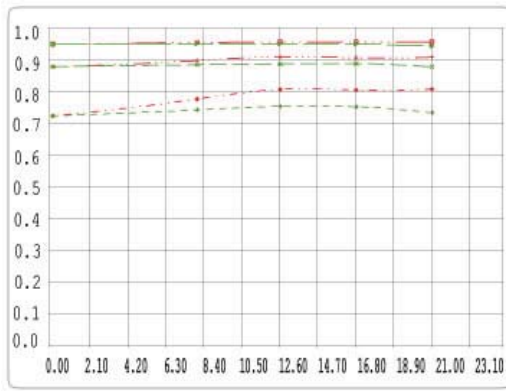

>>Relative Illumination

>>1/6X: red line ; 1/12X: Green line ; 1/3X: Blue line

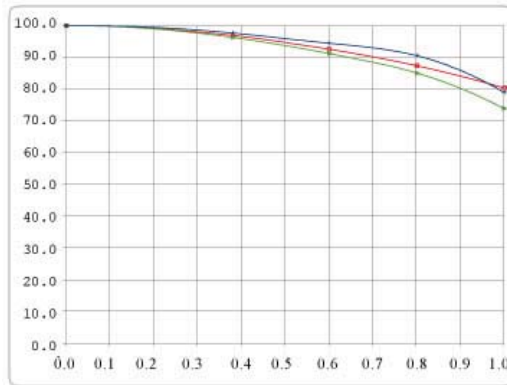
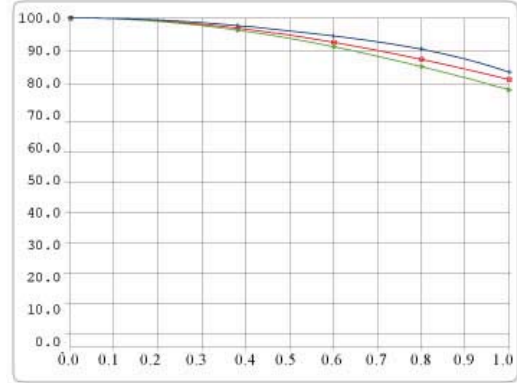
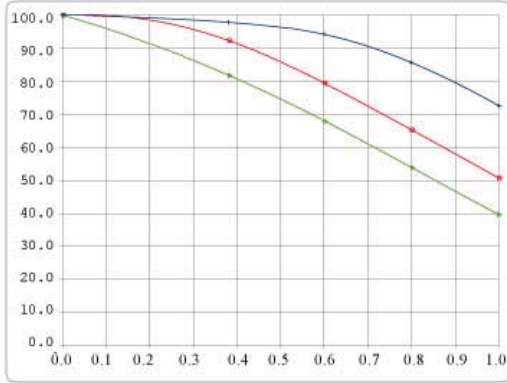

>>Distortion

1/12X

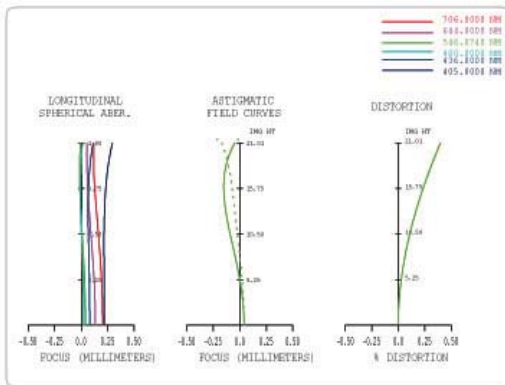

1/6X

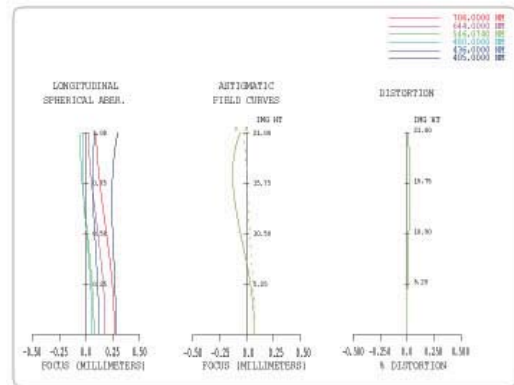

1/3X

