

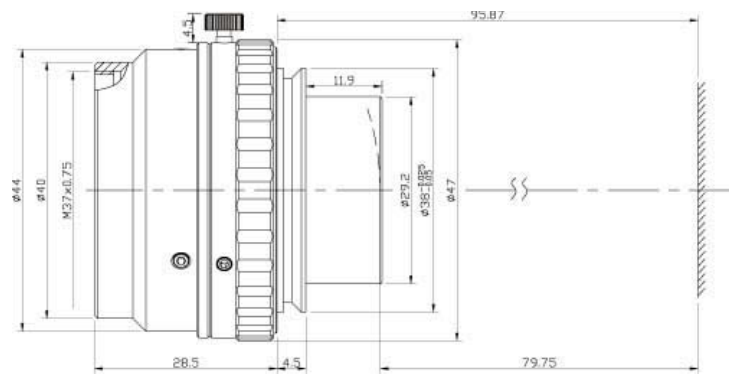

SPECIFICATIONS

Format :	100mm
Mount :	V
Focal Length :	100mm
F/No :	5.6
Magnification :	1/12X, 1/6X, 1/3X
Max Image Circle :	108mm
Distortion:	<0.2%, <0.1% <0.1%
Transmission :	400~1000nm
Working Distance:	1315mm, 700mm, 393mm
Focusing Range:	87.18~95.59~112.45mm

Dimension



MTF Curves

>>Resolution: 10 L/MM ; 20 L/MM ; 40 L/MM

- - - - - 20 L/MM (sagittal) - - - - - 40 L/MM (sagittal) - - - - - 10 L/MM (sagittal)
- - - - - 20 L/MM (tangential) - - - - - 40 L/MM (tangential) - - - - - 10 L/MM (tangential)

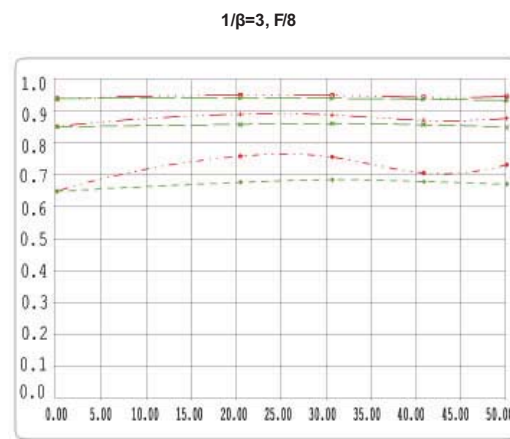
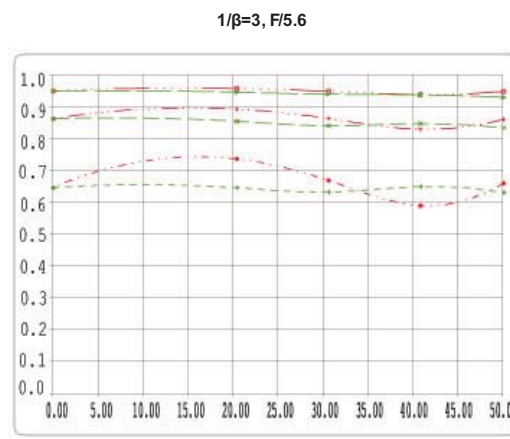
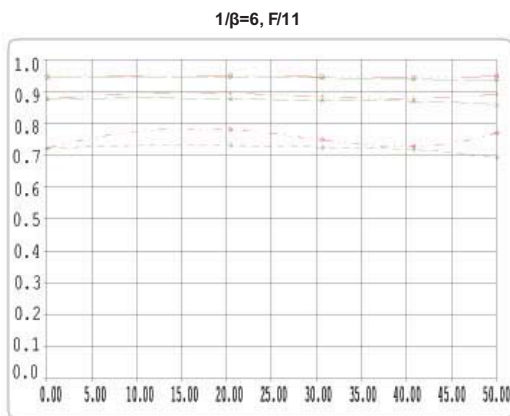
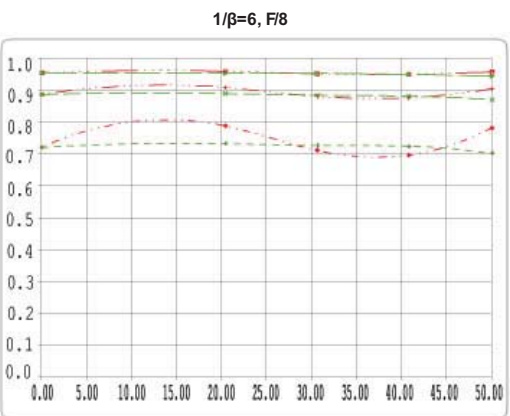
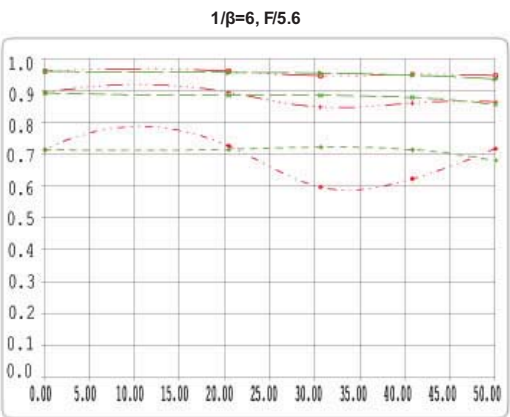
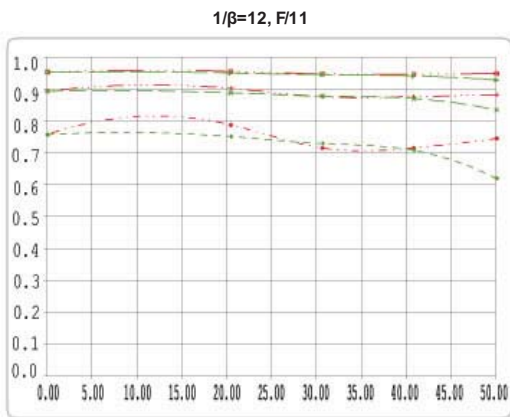
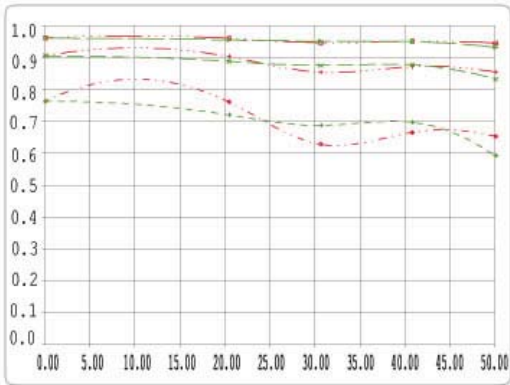
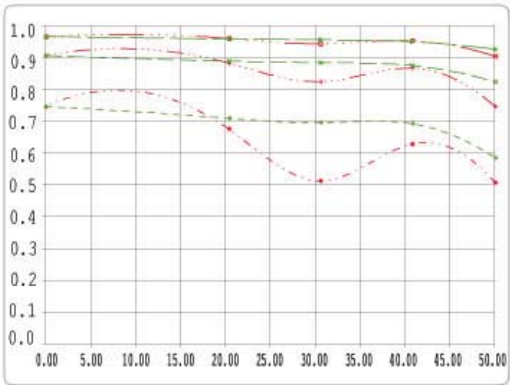

1/β=3, F/11

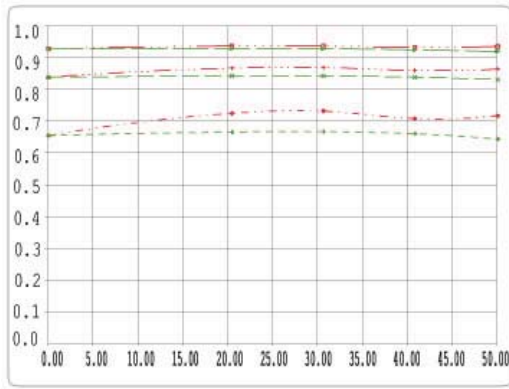

>>Relative Illumination

>>1/6X: red line ; 1/12X: Green line ; 1/3X: Blue line

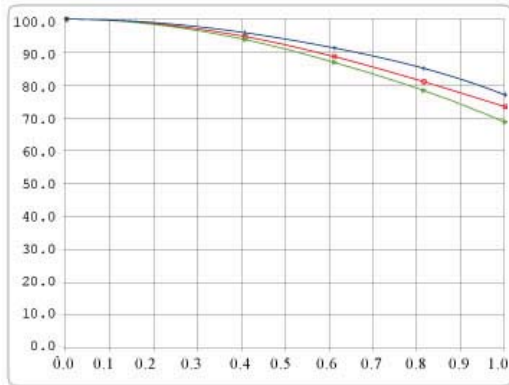
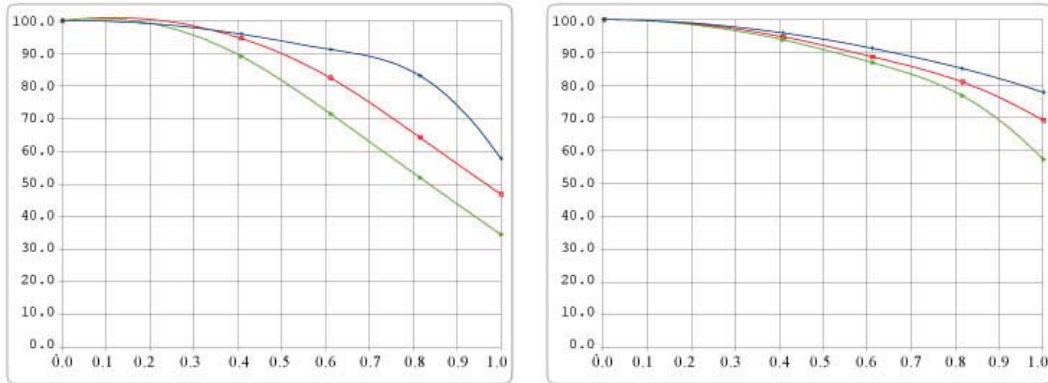

>>Distortion

1/12X

1/6X

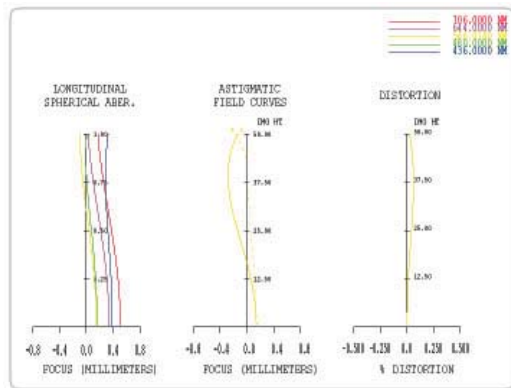
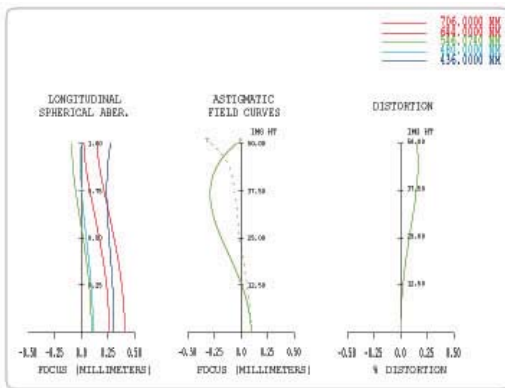

1/3X

