

XC-ST70/ST70CE XC-ST50/ST50CE XC-ST51/ST51CE XC-ST30/ST30CE

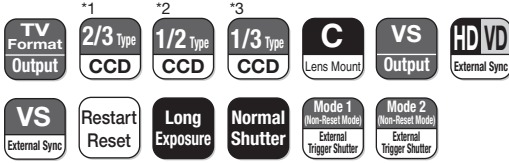

*1 : XC-ST70/ST70CE
 *2 : XC-ST50/ST50CE/ST51/ST51CE
 *3 : XC-ST30/ST30CE

Connection Diagram **PIA4**



Outline

The XC-ST Series cameras incorporate the latest CCD and signal processing technologies into a compact black and white camera module. A new external trigger design allows the electronic shutter speed to be freely specified by the width of an external trigger pulse or by a switch setting on the rear panel of the camera. These cameras are also user-friendly, with all switch settings located on the rear panel. Moreover, the XC-ST Series have the exact same dimensions, simplifying space requirements and making it easy to interchange them if necessary. These features, along with high picture quality and high shock and vibration tolerance make the XC-ST Series cameras ideal for demanding machine vision applications.

Features

- XC-ST70/ST70CE: 2/3-type IT CCD
- XC-ST51/ST51CE/ST50/ST50CE: 1/2-type IT CCD
- XC-ST30/ST30CE: 1/3-type IT CCD
- Small and lightweight: 44 (W) × 29 (H) × 57.5 (D) mm, Approx. 110 g
- Flexible trigger shutter functions
- High sensitivity
 XC-ST51/ST51CE: 0.2 lx (F1.4)
 XC-ST70/ST70CE/ST50/ST50CE/ST30/ST30CE: 0.3 lx (F1.4)
- 2:1 interlaced/non-interlaced (during external sync input)
- High S/N ratio : 60 dB (XC-ST70/ST50/ST51) : 58 dB (XC-ST30)
- Electronic shutter function (1/100 sec to 1/10,000 sec)
- Synchronization: internal/external (HD/VD, VS)
- Frame/Field exposure
- Restart/Reset function
- High shock and vibration tolerant

Accessories

- Compact camera adaptor
 - DC-700/700CE
- 12-pin camera cable (CE standard)
 - CCXC-12P02N (2 m)
 - CCXC-12P05N (5 m)
 - CCXC-12P10N (10 m)
 - CCXC-12P25N (25 m)
- Tripod adaptor
 - VCT-ST70I

Dimensions

Camera body of all XC-ST models

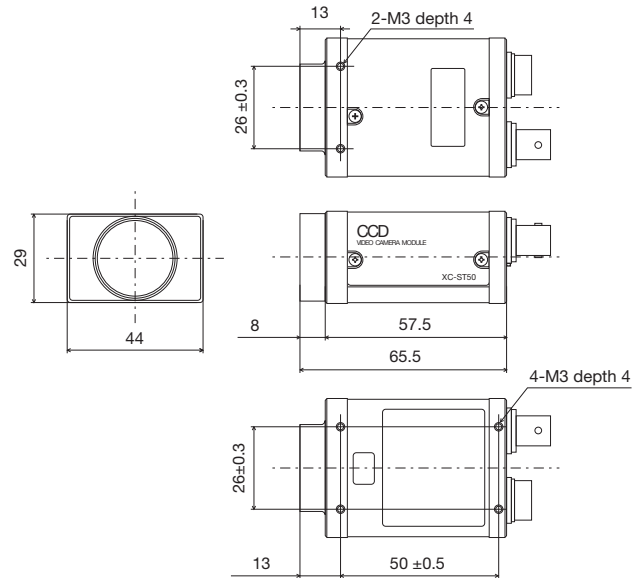

Unit: mm

Spectral Sensitivity Characteristics

• XC-ST70 (Typical Values)

Relative sensitivity

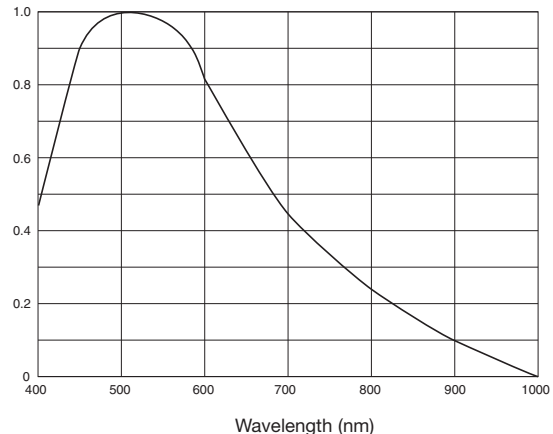

(Lens characteristics and light source characteristics excluded.)

• **XC-ST50/XC-ST51/XC-ST30**
(Typical Values)

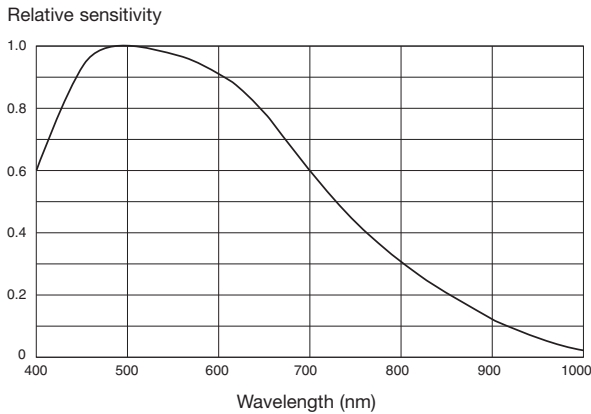

(Lens characteristics and light source characteristics excluded.)

Location and Function of Parts and Controls

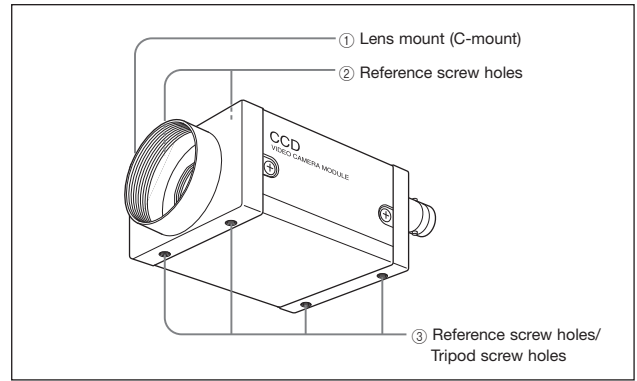

- ① **Lens mount (C-mount)**
Attach any C-mount lens or other optical equipment.

Note

The lens must not project more than 10 mm from the lens mount.

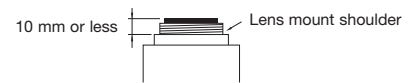

- ② **Reference holes (at the top)**
These precision screw holes are for locking the camera module. Locking the camera module using these holes secures the optical axis alignment.
- ③ **Reference screw holes/Tripod screw holes (at the bottom)**
These precision screw holes are for locking the camera module. Locking the camera module using these holes secures the optical axis alignment. You can install the camera on a tripod. To install on a tripod, you will need to install the VCT-ST70I tripod adaptor using the reference holes on the bottom of the camera.

Specifications

	XC-ST70	XC-ST50	XC-ST51	XC-ST30	XC-ST70CE	XC-ST50CE	XC-ST51CE	XC-ST30CE
Image device	2/3-type IT CCD	1/2-type IT CCD		1/3-type IT CCD	2/3-type IT CCD	1/2-type IT CCD		1/3-type IT CCD
Signal system	EIA				CCIR			
Effective picture elements (H) × (V)	768 × 494				752 × 582			
Effective lines (H) × (V)	752 × 485				736 × 575			
Cell size (H) × (V)	11.6 μm × 13.5 μm	8.4 μm × 9.8 μm		6.35 μm × 7.4 μm	11.6 μm × 11.2 μm	8.6 μm × 8.3 μm		6.5 μm × 6.25 μm
Horizontal frequency	15.734 kHz				15.625 kHz			
Vertical frequency	59.94 Hz				50 Hz			
Lens mount	C-mount							
Sync system	Internal/External							
External Sync system input/output ^{†1}	HD/VD (HD/VD level: 2 V to 5 Vp-p)							
External Sync frequency	±1% (in horizontal sync frequency), VS							
Jitter	less than ± 20 nsec (external horizontal frequency)							
Scanning system	2:1 Interlaced							
Video output	1.0 Vp-p, negative, 75 Ω unbalanced							
Horizontal resolution	525 TV lines				625 TV lines			
Sensitivity	400 lx, F8 (γ= ON, 0 dB)	400 lx, F11 (γ= ON, 0 dB)	400 lx, F5.6 (γ= ON, 0 dB)	400 lx, F8 (γ= ON, 0 dB)	400 lx, F11 (γ= ON, 0 dB)	400 lx, F5.6 (γ= ON, 0 dB)	400 lx, F11 (γ= ON, 0 dB)	400 lx, F5.6 (γ= ON, 0 dB)
Minimum illumination	0.3 lx (F1.4, AGC ON)	0.2 lx (F1.4, AGC ON)	0.3 lx (F1.4, AGC ON)	0.3 lx (F1.4, AGC ON)	0.2 lx (F1.4, AGC ON)	0.3 lx (F1.4, AGC ON)	0.2 lx (F1.4, AGC ON)	0.3 lx (F1.4, AGC ON)
S/N ratio	60 dB		56 dB		58 dB		54 dB	
Gain	AGC/Fixed/Manual (adjustable on the rear panel)							
Gamma	ON/OFF (adjustable on the rear panel)							
Normal shutter	1/100 sec to 1/10,000 sec				1/120 sec to 1/10,000 sec			
External trigger shutter	1/4 sec to 1/10,000 sec				1/4 sec to 1/8,000 sec			
Power requirements	DC 12 V (10.5 V to 15 V)							
Power consumption	2.1 W	2.0 W		1.9 W	2.1 W	2.0 W		1.9 W
Dimensions	44 (W) × 29 (H) × 57.5 (D) mm (not including projecting parts)							
Mass	105 g	110 g		105 g	110 g			
Operating temperature	-5°C to +45°C							
Storage temperature	-30°C to +60°C							
Performance guarantee temperature	0°C to 40°C							
Operating humidity	20% to 80% (no condensation)							
Storage humidity	20% to 95% (no condensation)							
Vibration resistance	10 G (20 Hz to 200 Hz) 20 minutes for each direction-x, y, z							
Shock resistance	70 G							
MTBF	70,600 hours (Approx. 8.1 years)							
Regulatory compliance	UL6500, FCC/ICES-003: Class B, CE: EN61326, AS/NZ: EN61326, KC: KN22/KN24: Class A							
Supplied accessories	Lens mount cap (1), Operating instructions (1)							

The values for mass and dimension are approximate.

^{†1} Automatic switching in response to the presence of an input signal when the switch on the rear panel is set to EXT.

Rear Panel

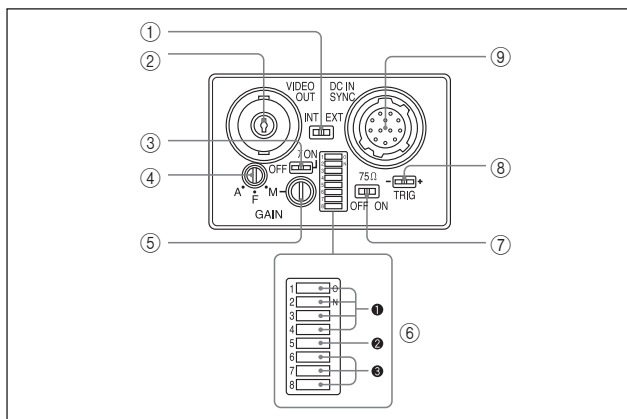

① HD/VD signal input/output switch

Set the switch to INT to output HD/VD signals from the camera module. Set the switch to EXT to input HD/VD signals from an external unit. (Factory setting: EXT)

② VIDEO OUT (Video signal output) connector (BNC)

You can use this connector for video signal output from the camera module.

③ γ compensation ON/OFF switch

Turn on this switch for γ compensation. (Factory setting: OFF)

④ GAIN switch

This switch selects AGC (A), fixed gain (F), or manual gain control (M). (Factory setting: F)

⑤ Manual gain control

Adjust the gain using this control. GAIN switch 4 must have been set to M (Manual).

⑥ Shutter speed/Mode setting DIP switch

① Shutter speed (bits 1 to 4)

Set an appropriate shutter speed. (Factory setting: Shutter off)

② High-rate scan mode switch (bit 5)

Factory setting: FRAME

③ Restart reset/External trigger shutter mode switch (bits 6 to 8)

Factory setting: Normal

Note

- Do not use any other settings for Restart reset/External trigger shutter mode except those shown on the next page. Using other settings may cause the camera to malfunction.
- If you set the External trigger shutter mode, set 0 in bits 1 to 4.

⑦ 75 Ω termination switch

Turn off if you do not terminate. (Factory setting: ON)

⑧ TRIG polarity switch

Select + or - according to the trigger pulse input from an external unit. (Factory setting: +)

⑨ DC IN/SYNC (DC power input/sync signal I/O) connector (12-pin)

Connect a CCXC-12P05N camera cable to this connector the +12 V DC power supply and the video signal output from the camera module. When a sync signal generator is connected to this connector, the camera module is synchronized with the external sync signals.

Factory Mode Settings of Rear Panel

No.	Switch	Factory setting mode
①	HD/VD signal input/output switch	EXT
③	Gamma compensation ON/OFF switch	OFF
④	GAIN switch	F
⑤	Manual gain control	- 1)
⑥	Shutter speed/Mode setting DIP switches	Shutter speed (bits 1 - 4)
		Potential accumulation mode (bit 5) Restart reset/External trigger shutter mode switch (bits 6 - 8)
⑦	75 Ω termination switch	ON
⑧	TRIG polarity switch	+

1) This unit is shipped from the factory with the GAIN switch being set to F (fix), so the Manual gain control knob is not operative unless the switch setting is changed. When the GAIN switch is set to M (manual), you can rotate this knob to adjust gain over the range 0 to 18 dB.

Connector Pin Assignments

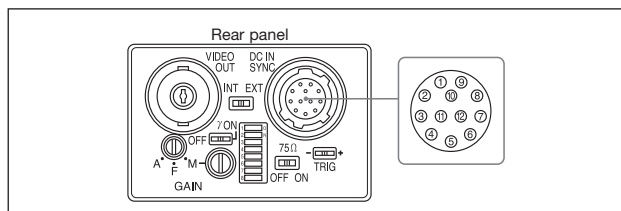

Pin No.	Camera sync output	External mode (VS)	External mode (VS)	Restart/Reset	External trigger shutter
1	Ground	Ground	Ground	Ground	Ground
2	+12 V DC	+12 V DC	+12 V DC	+12 V DC	+12 V DC
3	Video output (Ground)	Video output (Ground)	Video output (Ground)	Video output (Ground)	Video output (Ground)
4	Video output (Signal)	Video output (Signal)	Video output (Signal)	Video output (Signal)	Video output (Signal)
5	HD output (Ground)	HD input (Ground)	—	HD input (Ground)	HD input (Ground)
6	HD output (Signal)	HD input (Signal)	—	HD input (Signal)	HD input (Signal)
7	VD output (Signal)	VD input (Signal)	VS input (Signal)	Reset (Signal)	VD input (Signal)
8	—	—	—	—	—
9	—	—	—	—	—
10	—	—	—	—	WEN output (Signal)
11	—	—	—	—	Trigger pulse input (Signal)
12	VD output (Ground)	VD input (Ground)	VS input (Ground)	Reset (Ground)	Reset (Ground)*

* Common ground for pins 7, 10, and 11

About the Electronic Shutter

There are two shutter types: normal shutter and external trigger shutter. Select them with the DIP switches on the rear panel.

DIP Switches on the Rear Panel

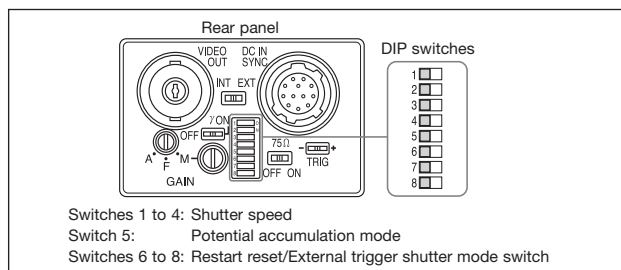

Switches 1 to 4: Shutter speed
Switch 5: Potential accumulation mode
Switches 6 to 8: Restart reset/External trigger shutter mode switch

Normal Shutter

This mode provides continuous video output with the electronic shutter selected by switches to capture a high-speed moving object clearly.

Normal shutter speed settings

Shutter OFF	1/125	1/250	1/500	1/1000
1 <input type="checkbox"/>	1 <input type="checkbox"/>	1 <input type="checkbox"/>	1 <input type="checkbox"/>	1 <input type="checkbox"/>
2 <input type="checkbox"/>	2 <input type="checkbox"/>	2 <input type="checkbox"/>	2 <input type="checkbox"/>	2 <input type="checkbox"/>
3 <input type="checkbox"/>	3 <input type="checkbox"/>	3 <input type="checkbox"/>	3 <input type="checkbox"/>	3 <input type="checkbox"/>
4 <input type="checkbox"/>	4 <input type="checkbox"/>	4 <input type="checkbox"/>	4 <input type="checkbox"/>	4 <input type="checkbox"/>
5 <input type="checkbox"/>	5 <input type="checkbox"/>	5 <input type="checkbox"/>	5 <input type="checkbox"/>	5 <input type="checkbox"/>
6 <input type="checkbox"/>	6 <input type="checkbox"/>	6 <input type="checkbox"/>	6 <input type="checkbox"/>	6 <input type="checkbox"/>
7 <input type="checkbox"/>	7 <input type="checkbox"/>	7 <input type="checkbox"/>	7 <input type="checkbox"/>	7 <input type="checkbox"/>
8 <input type="checkbox"/>	8 <input type="checkbox"/>	8 <input type="checkbox"/>	8 <input type="checkbox"/>	8 <input type="checkbox"/>
1/2000	1/4000	1/10000	Flickerless* 1/100 (EIA) 1/120 (CCIR)	
1 <input type="checkbox"/>	1 <input type="checkbox"/>	1 <input type="checkbox"/>	1 <input type="checkbox"/>	
2 <input type="checkbox"/>	2 <input type="checkbox"/>	2 <input type="checkbox"/>	2 <input type="checkbox"/>	
3 <input type="checkbox"/>	3 <input type="checkbox"/>	3 <input type="checkbox"/>	3 <input type="checkbox"/>	
4 <input type="checkbox"/>	4 <input type="checkbox"/>	4 <input type="checkbox"/>	4 <input type="checkbox"/>	
5 <input type="checkbox"/>	5 <input type="checkbox"/>	5 <input type="checkbox"/>	5 <input type="checkbox"/>	
6 <input type="checkbox"/>	6 <input type="checkbox"/>	6 <input type="checkbox"/>	6 <input type="checkbox"/>	
7 <input type="checkbox"/>	7 <input type="checkbox"/>	7 <input type="checkbox"/>	7 <input type="checkbox"/>	
8 <input type="checkbox"/>	8 <input type="checkbox"/>	8 <input type="checkbox"/>	8 <input type="checkbox"/>	

(Unit: second)

* If you set the mode to flickerless, the positions of DIP switches 1 to 3 are optional.

Note

The DIP switch 5 position is optional. (The field setting is recommended.) The field setting can obtain a sensitivity that is twice that of the frame setting.

External Trigger Shutter

Inputting an external trigger pulse enables the camera to capture fast-moving objects clearly with precise timing. Set DIP switches 6, 7, and 8 on the rear panel to Mode 1 or Mode 2. When you set the trigger pulse width to 1/3 of a second or more, the output signal changes to the normal VIDEO signal.

There are two modes for the timing in which video signals are obtained.

• Mode 1 (Non-reset mode)

- In this mode, a video signal synchronized with a VD signal is output after a trigger pulse is input.
- The video signal is synchronized with the external VD signal when an external HD/VD signal is input.
 - The video signal is synchronized with an internal VD signal when no external HD/VD signal is input.

• Mode 2 (Reset mode)

In this mode, an internal VD is reset, then a video signal is output a certain period of time after trigger pulse input.

To Set the External Trigger Shutter

There are two ways to set the shutter speed.

• Using the DIP switches on the rear panel

For shutter speeds, see the following table.

Mode 1 (Non-reset mode)				Mode 2 (Reset mode)			
1/100 (EIA) 1/120 (CCIR)	1/125	1/250	1/500	1/100 (EIA) 1/120 (CCIR)	1/125	1/250	1/500
1 <input type="checkbox"/>	1 <input type="checkbox"/>	1 <input type="checkbox"/>	1 <input type="checkbox"/>	1 <input type="checkbox"/>	1 <input type="checkbox"/>	1 <input type="checkbox"/>	1 <input type="checkbox"/>
2 <input type="checkbox"/>	2 <input type="checkbox"/>	2 <input type="checkbox"/>	2 <input type="checkbox"/>	2 <input type="checkbox"/>	2 <input type="checkbox"/>	2 <input type="checkbox"/>	2 <input type="checkbox"/>
3 <input type="checkbox"/>	3 <input type="checkbox"/>	3 <input type="checkbox"/>	3 <input type="checkbox"/>	3 <input type="checkbox"/>	3 <input type="checkbox"/>	3 <input type="checkbox"/>	3 <input type="checkbox"/>
4 <input type="checkbox"/>	4 <input type="checkbox"/>	4 <input type="checkbox"/>	4 <input type="checkbox"/>	4 <input type="checkbox"/>	4 <input type="checkbox"/>	4 <input type="checkbox"/>	4 <input type="checkbox"/>
5 <input type="checkbox"/>	5 <input type="checkbox"/>	5 <input type="checkbox"/>	5 <input type="checkbox"/>	5 <input type="checkbox"/>	5 <input type="checkbox"/>	5 <input type="checkbox"/>	5 <input type="checkbox"/>
6 <input type="checkbox"/>	6 <input type="checkbox"/>	6 <input type="checkbox"/>	6 <input type="checkbox"/>	6 <input type="checkbox"/>	6 <input type="checkbox"/>	6 <input type="checkbox"/>	6 <input type="checkbox"/>
7 <input type="checkbox"/>	7 <input type="checkbox"/>	7 <input type="checkbox"/>	7 <input type="checkbox"/>	7 <input type="checkbox"/>	7 <input type="checkbox"/>	7 <input type="checkbox"/>	7 <input type="checkbox"/>
8 <input type="checkbox"/>	8 <input type="checkbox"/>	8 <input type="checkbox"/>	8 <input type="checkbox"/>	8 <input type="checkbox"/>	8 <input type="checkbox"/>	8 <input type="checkbox"/>	8 <input type="checkbox"/>
1/1000	1/2000	1/4000	1/10000 (EIA) 1/8000 (CCIR)	1/1000	1/2000	1/4000	1/10000 (EIA) 1/8000 (CCIR)
1 <input type="checkbox"/>	1 <input type="checkbox"/>	1 <input type="checkbox"/>	1 <input type="checkbox"/>	1 <input type="checkbox"/>	1 <input type="checkbox"/>	1 <input type="checkbox"/>	1 <input type="checkbox"/>
2 <input type="checkbox"/>	2 <input type="checkbox"/>	2 <input type="checkbox"/>	2 <input type="checkbox"/>	2 <input type="checkbox"/>	2 <input type="checkbox"/>	2 <input type="checkbox"/>	2 <input type="checkbox"/>
3 <input type="checkbox"/>	3 <input type="checkbox"/>	3 <input type="checkbox"/>	3 <input type="checkbox"/>	3 <input type="checkbox"/>	3 <input type="checkbox"/>	3 <input type="checkbox"/>	3 <input type="checkbox"/>
4 <input type="checkbox"/>	4 <input type="checkbox"/>	4 <input type="checkbox"/>	4 <input type="checkbox"/>	4 <input type="checkbox"/>	4 <input type="checkbox"/>	4 <input type="checkbox"/>	4 <input type="checkbox"/>
5 <input type="checkbox"/>	5 <input type="checkbox"/>	5 <input type="checkbox"/>	5 <input type="checkbox"/>	5 <input type="checkbox"/>	5 <input type="checkbox"/>	5 <input type="checkbox"/>	5 <input type="checkbox"/>
6 <input type="checkbox"/>	6 <input type="checkbox"/>	6 <input type="checkbox"/>	6 <input type="checkbox"/>	6 <input type="checkbox"/>	6 <input type="checkbox"/>	6 <input type="checkbox"/>	6 <input type="checkbox"/>
7 <input type="checkbox"/>	7 <input type="checkbox"/>	7 <input type="checkbox"/>	7 <input type="checkbox"/>	7 <input type="checkbox"/>	7 <input type="checkbox"/>	7 <input type="checkbox"/>	7 <input type="checkbox"/>
8 <input type="checkbox"/>	8 <input type="checkbox"/>	8 <input type="checkbox"/>	8 <input type="checkbox"/>	8 <input type="checkbox"/>	8 <input type="checkbox"/>	8 <input type="checkbox"/>	8 <input type="checkbox"/>

(Unit: second)

• Using trigger pulse width

Set all DIP switches (1 to 4 on the rear panel) to 0. You can obtain an arbitrary shutter speed by setting the trigger pulse width within the range of 2 μ s to 250 ms.

Mode 1 (Non-reset mode)

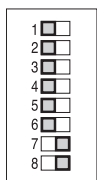

Mode 2 (Reset mode)

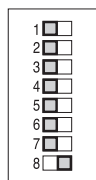

$$\text{Exposure time} = \text{Trigger pulse width} + 97 \mu\text{s (EIA)}$$

$$\text{Trigger pulse width} + 120 \mu\text{s (CCIR)}$$

Note

- The DIP switch 5 position is optional. (The field setting is recommended.) The field setting can obtain a sensitivity that is twice that of the frame setting.
- If you input another trigger pulse before the video signal output for the previous trigger pulse is completely output, an incorrect video signal will be output.

Specifications of trigger pulse

- When using a trigger pulse like shown below, set the TRIG polarity selector switch on the rear panel to + :

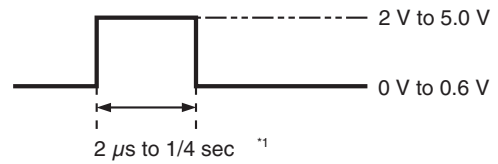

*1 If you set the trigger pulse with the DIP switches, use the 100 μ s to 1/4 sec pulse width.

- When using a trigger pulse like shown below, set the TRIG polarity selector switch on the rear panel to - :

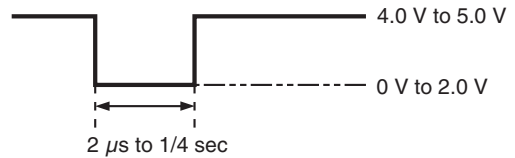

- Input impedance: 10 k Ω or more.
- The voltage and pulse width used are measured at pin 11 of a 12-pin multi-connector on the rear panel.

Restart/Reset

To Set Restart/Reset Mode

The information on one screen can be extracted at any time by externally inputting Restart/Reset signals (HD/VD). To enter this mode, set the trigger shutter switches (6 to 8) on the rear panel of the camera as shown in the figure. The Reset/Restart mode is especially effective for frame image output with long exposure or a strobe light.

DIP switches

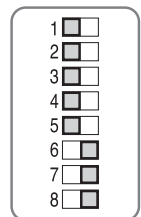

Long Exposure

The Restart/Reset function extends the CCD accumulation time, resulting in highly sensitive image capture. This function is effective when you cannot gain satisfactory sensitivity under normal operating conditions, or when you want to observe the trail of a moving object. Extend the VD interval (T) between external VD pulses.

Sample input timing chart 1

