

New Series

NEW

B/W model	Color model
XCL-C500	XCL-C500C
XCL-C280	XCL-C280C
XCL-C130	XCL-C130C
XCL-C32	XCL-C32C
XCL-C30	XCL-C30C



CAMERA Link

PoCL

CL Output	Progressive Scan	2/3 Type CCD	1/1.8 Type CCD	1/3 Type CCD	1/2 Type CCD	Square Pixels	C Lens Mount
5 Mega CCD	2.8 MEGA Output	SXGA Output	VGA Output	Long Exposure	Normal Shutter	External Trigger Shutter	Auto Shutter
Bulk Trigger	Sequential Trigger	Partial Scan	Shading Correction	Temperature Readout	Blemish Correction	One-Push White Balance	Manual White Balance
LUT	RS232C Control	B/W	RGB RAW	Near-IR Sensitivity	Connection Diagram PSB		

*1: XCL-C500/C500C *2: XCL-C280/C280C *3: XCL-C130/C130C/C30/C30C
 *4: XCL-C32/C32C *5: XCL-C130/C130C *6: XCL-C32/C32C/C30/C30C
 *7: XCL-C500/C280/C130/C32/C30 *8: XCL-C500C/C280C/C130C/C32C/C30C
 *9: XCL-C280

Outline

The XCL-C Series cameras incorporate compactly various features and some Sony's unique features including Shading Correction with its cubic shaped-design. With high frame rate performance, the XCL-C Series lineup consists of 10 models ranging from VGA to 5 Mega model in monochrome and color versions.

Features

High frame rate

CCD • Output pixels		Frame rate	B/W Model	Color Model
1/3-type CCD	VGA	130 fps	XCL-C30	XCL-C30C
1/2-type CCD	VGA	104 fps	XCL-C32	XCL-C32C
1/3-type CCD	SXGA	31 fps	XCL-C130	XCL-C130C
1/1.8-type CCD	2.8 Mega	26 fps	XCL-C280	XCL-C280C
2/3-type CCD	5 Mega	15 fps	XCL-C500	XCL-C500C

Near-infrared Sensitivity: XCL-C280

Utilizing "EXview HAD CCD II" technology, it enables the XCL-C280 to capture clear images in lowlight environments.

Shading Correction

Shadings caused by a drop in the amount of light around the lens or light source variation are corrected. Three sets of user settings can be saved.

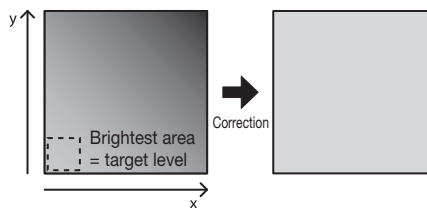

Temperature Readout

The camera's internal temperature can be read from the temperature sensor installed in the circuit board.

Defect correction

It corrects clear defect points and opaque defect points which increase under the high/low temperature or when exposed for a long time (seconds). From the peripheral pixels, correction is performed on coordinate pixels in which defects are detected. Factory setting and user setting can be selected.

* Factory setting: OFF

Trigger modes

Free run/Special trigger mode
(Bulk trigger/Sequential trigger)

Readout modes

Normal/Binning (Monochrome camera only)/Partial scan

Binning (Monochrome camera only)

<Vertical Binning/Horizontal Binning>
By adding 2 vertical pixels or 2 horizontal pixels, the frame rate in vertical binning is increased along with the sensitivity. The color camera cannot set this. This can be set with or without a trigger. Partial scan can be used concurrently and horizontal and vertical can be set at the same time.

* The XCL-C500 can perform vertical binning only when Height is ≥ 2048.

Partial scan

Only the area selected from the effective pixel area can be read out. Clearing unnecessary parts at high-speed allows high-speed reading. The area size is selected by the HEIGHT and WIDTH commands, and the read beginning point is selected by the OFFSETX and OFFSETY commands.

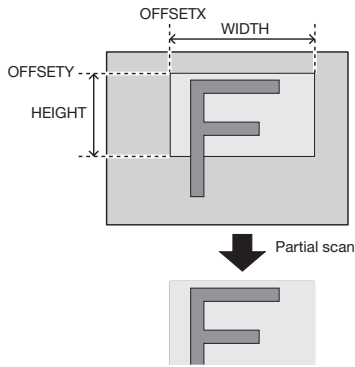

Configurable range

	WIDTH	HEIGHT
XCL-C30/C30C	16 to 658	2 to 494
XCL-C32/C32C	16 to 658	2 to 494
XCL-C130/C130C	16 to 1296	2 to 966
XCL-C280/C280C	16 to 1940	2 to 1460
XCL-C500/C500C	16 to 2456	480 to 2058

* Configurable values
The values of OFFSETX, OFFSETY, WIDTH and HEIGHT increase or decrease in steps of 2.

- Shutter: Manual/External trigger shutter/Auto
- Shutter speed: 1/100,000 sec to 2 sec
- Synchronization: Hardware trigger, Software trigger
- White balance (color camera only)
 - One push WB
The white balance can be automatically adjusted once when the WHITEBALANCE-AUTO command is executed. The detection area is set to the screen center by default. The detection frame can be changed arbitrarily (AWB-FRAME).
 - Manual
Each Gain of R, G, and B is adjustable manually.
- Readout features
 - Built-in test pattern
B/W model: monochrome chart
Color model: monochrome chart/color chart
 - LUT (Look-Up Table)
The following Five types of presets are provided. Binarization, 5-point interpolation, and arbitrary setting can be changed. LUT off, Reverse, Binarization, 5-point interpolation, Arbitrary setting.

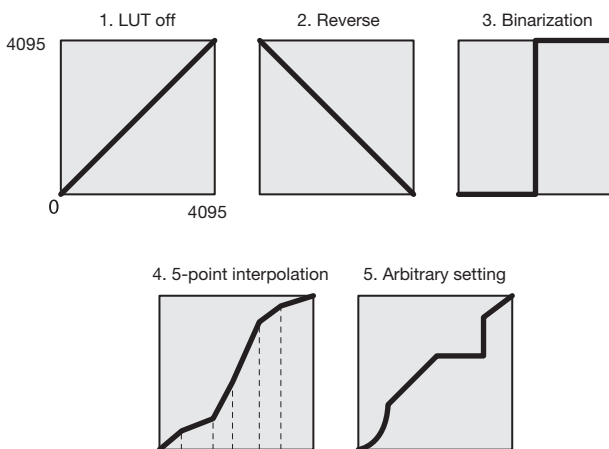

■ Camera Link Tap

1tap output or 2tap output can be selected, regardless of the camera settings. Output clock frequencies are as follows.

	param	XCL-C30 XCL-C30C	XCL-C32 XCL-C32C	XCL-C130 XCL-C130C	XCL-C280 XCL-C280C	XCL-C500 XCL-C500C
CAMERALINK-TAP	1	50 MHz	40 MHz	50 MHz	81 MHz	80 MHz
	2	25 MHz	20 MHz	25 MHz	40.5MHz	40 MHz

* The camera link cable can be extended when the 2tap output is selected. However, the 2tap output can't be selected when RGB 24 bit output mode is selected.

* Factory setting: 2tap output

■ CameraLink: PoCL/non-PoCL

■ Compact Design: 29 (W) × 29 (H) × 30 (D) mm, approx. 200 g

■ C-mount

■ High Shock and Vibration Resistance

Accessories

■ Compact camera adaptor
DC-700/700CE

■ 12-pin camera cable (CE standard)

CCXC-12P02N (2 m)

CCXC-12P05N (5 m)

CCXC-12P10N (10 m)

CCXC-12P25N (25 m)

■ Tripod adaptor
VCT-333I

Dimensions

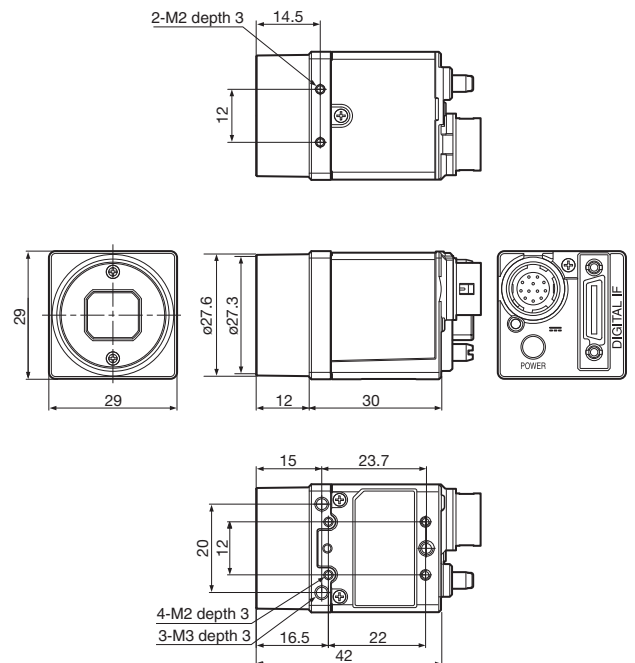

Unit: mm

Specifications

B/W model

	XCL-C30	XCL-C32	XCL-C130	XCL-C280	XCL-C500
Camera					
Image size	VGA	VGA	SXGA	2.8 Mega	5 Mega
Image sensor	1/3-type PS IT CCD	1/2-type PS IT CCD	1/3-type PS IT CCD	1/1.8-type PS IT CCD	2/3-type PS IT CCD
Number of effective pixels (H) × (V)	659 × 494	659 × 494	1,296 × 966	1,940 × 1,460	2,456 × 2,058
Cell size (H) × (V)	7.4 μm × 7.4 μm	9.9 μm × 9.9 μm	3.75 μm × 3.75 μm	3.69 μm × 3.69 μm	3.45 μm × 3.45 μm
Standard output pixels (H) × (V)	640 × 480	640 × 480	1,280 × 960	1,920 × 1,440	2,448 × 2,048
Color filter	—	—	—	—	—
Frame rate	130 fps	104 fps	31 fps	26 fps	15 fps
Minimum illumination	1.5 lx (Iris: F1.4, Gain: 18 dB, Shutter: 1/90 s)	1.0 lx (Iris: F1.4, Gain: 18 dB, Shutter: 1/60 s)	0.5 lx (Iris: F1.4, Gain: 18 dB, Shutter: 1/30 s)	0.5 lx (Iris: F1.4, Gain: 18 dB, Shutter: 1/25 s)	0.5 lx (Iris: F1.4, Gain: 18 dB, Shutter: 1/15 s)
Sensitivity	F5.6 (400 lx, Gain: 0 dB)	F5.6 (400 lx, Gain: 0 dB)	F5.6 (400 lx, Gain: 0 dB)	F5.6 (400 lx, Gain: 0 dB)	F8 (400 lx, Gain: 0 dB)
SNR	1 step (Lens close, Gain: 0 dB, 8 bits)				
Gain	Auto, Manual: 0 dB to 18 dB				
Shutter speed	Auto, Manual: 2 sec to 1/100,000 sec in 1 μs increments				
Reference video output level	3,760 steps (12-bit)				
Reference pedestal level	256 steps (12-bit)			240 steps (12-bit)	
Camera Features					
Readout modes	Normal, Binning (2 × 1, 1 × 2, 2 × 2), Partial scan				
Readout features	LUT (Binarization, Gamma (arbitrary setting), Test pattern (monochrome chart))				
Synchronization	Internal/External (Hardware trigger, Software trigger)				
Trigger modes	OFF (Free run), ON (Trigger edge detection, Trigger width detection), Special trigger (Bulk/Sequential)				
User Set/Memory channel	16 channels				
User memory	32 kbytes + 64 bytes × 16 ch				
Partial scan	W (Pixel)	16 to 658	16 to 1296	16 to 1940	16 to 2456
	H (Line)	2 to 494	2 to 966	2 to 1460	480 to 2058
GPO	EXPOSURE/Strobe/LVAL/FVAL/Sensor readout/Trigger through/Pulse generation signal/User definition 1, 2, 3 (Selectable)				
Other features	Shading correction, Defect correction, Temperature readout, Sensor tap switching*				
Interface					
Video data output	digital Mono, 8, 10, 12 bit (default setting 8 bit)				
Digital interface	LVDS				
Camera specification	PoCL, Base Configuration, CameraLink® Version 1.2				
Output data clock	50 MHz (1 tap)	40 MHz (1 tap)	50 MHz (1 tap)	81 MHz (1 tap)	80 MHz (1 tap)
	25 MHz (2 tap)	20 MHz (2 tap)	25 MHz (2 tap)	40.5 MHz (2 tap)	40 MHz (2 tap)
Digital I/O	TTL IN (3x), TTL OUT (3x)				
General					
Lens mount	C-mount				
Flange focal length	17.526 mm				
Power requirements	DC +12 V (10.5 V to 5.0 V: DC IN terminal/ 10 V to 13 V: Digital IF terminal)				
Power consumption	2.8 W		2.4 W	3.0 W	3.2 W
Operating temperature	-5°C to +45°C				
Performance guarantee temperature	0°C to 40°C				
Storage temperature	-30°C to +60°C				
Operating humidity	20% to 80% (no condensation)				
Storage humidity	20% to 95% (no condensation)				
Vibration resistance	10 G (20 Hz to 200 Hz)				
Shock resistance	70 G				
Dimensions (W × H × D)	29 × 29 × 30 mm (not including projecting parts)				
Mass	56 g				
Regulations	UL60950, FCC Class A, CSA C22.2-No.1, IC Class A Digital Device, CE: EN61326 (Class A), AS EMC: EN61326, VCCI Class A, KCC				
Supplied accessories	Lens mount cap (1), Operating Instructions (1)				

*XCL-C280 only

Color model

	XCL-C30C	XCL-C32C	XCL-C130C	XCL-C280C	XCL-C500C
Camera					
Image size	VGA	VGA	SXGA	2.8 Mega	5 Mega
Image sensor	1/3-type PS IT CCD	1/2-type PS IT CCD	1/3-type PS IT CCD	1/1.8-type PS IT CCD	2/3-type PS IT CCD
Number of effective pixels (H) × (V)	659 × 494	659 × 494	1,296 × 966	1,940 × 1,460	2,456 × 2,058
Cell size (H) × (V)	7.4 μm × 7.4 μm	9.9 μm × 9.9 μm	3.75 μm × 3.75 μm	3.69 μm × 3.69 μm	3.45 μm × 3.45 μm
Standard output pixels (H) × (V)	640 × 480	640 × 480	1,280 × 960	1,920 × 1,440	2,448 × 2,048
Color filter	Color moxaic				
Frame rate	130 fps	104 fps	31 fps	26 fps	15 fps
Minimum illumination	15 lx (Iris: F1.4, Gain: 18 dB, Shutter: 1/90 s)	12 lx (Iris: F1.4, Gain: 18 dB, Shutter: 1/60 s)	12 lx (Iris: F1.4, Gain: 18 dB, Shutter: 1/30 s)	10 lx (Iris: F1.4, Gain: 18 dB, Shutter: 1/25 s)	8 lx (Iris: F1.4, Gain: 18 dB, Shutter: 1/15 s)
Sensitivity	F5.6 (2,000 lx, Gain: 0 dB)	F5.6 (2,000 lx, Gain: 0 dB)	F5.6 (2,000 lx, Gain: 0 dB)	F5.6 (2,000 lx, Gain: 0 dB)	F8 (2,000 lx, Gain: 0 dB)
SNR	1 step (Lens close, Gain: 0 dB, 8 bits)				
Gain	Auto, Manual: 0 dB to 18 dB				
Shutter speed	Auto, Manual: 2 sec to 1/100,000 sec in 1 μs increments				
White balance	Manual, One push				
Reference video output level	3,760 steps (12-bit)				
Reference pedestal level	256 steps (12-bit)			240 steps (12-bit)	
Camera Features					
Readout modes	Normal, Partial scan				
Readout features	LUT (Binarization, Gamma (arbitrary setting), Test pattern (Monochrome chart/color chart)				
Synchronization	Internal/External (Hardware trigger, Software trigger)				
Trigger modes	OFF (Free run), ON (Trigger edge detection, Trigger width detection), Special trigger (Bulk/Sequential)				
User Set/Memory channel	16 channels				
User memory	32 kbytes + 64 bytes × 16 ch				
Partial scan	W (Pixel)	16 to 658	16 to 1296	16 to 1940	16 to 2456
	H (Line)	2 to 494	2 to 966	2 to 1460	480 to 2058
GPO	EXPOSURE/Strobe/LVAL/FVAL/Sensor readout/Trigger through/Pulse generation signal/User definition 1, 2, 3 (Selectable)				
Other features	Shading correction, Defect correction, Temperature readout, Sensor tap switching*				
Interface					
Video data output	digital Raw, 8, 10, 12 bit (default setting Raw 8 bit), RGB				
Digital interface	LVDS				
Camera specification	PoCL, Base Configuration, CameraLink® Version 1.2				
Output data clock	50 MHz (1 tap)	40 MHz (1 tap)	50 MHz (1 tap)	81 MHz (1 tap)	80 MHz (1 tap)
	25 MHz (2 tap)	20 MHz (2 tap)	25 MHz (2 tap)	40.5 MHz (2 tap)	40 MHz (2 tap)
Digital I/O	TTL IN (3x), TTL OUT (3x)				
General					
Lens mount	C-mount				
Flange focal length	17.526 mm				
Power requirements	DC +12 V (10.5 V to 5.0 V: DC IN terminal/ 10 V to 13 V: Digital IF terminal)				
Power consumption	2.8 W		2.4 W	3.0 W	3.2 W
Operating temperature	-5°C to +45°C				
Performance guarantee temperature	0°C to 40°C				
Storage temperature	-30°C to +60°C				
Operating humidity	20% to 80% (no condensation)				
Storage humidity	20% to 95% (no condensation)				
Vibration resistance	10 G (20 Hz to 200 Hz)				
Shock resistance	70 G				
Dimensions (W × H × D)	29 × 29 × 30 mm (not including projecting parts)				
Mass	56 g				
Regulations	UL60950, FCC Class A, CSA C22.2-No.1, IC Class A Digital Device, CE: EN61326 (Class A), AS EMC: EN61326, VCCI Class A, KCC				
Supplied accessories	Lens mount cap (1), Operating Instructions (1)				

*XCL-C280 only

Spectral Sensitivity Characteristics

B/W model

• **XCL-C30** (Lens characteristics and light source characteristics excluded.)

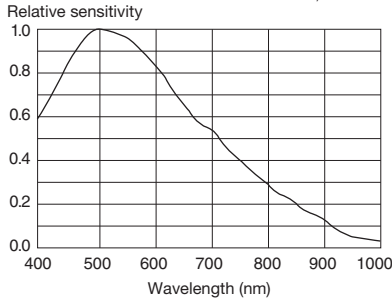

• **XCL-C32** (Lens characteristics and light source characteristics excluded.)

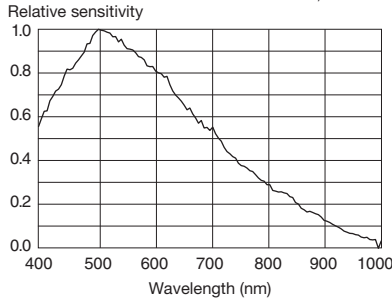

• **XCL-C130** (Lens characteristics and light source characteristics excluded.)

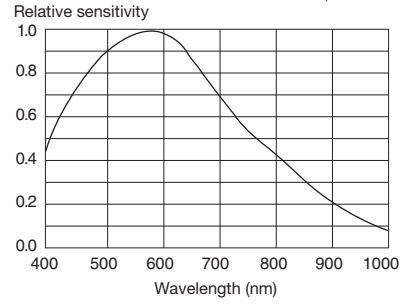

• **XCL-C280** (Lens characteristics and light source characteristics excluded.)

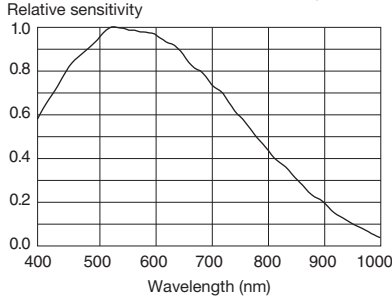

• **XCL-C500** (Lens characteristics and light source characteristics excluded.)

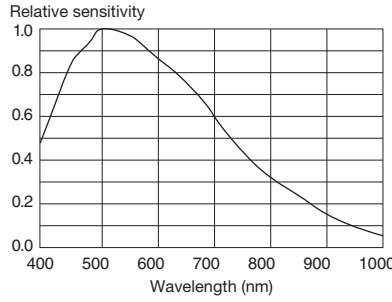

Color model

• **XCL-C30C** (Lens characteristics and light source characteristics excluded.)

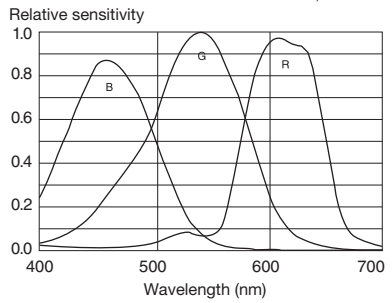

• **XCL-C32C** (Lens characteristics and light source characteristics excluded.)

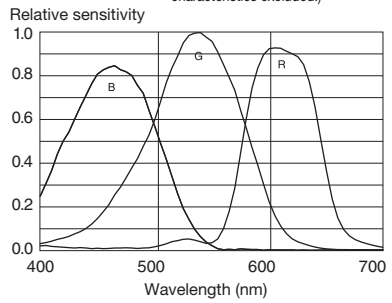

• **XCL-C130C** (Lens characteristics and light source characteristics excluded.)

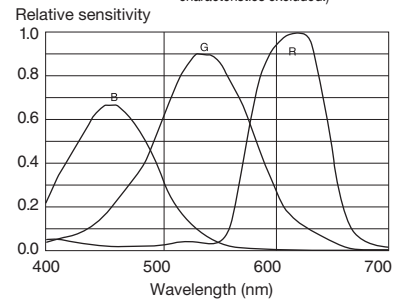

• **XCL-C280C** (Lens characteristics and light source characteristics excluded.)

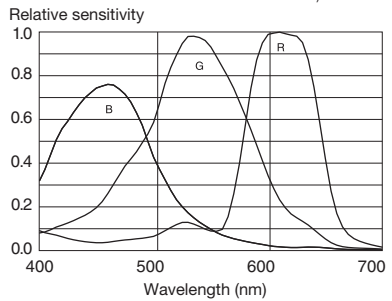

• **XCL-C500C** (Lens characteristics and light source characteristics excluded.)

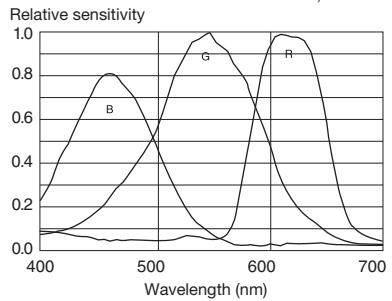

Digital Video Camera
XCL
XCG
XCD

Intelligent
XCI

Analog Video Camera
XC (Non-TV Format)
XC (TV Format)

Accessories

Color Camera Module
FCB

Color PTZ Camera
EVI

Location and Function of Parts and Controls

- ① **Lens mount (C-mount)**
Attach any C-mount lens or other optical equipment.

Note

The lens must not project more than 10 mm from the lens mount.

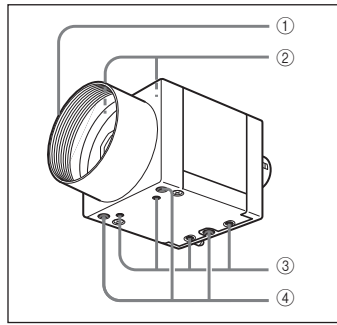
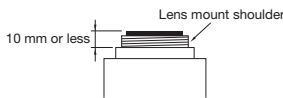

- ② **Guide screw holes (Top)**
③ **Guide screw holes/Tripod screw holes (bottom)**
When using a tripod, use these four screw holes to attach a VCT-333I tripod adaptor.
④ **Reference screw holes (bottom)**
These precision screw holes are for locking the camera module. Locking the camera module into these holes secures the optical axis alignment.

Rear Panel/Pin Assignments

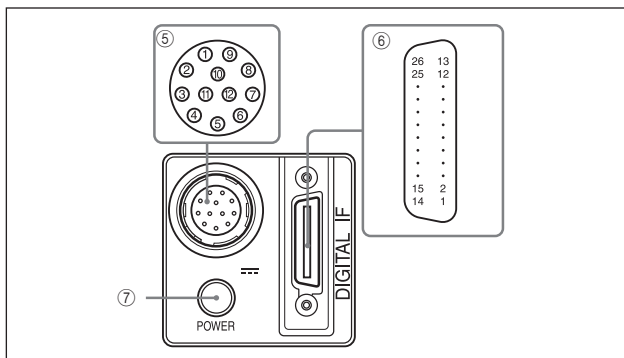

- ⑤ **DC IN (DC power input) connector (12-pin)**

Pin No.	Signal	Pin No.	Signal
1	Ground	7	GPI3 *2
2	DC12V	8	Ground
3	Ground	9	GPO3 *1
4	GPO1 *1	10	GPI2 *2
5	Ground	11	GPI1 *2
6	GPO2 *1	12	Ground

- *1 **Signal output from pin 4, 6, 9 (GPO1/2/3) of DC IN connector**

This setting allows you to select from exposure signal, strobe control signal, Hi/Low fixed value, etc. The initial values of GPO1/2/3 are all Hi fixed.

- *2 **Signal output from pin 7, 10, 11 (GPI3/2/1) of DC IN connector**

Function as GPI input or trigger input. The initial setting is GPI1 for trigger input and GPI2/3 for GPI input.

- ⑥ **DIGITAL IF (Interface) connector (26-pin miniconnector)**

Camera Link Base Configuration:

Pin No.	Signal	Pin No.	Signal
1	Power supply or Ground*	14	Ground
2	X0-	15	X0+
3	X1-	16	X1+
4	X2-	17	X2+
5	XCLK-	18	XCLK+
6	X3-	19	X3+
7	SerTC+	20	SerTC-
8	SerTFG-	21	SerTFG+
9	CC1-	22	CC1+
10	CC2+	23	CC2-
11	CC3-	24	CC3+
12	CC4+	25	CC4-
13	Ground	26	Power supply or Ground*

- ***About the 1st pin and 26th pin of the DIGITAL IF connector**

The connection differs depending on the type of camera module interface board you use.

In the case of PoCL support:

Both the 1st pin and 26th pin are Power supply

In the case of non-PoCL support:

Both the 1st pin and 26th pin are Ground

- ⑦ **Status LED (Green)**

When power is supplied to the camera, this button is lit. Various settings are available, such as to light up when interlocking with the trigger signal.

Connecting the Cables

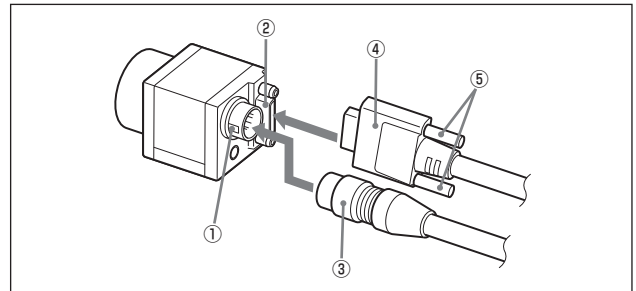

Connect the camera cable to the DC IN connector and the Camera Link cable to the DIGITAL IF cable respectively. If you use a camera module interface board with support for PoCL, you can operate the camera even if you do not connect the camera cable to the DC IN connector. When you connect the Camera Link cable, turn the two fastening screws on the connector to secure the cable tightly. Connect the other end of the camera cable to the DC-700/700CE and the other end of the Camera Link cable to the camera module interface board.

- ① DC IN Connector ② DIGITAL IF (Interface) Connector
③ Camera Cable ④ Camera Link Cable ⑤ Fastening Screws

Note

When using the camera with a PoCL connection, make sure you connect a PoCL compatible cable. Connecting a cable that is not compatible with PoCL (non-PoCL) may cause a malfunction of the camera or camera module interface board.

Controlling the Camera From the Host Device

You can control the camera from host device such as a computer. The following table shows the major control functions.

Control functions	Description	
Operating mode	Free run/Trigger	
Shutter speed	Free run	2 sec to 1/100,000 sec
	Trigger edge detection	2 sec to 1/100,000 sec
	Trigger pulse width detection	Setting by trigger pulse width
Gain	0 dB to 18 dB	
Partial Scan	Variable, 2-line increments (more than 480 lines for XCL-C500)	
LUT (Look Up Table)	OFF/ON (Mode: 5 types)	
External trigger input	DIGITAL IF connector/DC IN connector	
Video output switch	Monochrome model: Mono 8/10/12-bit Color model: Raw 8/10/12-bit, RGB 24-bit	
Binning (Monochrome camera only)	2 × 1, 1 × 2, 2 × 2	
Defect correction	OFF/ON	
Shading correction	OFF/ON	

Trigger Signal Input

Trigger signals can be input via the 7th, 10th, 11th pins of the DC IN connector, the CC1, CC2, CC3, CC4 pins of the Digital IF connector, or the software command. Switchover of the trigger signal can be changed via the TRG-SRC command.

command	param	Trigger signal assigned pin
TRG-SRC	7	DC IN connector 7th pin (GPI3)
	10	DC IN connector 10th pin (GPI2)
	11	DC IN connector 11th pin (GPI1)
	101	Digital IF connector 22nd [+] / 9th [-] (CC1)
	102	Digital IF connector 10th [+] / 23rd [-] (CC2)
	103	Digital IF connector 24th [+] / 11th [-] (CC3)
	104	Digital IF connector 12th [+] / 25th [-] (CC4)
	0	Software command (TRG-SOFT)
	20	OR of GPI1/GPI2/GPI3

Trigger Signal Specifications

DC IN connector specification

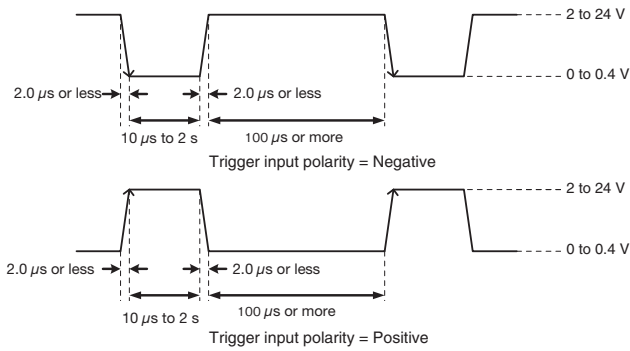

Digital IF connector specifications

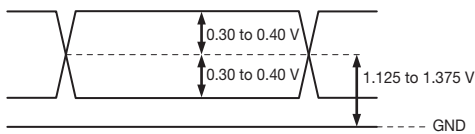

Note

When inputting a trigger signal to the camera using the DC-700/CE, use DC 5 V or less at the logical high level.

Trigger Modes

There are three modes, Free run, Special trigger (Bulk Trigger/Sequential Trigger).

The camera operates without a trigger signal and performs the video output operation continuously after the shutter (exposure) is finished when operating in Free run mode.

- Trigger edge detection (Polarity: positive)



- Trigger width detection (Polarity: positive)

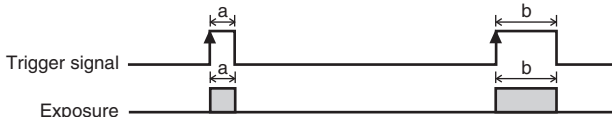

Bulk Trigger

Different camera setting configurations are stored in memory channels beforehand, with the different settings applied to acquire multiple video images at each trigger event. In the following diagram, two images are acquired in one cycle.

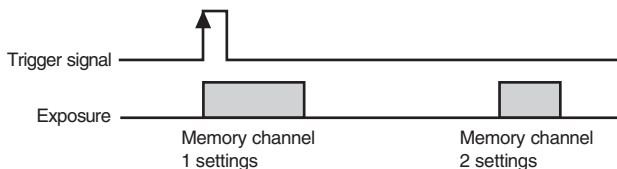

Sequential Trigger

Different camera setting configurations are stored in memory channels beforehand, with the different settings applied in sequence to acquire a different image with each trigger event. In the following diagram, two images with different exposure settings are acquired in one cycle.

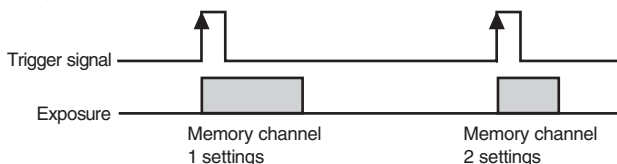

External Trigger Signals and Timing of Shooting

In Trigger Edge mode, the time from when detecting a trigger signal to when starting exposure is 0.7 to 1.5 μ s (differ depending on the camera). In Trigger Width mode, "Minimum Delay" operation (0.7 to 1.7 μ s) or "Exact Exposure Time" operation can be selected.

Trigger Inhibition

Trigger input can be disabled. This function is effective when disabling the trigger signal to a specific camera in the environment where multiple cameras are connected by the same trigger signal and when preventing false operations caused by noise contamination to the trigger signal line (due to the installed environment).

- Exposure condition (detecting the drop edge):

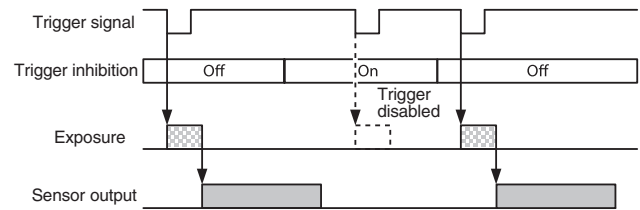

Trigger Shift

This device can accept exposure by the next trigger even while a video is output (except for the special trigger operation). In this case, the trigger signal can become a noise source. When trigger shift is enabled, adjustment is made automatically for operations from trigger input to exposure to prevent noise contamination. (The time from trigger input to exposure start will be delayed up to 1 line.)

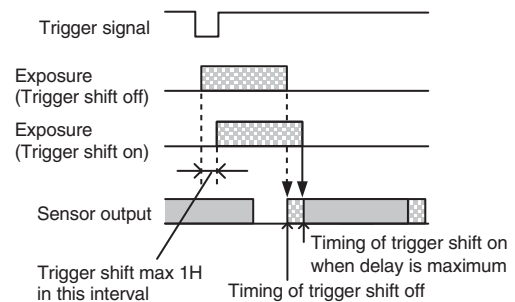

Trigger Delay

The camera can delay the trigger signal.

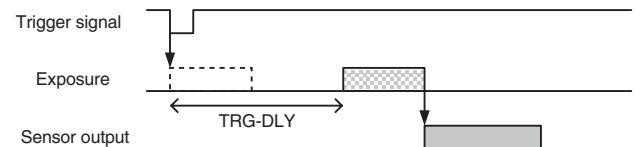

Trigger Range Limit

Only signals in the set trigger width can be accepted as the trigger signal. This functions as a noise filter, which removes chattering or disturbance noise in the trigger signal line. This also functions as a trigger selector, whereby only a specific camera can be operated by the trigger when multiple cameras share one trigger signal line.

User Set

Main set values can be saved to the channels 1 to 16 of USERSET. User set is available during special trigger mode (Bulk Trigger/Sequential Trigger).

Gain

The camera provides both manual and automatic gain control.

Manual gain control

This manual gain control can be variably set from 0 to 18 dB in 1 dB unit, or 0.0358 dB steps.

In addition to the above, the XCL-C280/C280C/C500/C500C provides independent left and right controls (GainL and GainR).

Auto gain control

The camera provides the auto gain control function to automatically control image brightness according to a user-specified detection frame and image average level (variable from 0 to 16383 in 14 bit). The variable range is the same as for manual gain control. Also, the auto gain control detection frame showing each area's image average level can be displayed and adjusted. The detection frame is defined by Offset X and Y, Width and Height percentage values (relative to the [100%] width and height of the output video image).

Switching Sensor Tap

XCL-C280/C280C has a CCD with 2-channel output. Reading speed is faster in 2-channel output than 1-channel output. Although XCL-C500/C500C has a CCD with 2-channel output, the number of sensor taps cannot be switched.

GPIO

GPI

The value can be checked by detecting the signals input to the DC IN connector 7th, 10th, and 11th using the GPI command. Since all pins are pulled up, 1 (Hi level) is returned if they are opened.

GPO

GPO1, GPO2, and GPO3 outputs can be transmitted from the DC IN connector 4th, 6th, and 9th pins, respectively. After selecting a signal, the output polarity should be determined by GPO-INVERTER. The strobe control signal can be set separately for GPO1, GPO2, and GPO3.

command	param1	param2	Setting
GPO-SRC	4/6/9	0	Exposure signal
		1	Strobe control signal
		2	LVAL signal
		3	FVAL signal
		4	Sensor readout signal
		5	Trigger through signal
		6	Pulse generation signal
		7	User definition 1
		8	User definition 2
9	User definition 3		